



# Operation **Manual**

## **SV-DA200** **AC servo drives**



## Preface

Thanks for selecting SV-DA200 servo drives.

SV-DA200 series products apply the modular structure with extension functions and better performance. The upper PC uses high speed USB communication, the bus control can select 485 communication and CANopen communication and PROFIBUS-DP and EtherCAT can be extended by the extension card. And the product has functions of online/offline inertia identification, gain adjustment, automatic/manual notch filter, automatic/manual vibration control filter, internal position control, full closed loop control, security terminal STO, various encoder input, 4M pulse input and so on.

SV-DA200 drive has the electromagnetic compatibility design which can meet the strong electromagnetic interference resistance demand of environmental protection and low noise and weakening electromagnetic interference in the application sites for the customers.

This manual provides installation and configuration, parameters setting, fault diagnoses and daily maintenance and relative precautions to customers. Please read this manual carefully before the installation to ensure a proper installation and operation and high performance of SV-DA200 drives.

If the product is ultimately used for military affairs or manufacture of weapon, it will be listed on the export control formulated by *Foreign Trade Law of the People's Republic of China*. Rigorous review and necessary export formalities are needed when exported.

Our company reserves the right to update the information of our products.

## Safety precautions

### Safety icons:



Read manual carefully and follow the directions  
务必在阅读使用说明书后，按其步骤操作！



Disconnect all power and wait 15 min. before  
servicing. May cause electric shock.  
通电中或断电15分钟内，请勿触摸端子，有触电危险！



Don't touch heatsink, May cause burn.  
请勿触摸散热片，有烫伤危险！



Contact currents up to 0.5mA, Before use must be  
reliable grounding.  
接触电流可达0.5mA，使用前必须可靠接地！

The safety icons are on the side cover of the servo drive. Please follow these instructions when operation.

### Following safety precautions should be paid attention to before any installation, configuration, operation, maintenance and inspection:

- Check whether the AC power supply is the same as the rated voltage of the servo drive, otherwise fire, hurt, damage to the drive may occur.
- Do not connect the input power cables to the output terminals, otherwise damage to the drive may occur.
- Do not carry out any insulation and voltage withstand test to the drive, and do not test the control circuit of the drive by megameter.
- Connect the drive and motor as correct phase sequence, otherwise drive fault or damage may occur.
- De-couple the motor load and run the motor independently before operation to avoid accidents.
- Please ensure the drive can be disconnected from the power supply by E-switch before any operation.
- Set the corresponding parameters before operation, otherwise the drive may run abnormally or beyond the expectation because of the load.
- Only qualified electrical engineers can carry out the wiring, otherwise electric shock or fire may occur.
- Do not touch the conductive parts and components directly. Do not connect the output cables

with the enclosure and avoid any short connection, otherwise electric shock and danger may occur.

- Rewire the drive after 15 minutes when disconnecting the power supply, otherwise electric shock may occur.
- Do ground with proper techniques because the touch current may be 0.5mA, otherwise electric shock may occur.
- Do not touch the heat sink and external braking resistor during operation, otherwise burning may occur for the hot sides.
- Do install the overcurrent protector, leakage current protector and emergency device and ensure the normal usage after wiring, otherwise electric shock, hurt and fire may occur.
- The leakage current may exceed 3.5mA during the drive running. Do ground with proper techniques and ensure the grounding resistor is less than 10Ω. The conductivity of PE earth conductor is the same as the phase conductor (with the same cross area).
- There is heavy metal in the components of the drive and the drive is industrial waste after scrapping.



## Contents

Preface .....	1
Safety precautions .....	2
Contents .....	1
Product overview	1
1.1 Servo drive .....	1
1.2 Servo motor .....	7
1.3 Cables .....	9
1.4 Braking resistors .....	12
Installation	2
2.1 Drive dimension .....	13
2.2 Drive installation .....	14
2.3 Motor dimension .....	16
2.4 Motor installation .....	17
Wiring	3
3.1 System wiring .....	18
3.2 Wiring of the main circuit .....	20
3.3 Wiring of power cables for the motors .....	22
3.4 I/O-CN1 terminals .....	22
3.5 Wiring of encoder-CN2 terminals .....	23
3.6 Wiring of 485/CAN-CN3 terminals .....	25
3.7 Wiring of USB-CN4 terminals .....	25
3.8 Wiring of STO/Full closed loop-CN5 terminals .....	26
3.9 Wiring of PROFIBUS-DP terminals .....	27
Control mode applications	4
4.1 Standard wiring of the position mode .....	28
4.2 Standard wiring of the speed mode .....	29
4.3 Standard wiring of the torque mode .....	30
4.4 CN1 functions .....	30
4.5 CN1 wiring .....	43
Running and operation	5
5.1 Running .....	50
5.2 Display and operation .....	61
Detailed parameter description	6
	68

6.1 Basic parameters (P0 group parameters) .....	68
6.2 Autoturning control parameters (P1) .....	100
6.3 Motor control parameters (P2) .....	110
6.4 I/O management parameters (P3).....	125
6.5 Extension and application (P4) .....	145
6.6 Bit control and returning (P5 and P6) .....	170
6.7 Factory parameters (P8,P9 and P10).....	195
6.8 State monitoring .....	195
Commissioning	7 .....
7.1 Operation instruction of inertia identification .....	214
7.2 General method for parameters adjusting .....	214
7.3 Suppression of mechanical resonance .....	221
7.4 Gain switching function .....	222
Communication	8 .....
8.1 Instruction .....	226
8.2 RS485 communication protocol .....	226
8.3 CANopen communication protocol.....	231
8.4 PROFIBUS-DP communication protocol.....	237
8.5 PC software.....	242
Fault process	9.....
9.1 Meanings of the fault alarm codes and countermeasures .....	247
9.2 CANopen communication fault code and countermeasures .....	255
9.3 PROFIBUS-DP communication fault code and countermeasures.....	257
Appendix	10 .....
10.1 List of function parameters .....	258
10.2 State monitoring .....	273
10.3 General monitoring parameters.....	276
10.4 Fault code .....	277
10.5 Record table of parameter setting .....	281

# Product overview

1

## 1.1 Servo drive

### 1.1.1 Instruction

DA200 series servo drives (200W~5.5kW)			
Specifications		Description	
Power supply	220V system input voltage	1P/3P	AC220V(-15%)~240V(+10%) 47Hz~63Hz
	400V system input voltage	3P	AC380V(-15%)~440V(+10%) 47Hz~63Hz
Interface	Control signal	Input	10 inputs (the function can be configured by some parameters)
		Output	6 outputs (the function can be configured by some parameters)
	Analog value	Input	3 inputs (1 16bitA/D input , 2 12bitA/D inputs)..
		Output	2 outputs (analog monitoring output)
	Pulse signal	Input	2 inputs (open collector input/differential input)
		Output	6 outputs (3 differential outputs, 3 open collector outputs)
	communication	USB	1:1 communication upper PC software (standard)
		RS485	1:n communication (standard)
		CANopen	1:n communication (standard)
		Profibus-DP	1:n communication (standard)
	Safety terminals	EtherCAT	1:n communication (standard)
STO		Safe torque off (to the latest European safety standards) (optional)	
Control mode	1 Position control; 2 Speed control; 3 Torque control; 4 Position/Speed mode switching; 5 Speed/Torque mode switching; 6 Position/Torque mode switching; 7 Full closed loop control; 8 CANopen mode; 9 EtherCAT mode; 10 MotionNet mode		
Functions	Position control	Control input	1 Retention pulse clear; 2 Command pulse input disabled; 3 Command switch frequency doubling; 4 Vibration control switching
		Control output	Output after positioning finished
	Pulse input	Max. pulse input frequency	1 optical coupling: differential input 4Mpps, open collector input 200Kpps;
		Pulse input mode	1 Positive/Negative direction; 2 A phase/B phase; 3 Command pulse/Command direction

DA200 series servo drives (200W~5.5kW)					
Specifications			Description		
			Electric gear	1/10000~1000 times	
			Filter	1 Command smoothing filter; 2 FIR filter	
		Analog input	Torque command input	Can be independently arrange clockwise/ counterclockwise torque limit	
		Vibration control	Control the forward and whole machine vibration of 5~200Hz		
		Pulse output	1 Arbitrary frequency division settings under the encoder resolution 2 B phase reverse		
	Speed control	Control input	1 Internal command speed 1; 2 Internal command speed 2; 3 Internal command speed 3; 4 Zero speed clamp		
			Control output	Speed arrival	
		Analog input	Speed command input	Speed command input of the analog voltage DC±10V setting	
			Torque limit input	Can be independently arrange clockwise/ counterclockwise torque limit	
		Internal speed commands	8 step speed can be switched according to the external control input		
ACC/DEC adjustment of the speed command		ACC/DEC time setting and S curve setting			
Zero speed clamp		In the speed mode, it can set the operation mode as the speed mode and position mode			
Speed command filter	A delay filter of analog input speed command				
Speed command zero drift control	Zero drift control to the outside interference Precision 0.3mV				

DA200 series servo drives (200W~5.5kW)				
Specifications		Description		
Torque control	Control input	Zero speed clamp input		
	Control output	Speed arrival		
	Analog input	Torque command input	Analog torque command input, gain and polarity setting to the analog voltage Precision 4.88mV	
		Speed limit input	Analog speed limit	
	Speed limit	Set the speed limit by parameters		
	Torque command filter	A delay filter of analog input torque command		
	Torque command Zero drift control	Zero drift control to the outside interference Precision 4.88mV		
	Internal position plan	Plan points	16-bit internal position planning, the positioning can be controlled through the communication	
		Route setting	1 Position; 2 Speed; 3 ACC time; 4 DEC time; 5 Stop timer; 6 Various state output; 7 Operational mode	
		Origin returning	1 LS signal; 2 Z phase signal; 3 LS signal+Z phase signal; 4 Torque limit signal	
Protection	Hardware protection	Overvoltage, undervoltage, overcurrent, overspeed, overload, braking resistor overload, overheat, encoder fault and so on		
	Software protection	Memory and initialization fault, the I/O distribution abnormalities and large position deviation		
	Protection and fault record	1. 10 kinds of fault can be recorded 2. Can record the current key parameters when fault occurs		
Environment	Temperature	Operation temperature	0~45℃	
		Storage temperature	-20~80℃(no freezing)	
	Humidity	Operation/storage: ≤90%RH (no condensation)		
	IP degree	IP20		
	Altitude	Below 1000m		

DA200 series servo drives (200W~5.5kW)		
Specifications		Description
Vibration	≤5.88m/s <sup>2</sup> , 10~60Hz(Not allowed to work at the resonance point)	

### 1.1.2 External appearance of the drive

- ◆ Standard

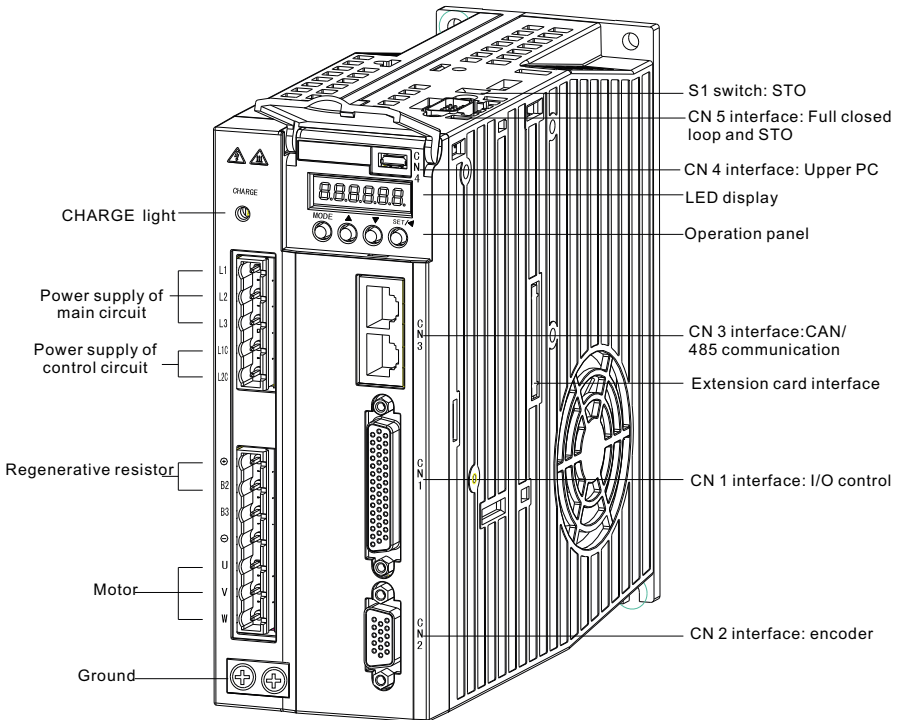

◆ With extension cards

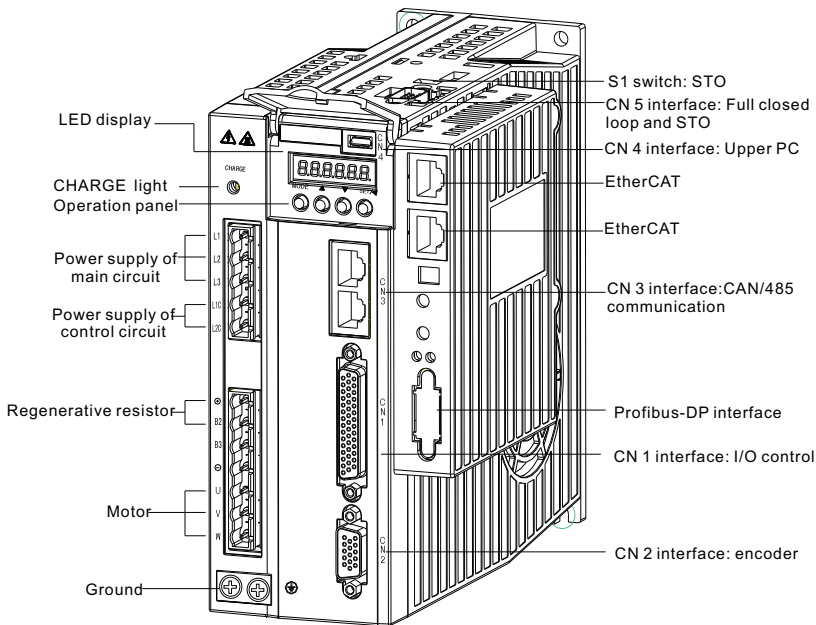

1.1.3 Naming of the drive

**SV-DA200 -0R4 -2 -S 5**  
**A B C D E F**



Key	Description
A	SV: Servo series products
B	DA200: Product series
C	Power ratings:
	R05: 50W    0R4: 400W    0R7: 750W    1R0: 1.0kW    2R0: 2.0kW 5R5: 5.5kW    7R5: 7.5kW    011: 11kW    015: 15kW
D	Input voltage
	2: 220VAC; 4: 400VAC
E	Machine type
	E: Pulse; S: Standard; C: CANopen bus; P: PROFIBUS-DP bus; N: EtherCAT bus; M: MotionNet bus; T: ECAM
F	Available encoder type

Key	Description		
	Null	2500-wire standard incremental	
		2500-wire multiplexed data line incremental	
		17-bit single circle absolute value	
		17-bit multiple circle absolute value	
	5	20-bit single circle absolute value	
		20-bit multiple circle absolute value	
	7	12-bit rotary transformer	
	8	16-bit rotary transformer	

Difference between machine types:

Code	Type	Pulse input	16bit analog	Full closed-loop	STO	RS485	CAN open	PROFIBUS-DP	EtherCAT	Motion Net	ECAM
E	Pulse	√	x	√	x	√	x	x	x	x	x
S	Standard	√	√	√	√	√	x	x	x	x	x
C	CAN	x	x	x	x	x	√	x	x	x	x
P	PROFIBUS-DP	x	x	x	x	x	x	√	x	x	x
N	EtherCAT	x	x	x	x	x	x	x	√	x	x
M	MotionNet	x	x	√	x	√	x	x	x	√	x
T	ECAM	√	x	√	x	√	x	x	x	x	√

### 1.1.4 Name plate of the drive

<b>伺服驱动器</b> SERVO DRIVES		<b>型号:</b> SV-DA200-OR4-2-S <b>MODEL:</b>	
<b>输入</b> INPUT	1P/3PH	AC220V (-15%)~240(+10%)	47~63Hz
<b>输出</b> OUTPUT	3PH	AC0~400V	0~400Hz 2.8A 400W
S/N:		 <b>Made in China</b>	
 <b>上海英威腾工业技术有限公司</b> INVVT INDUSTRIAL TECHNOLOGY (SHANGHAI) CO., LTD.			



### 1.1.5 Power ratings and volumes

Model	Input	Output		Volume
	Voltage(V)	Power (kW)	Rated current(A)	
SV-DA200-0R2-2	Single/Three phase 220	0.2	1.8	A
SV-DA200-0R4-2	Single/Three phase 220	0.4	2.8	A
SV-DA200-0R7-2	Single/Three phase 220	0.75	4.5	B
SV-DA200-1R0-2	Single/Three phase 220	1.0	5	B
SV-DA200-1R5-2	Three phase 220	1.5	7.6	B
SV-DA200-2R0-2	Three phase 220	2.0	10	D
SV-DA200-3R0-2	Three phase 220	3.0	13	D
SV-DA200-4R4-2	Three phase 220	4.4	16.5	D
SV-DA200-1R0-4	Three phase 400	1.0	3.5	B
SV-DA200-1R5-4	Three phase 400	1.5	4.5	B
SV-DA200-2R0-4	Three phase 400	2.0	6.5	C
SV-DA200-3R0-4	Three phase 400	3.0	8.5	C
SV-DA200-4R4-4	Three phase 400	4.4	12	D
SV-DA200-5R5-4	Three phase 400	5.5	16	D

## 1.2 Servo motor

### 1.2.1 Name plate of the motor

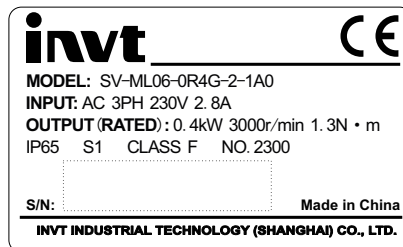

**Note:** "2300" on the name plate is the motor model, and please input the number into P0.00 correctly.

1.2.2 Naming of the motor

**SV- ML 06-0R4 G-2-4 A 0**

① ② ③ ④ ⑤ ⑥ ⑦ ⑧ ⑨

Key	No.	Description	Example
Product	①	Product	SV-Servo system
Series name	②	Inertia degree	ML- general servo motor of small inertia MM- general servo motor of medium inertia MH- general servo motor of big inertia
	③	Base	06-60mm 08-80mm 11-110mm 13-130mm 18-180mm
Power + Load/Speed	④	Rated power	R05-50W 0R4-400W 0R7-750W 1R0-1.0kW 1R5-1.5kW 3R0-3.0kW 5R5-5.5kW 7R5-7.50kW 011-11kW 015-15kW
	⑤	Rated speed	A-1000rpm B-1500rpm E-2000rpm F-2500rpm G-3000rpm
Voltage degree	⑥	Voltage degree	2-220VAC 4-380VAC
Lot No.	⑦	Encoder type	1-2500-wire standard incremental 2-2500-wire multiplexed data line incremental 3-17-bit single circle absolute value 4-17-bit multiple circle absolute value 5-20-bit single circle absolute value 6-20-bit multiple circle absolute value

Key	No.	Description	Example
			7-12-bit rotary transformer 8-16-bit rotary transformer
	⑧	Axis connection	A- Solid with screw hole and key (standard) B- Solid axis
	⑨	Optional parts	0- With oil seal and no breaker 1- No breaker and oil seal 2- With oil seal and breaker 3- With breaker and no oil seal

### 1.3 Cables

#### 1.3.1 Name plate of cables

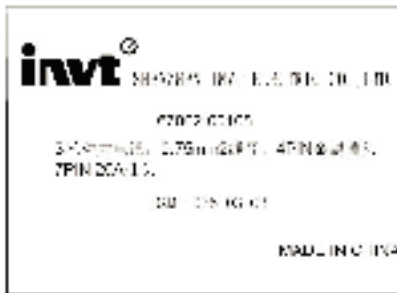

#### 1.3.2 Naming of the power cables

**DA ML-075-03-ABF**  
 ①    ②    ③    ④    ⑤ ⑥ ⑦

Key	No.	Description	Example
Product	①	Manufacturer	
Power cable	②	Power cable	ML- Power cable
Coil diameter	③	Coil diameter	075-0.75mm <sup>2</sup> 100-1.0mm <sup>2</sup> 150-1.5mm <sup>2</sup> 250-2.5mm <sup>2</sup>
Length	④	Cable length	03-3 meters 05-5 meters 10-10 meters 15-15 meters

Key	No.	Description	Example
Pin for motors	⑤	Pin for motors	A-4PIN plastic pin B-4PIN general aviation pin YD28 C-4PIN metal pin
Pin for drives	⑥	Pin for drives	B- European 7PIN 20A pin W- No pin
Cable materials	⑦	Cable materials	F- Flexible tray cables Null- Standard cables

### 1.3.3 Naming of the power cables

DA ML - A B  
 ①      ②      ⑤      ⑥

Key	No.	Description	Example
Product	①	Manufacturer	
Power cable	②	Power cable	ML- Power cable
Pin for motors	⑤	Pin for motors	A-4PIN plastic pin B-4PIN general aviation pin YD28 C-4PIN metal pin
Pin for drives	⑥	Pin for drives	B- European 7PIN 20A pin W- No pin

### 1.3.4 Naming of the encoder cables

DB EL - 15 - 03 - A F  
 ①      ②      ③      ④      ⑤      ⑥

Key	No.	Description	Example
Product	①	Manufacturer	
Encoder cable	②	Encoder cable	EL- Encoder cable
Cable core	③	Core	06-6-core cable 09-9-core cable 15-15-core cable
Length	④	Cable length	03-3 meters 05-5 meters 10-10 meters 30-30 meters
Pin for motors	⑤	Pin for motors	A-15PIN DB pin

Key	No.	Description	Example
			B-15PIN general aviation pin YD28 C-9PIN metal pin D-6PIN plastic pin
Cable materials	⑥	Cable materials	Null – standard cables D-with battery F-flexible tray cables H-with battery flexible cables

1.3.5 Naming of encoder cables fittings

DB EL-AA  
 ①      ②      ⑦      ⑤

Key	No.	Description	Example
Product	①	Manufacturer	
Encoder cable	②	Encoder cable	EL- Encoder cable
Pin for drives	⑦	Pin for drives	A-15PIN plastic pin
Pin for motors	⑤	Pin for motors	A-15PIN DB pin B-15PIN general aviation pin YD28 C-9PIN metal pin D-6PIN plastic pin

1.3.6 Naming of motor braking cables

BRKL-03-A  
 ①      ②      ③

Key	No.	Description	Example
Product	①	Product	BRKL-Motor braking cables
Length	②	Cable length	03-3 meters 05-5 meters 10-10 meters 30-30 meters
Pin for motors	③	Pin for motors	A-2PIN metal pin B-3PIN general aviation pin C-3PIN metal pin

## 1.4 Braking resistors

Model	Embedded braking resistor	Min. resistance of external braking resistors
SV-DA200-0R2-2	/	60Ω
SV-DA200-0R4-2	/	60Ω
SV-DA200-0R7-2	30Ω 60W	30Ω
SV-DA200-1R0-2	30Ω 60W	30Ω
SV-DA200-1R5-2	30Ω 60W	20Ω
SV-DA200-2R0-2	15Ω 120W	15Ω
SV-DA200-3R0-2	15Ω 120W	15Ω
SV-DA200-4R4-2	15Ω 120W	15Ω
SV-DA200-1R0-4	60Ω 60W	60Ω
SV-DA200-1R5-4	60Ω 60W	60Ω
SV-DA200-2R0-4	60Ω 60W	40Ω
SV-DA200-3R0-4	60Ω 60W	30Ω
SV-DA200-4R4-4	30Ω 120W	30Ω
SV-DA200-5R5-4	30Ω 120W	30Ω

# Installation

## 2

### 2.1 Drive dimension

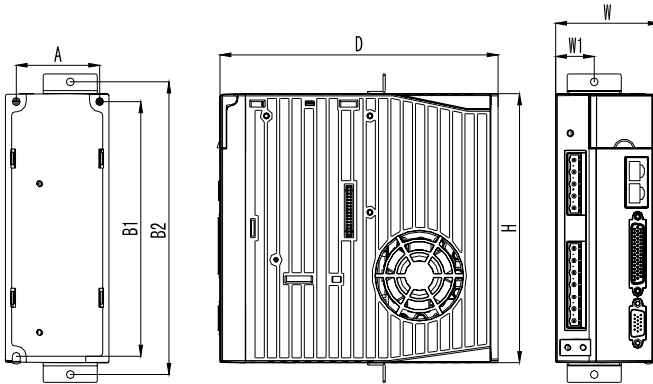

Model	External dimension			Installation dimension				Installation hole (mm)
	H (mm)	W (mm)	D (mm)	A (mm)	B1 (mm)	B2 (mm)	W1 (mm)	
SV-DA200-0R2-2	170	45	170	31	162	185	22.5	M4(φ5)
SV-DA200-0R4-2								
SV-DA200-0R7-2	170	67	180	54	162	185	25	M4(φ5)
SV-DA200-1R0-2								
SV-DA200-1R5-2								
SV-DA200-2R0-2	230	92	190	79	222	245	25	M4(φ5)
SV-DA200-3R0-2								
SV-DA200-4R4-2								
SV-DA200-1R0-4	170	67	180	54	162	185	25	M4(φ5)
SV-DA200-1R5-4								
SV-DA200-2R0-4	170	84	180	71	162	185	25	M4(φ5)
SV-DA200-3R0-4								
SV-DA200-4R4-4								
SV-DA200-5R5-4	230	92	190	79	222	245	25	M4(φ5)

## 2.2 Drive installation

### 2.2.1 Installation mode

1) Base installation (there is a  $\varnothing 5$  installation hole at the lower left corner and upper right corner of the rear board)

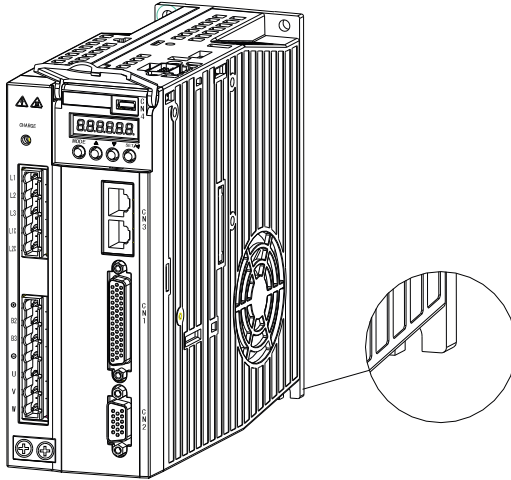

Figure 2-1 Installation hole

2) Bracket installation (the installation bracket is optional)

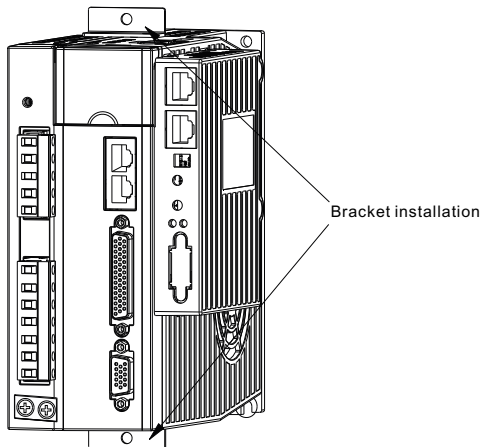

Figure 2-2 Installation bracket



### 2.2.2 Installation space and direction

Please install the servo drive vertically and keep enough installation space for good ventilation. It is necessary to install fans to ensure the temperature inside the control cabinet is lower than 45°C when needed.

1) Single drive

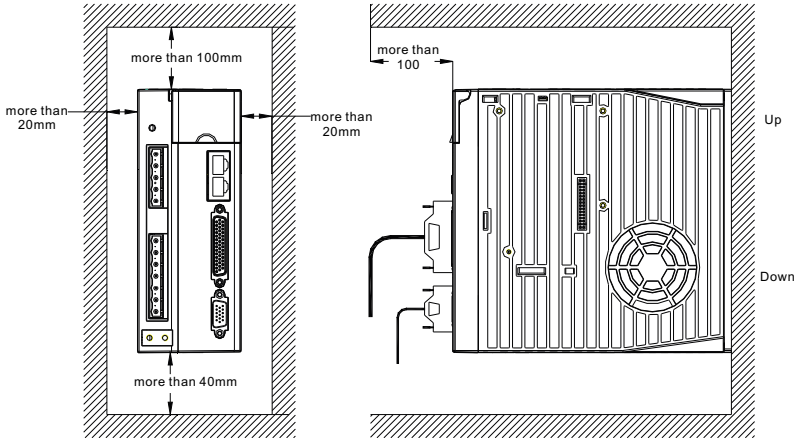

Figure 2-3 Installation space of single drive

2) Multiple drives

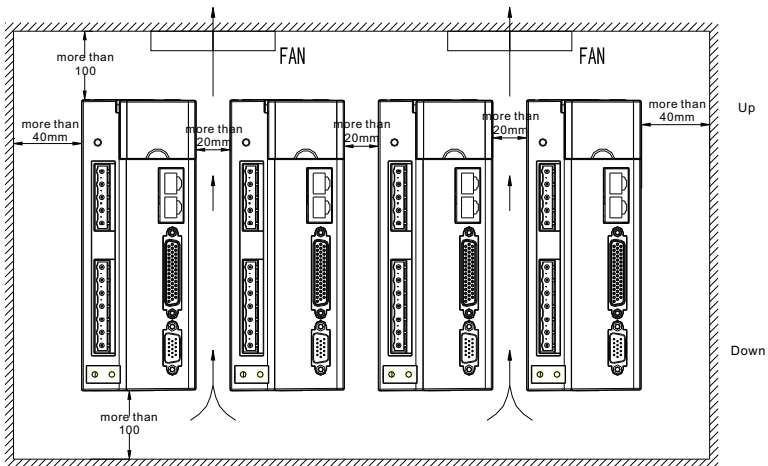
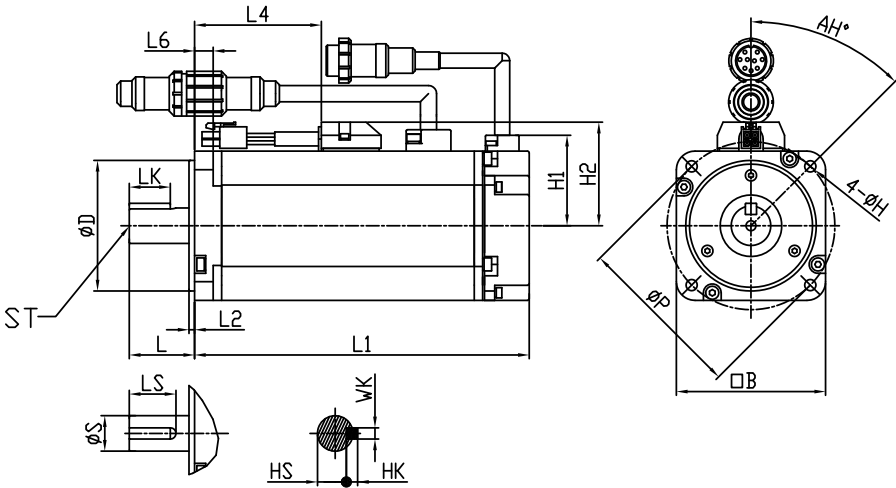

Figure 2-4 Installation space of multiple drives

### 2.3 Motor dimension

#### 2.3.1 Appearance and dimension of 60 and 80 bases



Model	Flange dimension							Axis and key dimension							L1	L4	H1	H2	ST
	D	L2	L6	P	H	AH	B	S	L	WK	HK	LK	HS	LS					
SV-ML06-0R2G-***1	50(h7)	3	6.5	70	5.5	45	60	14(h6)	30	5	5	22.5	11	25	106	41	38.5	45.5	M5 D10
SV-ML06-0R2G-***2															139.5				
SV-ML06-0R4G-***1															130				
SV-ML06-0R4G-***2															163.5				
SV-ML08-0R7G-***1	70(h7)	3	10	90	7	45	80	19(h6)	35	6	6	22	15.5	25	131	68	48.5	55.5	M5D10
SV-ML08-0R7G-***2															176				

### 2.3.2 Appearance and dimension of 130 and 180 bases

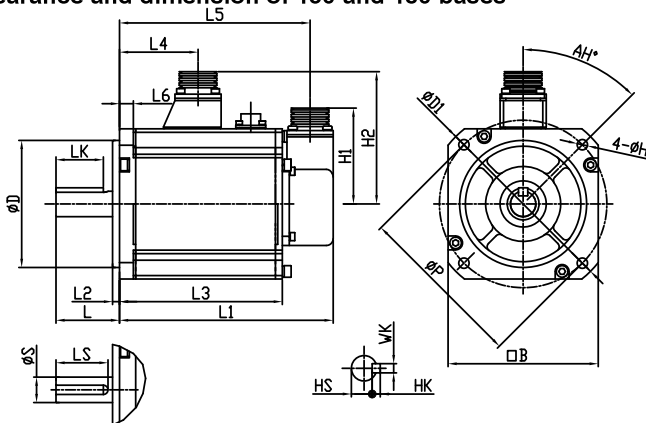

Model	Flange dimension								Axis and key dimension								L1	L3	L4	L5	H1	H2
	D	L2	L6	P	H	AH	D1	B	S	L	WK	HK	LK	HS	LS							
SV-MM13-1R0E-**-**0	110(h7)	6	12	145	9	45	165	130	22(h6)	55	8	7	41	18	45	143	99	68	123	83	114.5	
SV-MM13-1R0E-**-**2																185	141	68	165			
SV-MM13-1R5E-**-**0																159	115	84	139			
SV-MM13-1R5E-**-**2																201	157	84	181			
SV-MM13-2R0E-**-**0																175	131	100	155			
SV-MM13-2R0E-**-**2																217	173	100	197			
SV-MM13-3R0E-**-**0																207	163	132	187			
SV-MM13-3R0E-**-**2																249	205	132	229			

### 2.4 Motor installation

- ◆ Do not pull the motor leads or output shaft during fetching and moving;
- ◆ Do not beat or hammer during the motor configuration to avoid damage to the encoder or shafts;
- ◆ Please wipe the slushing oil on the motor shaft before using.

**Note:** Please ensure the motor code of the name plate is the same as P0.00 before using for the best performance. The motor code is shown as below:

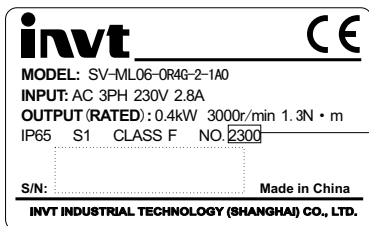

the last 4 figures are the motor code

# Wiring

## 3

### 3.1 System wiring

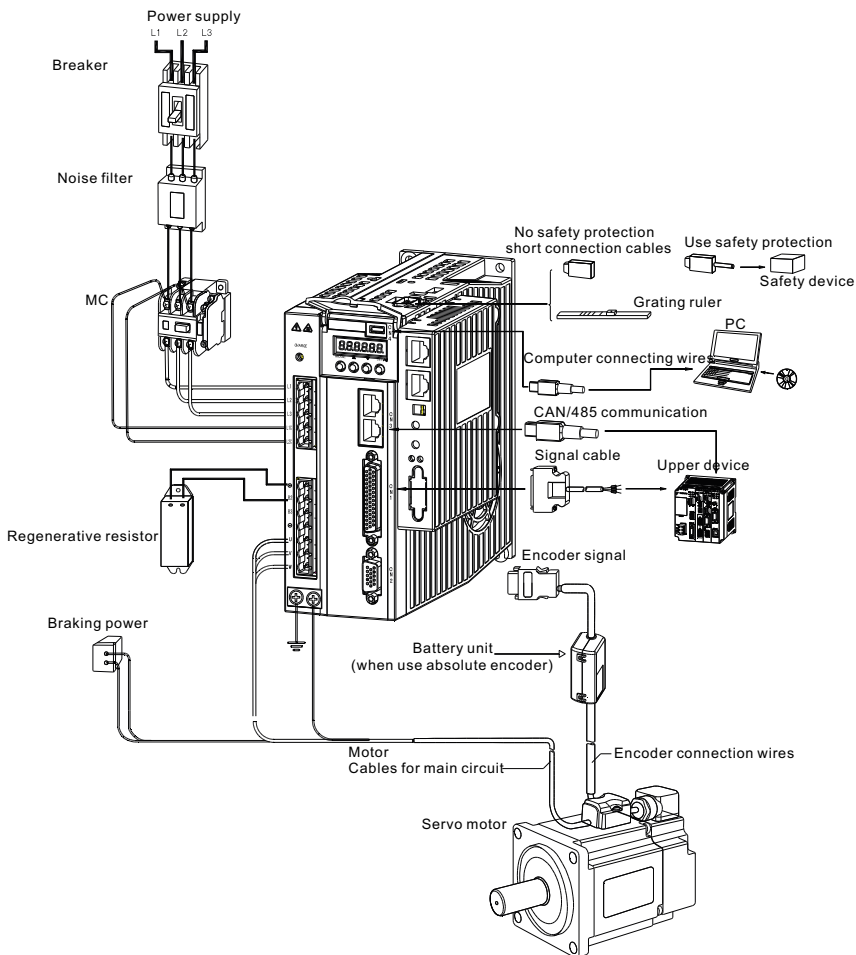

Figure 3-1 Wiring of the servo drive and external devices

- ◆ Check to ensure the input power supply indicated on the name plate is the same as the

grid before connecting the power supply of the drive.

- ◆ The electromagnetic contactor is used to switch on/off the power supply of the main circuit of the servo drive. Do not use it to start/stop the servo drive.
- ◆ In the figure above, the built-in regenerative braking resistor is used as default. If an external regenerative braking resistor is used, please refer to relevant wiring diagram. The regenerative braking resistor must be mounted on non-flammable materials, such as metal.

### 3.1.1 Coil diameter

Model	Specification
SV-DA200-0R2-2	0.75mm <sup>2</sup> /18AWG
SV-DA200-0R4-2	
SV-DA200-0R7-2	
SV-DA200-1R0-2	1.5mm <sup>2</sup> /15AWG
SV-DA200-1R5-2	
SV-DA200-2R0-2	2.5 mm <sup>2</sup> /13AWG
SV-DA200-3R0-2	
SV-DA200-4R4-2	
SV-DA200-1R0-4	1.5mm <sup>2</sup> /15AWG
SV-DA200-1R5-4	
SV-DA200-2R0-4	
SV-DA200-3R0-4	
SV-DA200-4R4-4	2.5 mm <sup>2</sup> /13AWG
SV-DA200-5R5-4	

### 3.1.2 EMI filter

Model	EMI filter
SV-DA200-0R2-2	FLT-P04016L-B
SV-DA200-0R4-2	
SV-DA200-0R7-2	
SV-DA200-1R0-2	
SV-DA200-1R5-2	
SV-DA200-2R0-2	
SV-DA200-3R0-2	
SV-DA200-4R4-2	
SV-DA200-1R0-4	
SV-DA200-1R5-4	

Model	EMI filter
SV-DA200-2R0-4	
SV-DA200-3R0-4	
SV-DA200-4R4-4	
SV-DA200-5R5-4	

**Note:** The EMI filter models in the table means the filter product models of our company.

## 3.2 Wiring of the main circuit

### 3.2.1 Wiring of single phase 220V

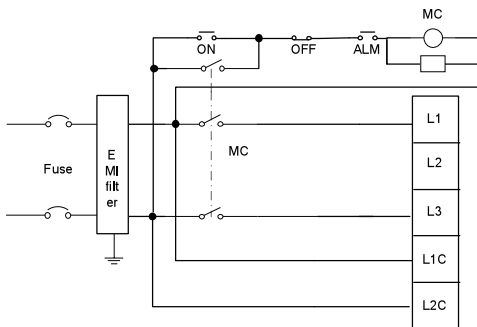

The user is required to make this emergency stop protection circuit.  
Fit surge absorbing devices on both ends of the electromagnetic contactor winding.

The input voltage range of main circuit and control circuit is AC 220V(-15%)~240(+10%)  
Please connect terminal R with terminal T.

Note: Please use 3-phase input power for the drive of 1.5kW and above.

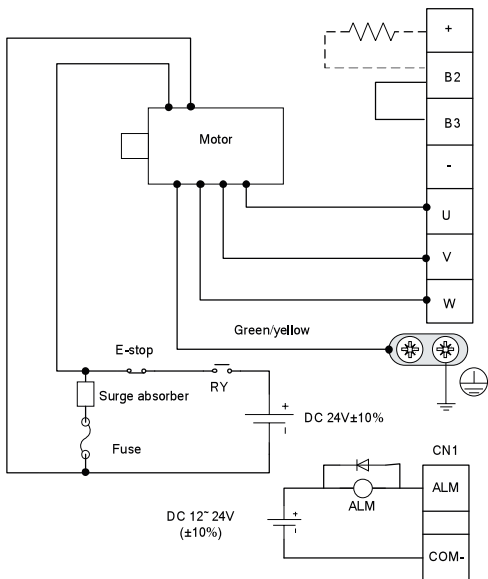

Connect the output U, V, and W of the drive to the servo motor correctly according to the phase sequence of the motor cable of the servo motor. Wrong phase sequence will cause drive fault.

Do not disconnect the short circuit wire between B2 and B3 unless an external regenerative braking resistor is used. When an external regenerative braking resistor is used, disconnect the short circuit wire between B2 and B3, and connect it according to the dashed in the figure.

Be sure to ground the servo drive to avoid accident of electrical shock.

The electromagnetic brake uses 24V power supply which should be provided by the user. Moreover, it must be isolated with the 12-24V power supply which is used for the control signal.

Pay attention to the connection of the freewheeling diode. Reversed polarity may damage the drive.

### 3.2.2 Wiring of three phase 220V/400V

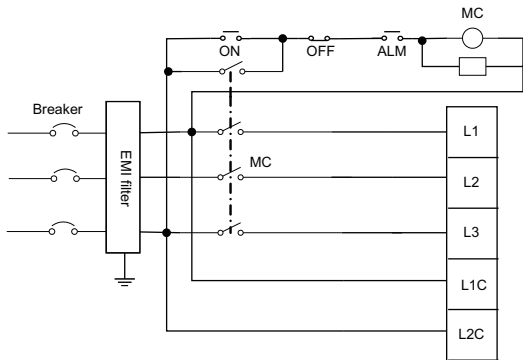

The user is required to make this emergency stop protection circuit.  
Fit surge absorbing devices on both ends of the electromagnetic contactor winding.

The input voltage range of 220V system: AC 220V (-15%)~240(+10%)

The input voltage range of 400V system: AC 380V (-15%)~440(+10%)

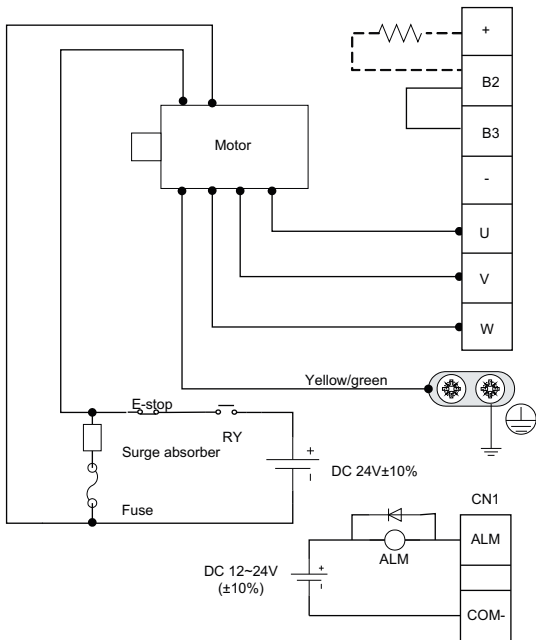

Correctly connect to output U, V, and W of the drive according to the phase sequence of the motor cable of the servo motor. Wrong phase sequence will cause drive fault.  
Do not disconnect the short circuit wire between B2 and B3 unless an external regenerative braking resistor is used.  
When an external regenerative braking resistor is used, disconnect the short circuit wire between B2 and B3, and connect it according to the dashed in the figure.

Be sure to ground the servo drive to avoid accident of electrical shock.

The electromagnetic brake uses 24V power supply which should be provided by the user. Moreover, it must be isolated with the 12-24V power supply which is used for the control signal.  
Pay attention to the connection method of the freewheeling diode. Reversed polarity may damage the drive.

### 3.3 Wiring of power cables for the motors

#### 3.3.1 Power cable of 60 and 80 bases

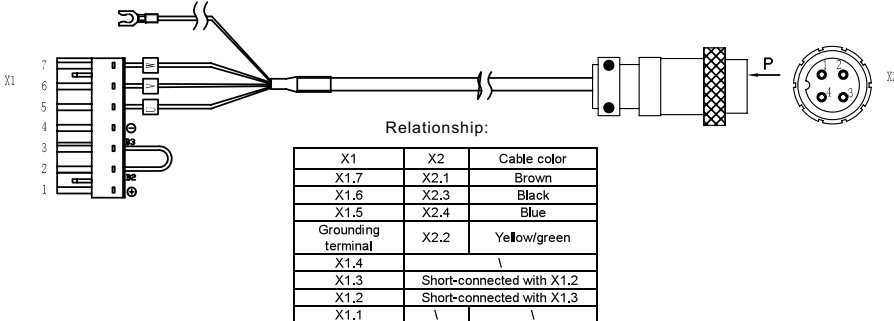

#### 3.3.2 Power cable of 130 and 180 bases

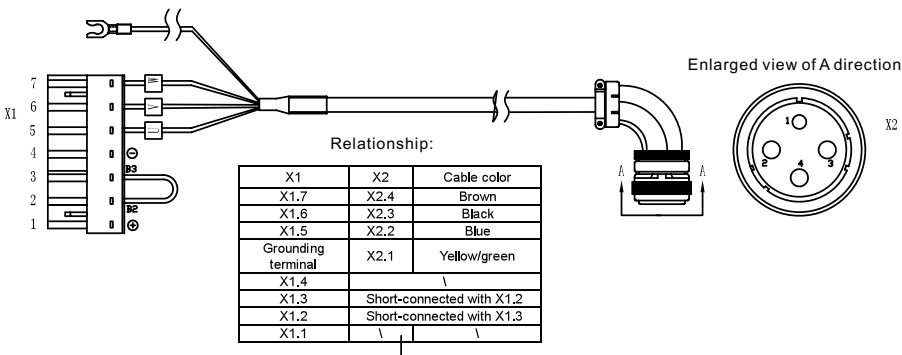

### 3.4 I/O-CN1 terminals

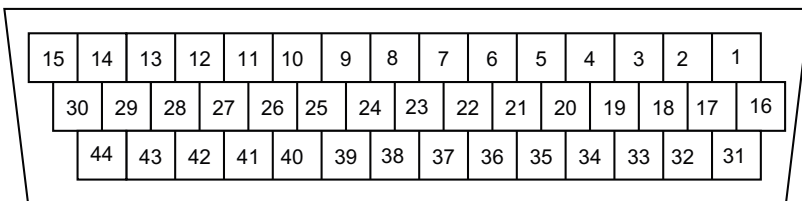

CN1 pin arrangement

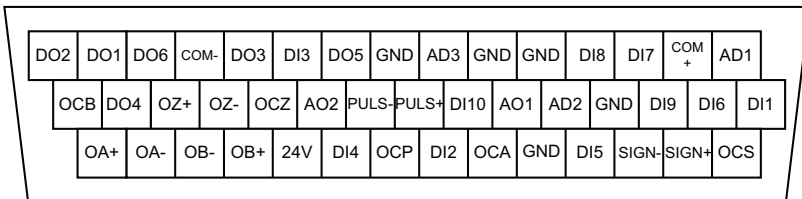

CN1 signal arrangement

Remark: Please refer to chapter 4 for the terminals function and applications.



### 3.5 Wiring of encoder-CN2 terminals

#### 3.5.1 CN2 terminals

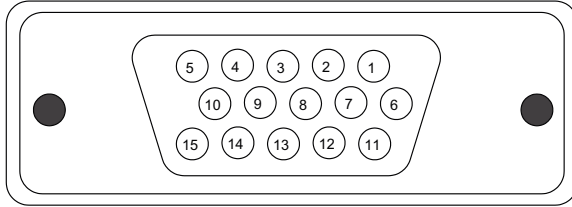

CN2 interface			
Pin	Name	Function	Remark
1	V+ / SD+	Parallel encoder V+/Serial encoder data+	Different encoders use different cables
2	W+	Signal of parallel encoder W+	
3	A+	Signal of parallel encoder A+	
4	A-	Signal of parallel encoder A-	
5	5V	Encoder power supply	
6	U+	Signal of parallel encoder U+	
7	V- /SD-	Parallel encoder V-/Serial encoder data-	
8	W-	Signal of parallel encoder W-	
9	B-	Signal of parallel encoder B-	
10	B+	Signal of parallel encoder B+	
11	U-	Signal of parallel encoder U-	
12	GND	Power earth	
13	Z-	Signal of parallel encoder Z-	
14	Z+	Signal of parallel encoder Z+	
15	/		

#### 3.5.2 Communication encoder cables of 60 and 80 bases

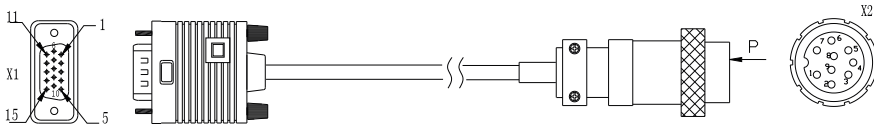

Relationship:

Signal	X1	X2	Cable color	Cable structure
SD+	X1.1	X2.1	Black	Twist pair
SD-	X1.7	X2.2	Black/White	
5V	X1.5	X2.3	Purple	Twist pair
GND	X1.12	X2.4	Purple/White	
PE	Enclosure	Enclosure	Knitting	

### 3.5.3 Multiplexed data line encoder cables of 60 and 80 bases

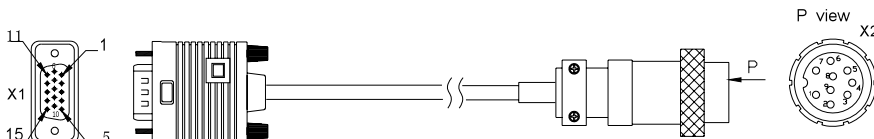

Relationship:

Signal	X1	X2	Cable color	Cable structure
A+	X1.3	X2.1	Red	Twist pair
A-	X1.4	X2.2	Red/White	
B+	X1.10	X2.3	Blue/White	Twist pair
B-	X1.9	X2.4	Blue	
Z+	X1.14	X2.5	Green/White	Twist pair
Z-	X1.13	X2.6	Green	
5V	X1.5	X2.7	Purple	Twist pair
GND	X1.12	X2.8	Purple/White	
PE	Enclosure	Enclosure	Knitting	

### 3.5.4 Encoder cables of 60 and 80 standard bases

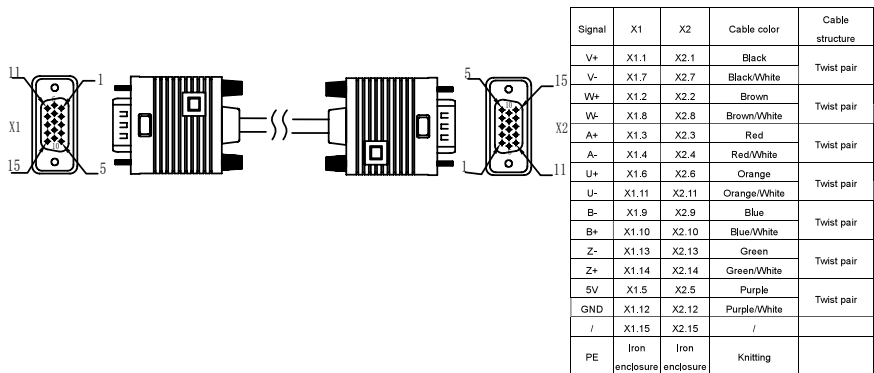

Signal	X1	X2	Cable color	Cable structure
V+	X1.1	X2.1	Black	Twist pair
V-	X1.7	X2.7	Black/White	
W+	X1.2	X2.2	Brown	Twist pair
W-	X1.8	X2.8	Brown/White	
A+	X1.3	X2.3	Red	Twist pair
A-	X1.4	X2.4	Red/White	
U+	X1.6	X2.6	Orange	Twist pair
U-	X1.11	X2.11	Orange/White	
B-	X1.9	X2.9	Blue	Twist pair
B+	X1.10	X2.10	Blue/White	
Z-	X1.13	X2.13	Green	Twist pair
Z+	X1.14	X2.14	Green/White	
5V	X1.5	X2.5	Purple	Twist pair
GND	X1.12	X2.12	Purple/White	
/	X1.15	X2.15	/	
PE	Iron enclosure	Iron enclosure	Knitting	

### 3.5.5 Communication encoder cables of 130 and 180 bases

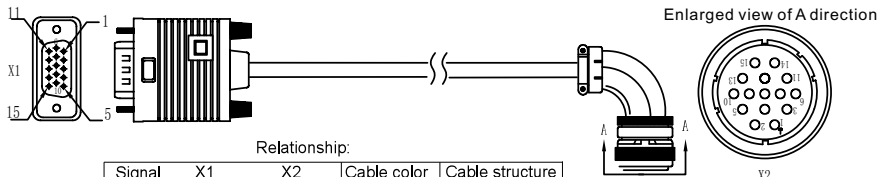

Relationship:

Signal	X1	X2	Cable color	Cable structure
SD+	X1.1	X2.2	Black	Twist pair
SD-	X1.7	X2.3	Black/White	
5V	X1.5	X2.4	Purple	Twist pair
GND	X1.12	X2.5	Purple/White	
PE	Enclosure	Enclosure	Knitting	

### 3.5.6 Encoder cables of 130 and 180 standard bases

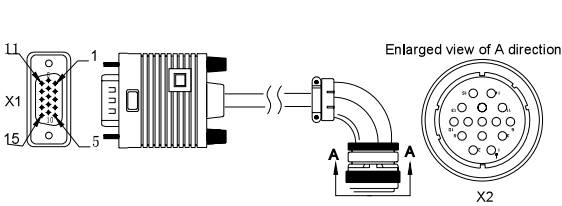

Relationship

Signal	X1	X2	Cable color	Cable structure
A+	X1.3	X2.7	Red	Twist pair
A-	X1.4	X2.4	Red/White	
B+	X1.10	X2.5	Blue/White	Twist pair
B-	X1.9	X2.8	Blue	
Z+	X1.14	X2.6	Green/White	Twist pair
Z-	X1.13	X2.9	Green	
U+	X1.6	X2.10	Orange	Twist pair
U-	X1.11	X2.13	Orange/White	
V+	X1.1	X2.11	Black	Twist pair
V-	X1.7	X2.14	Black/White	
W+	X1.2	X2.12	Brown	Twist pair
W-	X1.8	X2.15	Brown/White	
5V	X1.5	X2.2	Purple	Twist pair
GND	X1.12	X2.3	Purple/White	
PE	Enclosure	X2.1	Knitting	

### 3.6 Wiring of 485/CAN-CN3 terminals

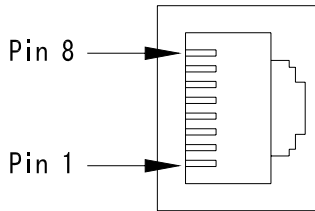

CN3 interface			
Pin	Name	Function	Remark
1	5V	Power supply	485 and CAN use the same interface and each terminal has two pins for multiple networking.
2	GND	Power ground	
3	/		
4	RS485+	RS485 data +	
5	RS485-	RS485 data -	
6	/		
7	CAN_L	CAN data -	
8	CAN_H	CAN data +	

### 3.7 Wiring of USB-CN4 terminals

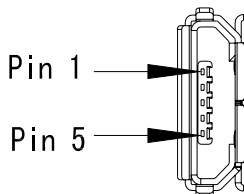

CN4 USB interface			
Pin	Name	Functions	Remark
1	VBUS	External power supply +5V	The standard cable for USB micro to USB-A conversion is available.
2	D-	Data -	
3	D+	Data +	
4	-	Not used	
5	GND	Signal ground	

### 3.8 Wiring of STO/Full closed loop-CN5 terminals

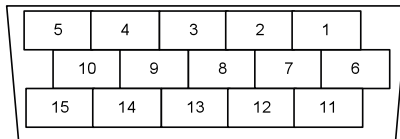
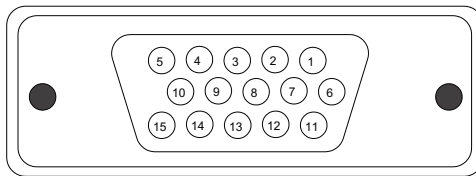

CN5 pin arrangement

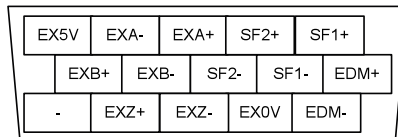

CN5 signal arrangement

CN5 interface			
Pin	Name	Function	Remark
1	SF1+	Safety input 1+	Only receive the parallel signal of grating ruler
2	SF2+	Safety input 2+	
3	EXA+	Raster A+	
4	EXA-	Raster A-	
5	EX5V	Power supply +5V	
6	EDM+	Security monitoring output +	
7	SF1-	Safety input 1-	
8	SF2-	Safety input 2-	
9	EXB-	Raster B-	

CN5 interface			
Pin	Name	Function	Remark
10	EXB+	Raster B+	
11	EDM-	Security monitoring output -	
12	EX0V	Power earth, be connected with internal GND	
13	EXZ-	Raster Z-	
14	EXZ+	Raster Z+	
15	-	Not used	

### 3.9 Wiring of PROFIBUS-DP terminals

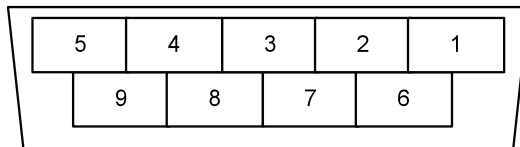

DP pin arrangement

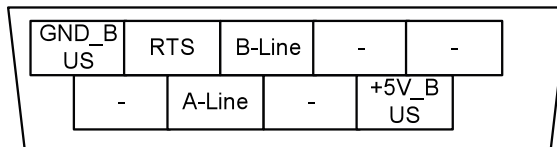

DP signal arrangement



DP interface			
Pin	Name	Function	Remark
1	-	Not used	DP standard terminals and pin connection
2	-	Not used	
3	B-Line	Data +	
4	RTS	Request sending	
5	GND_BUS	Isolator	
6	+5V_BUS	Isolation of 5V power supply	
7	-	Not used	
8	A-Line	Data -	
9	-	Not used	

# Control mode applications

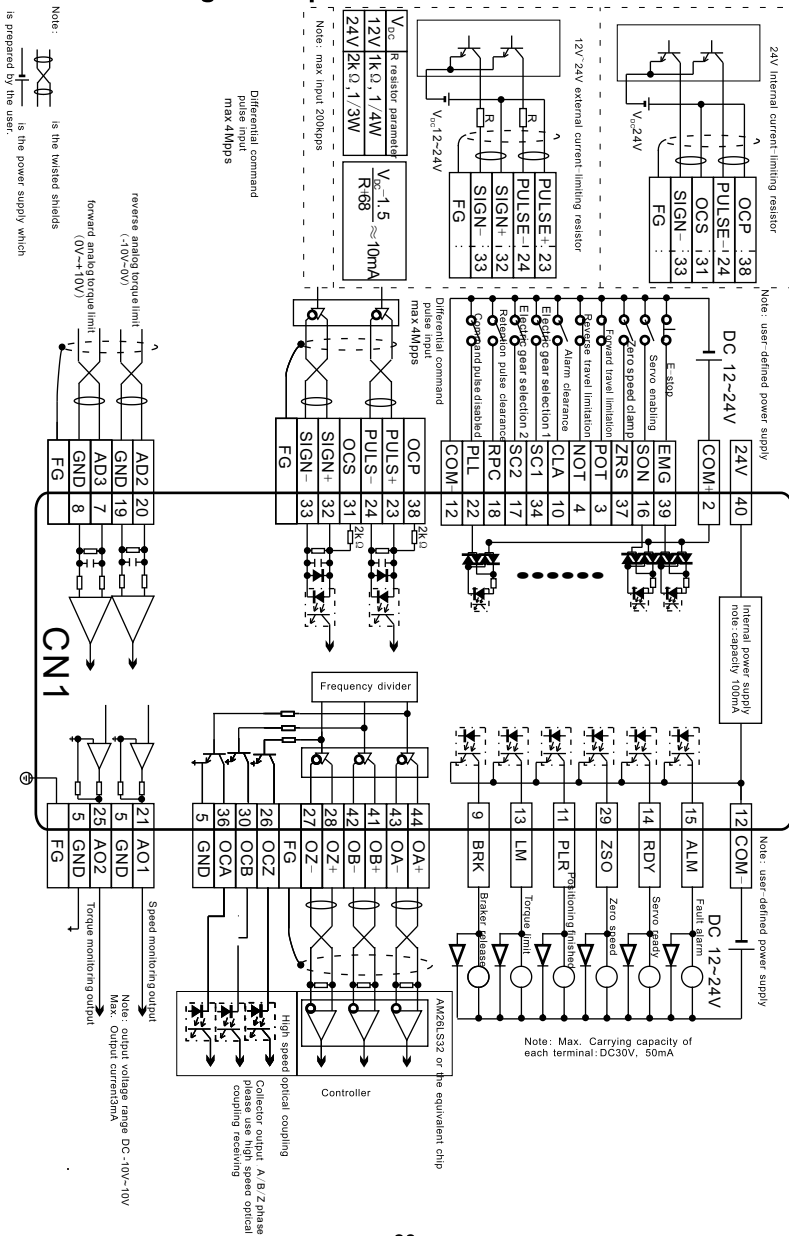
## 4.1 Standard wiring of the position mode



## 4.2 Standard wiring of the speed mode

Note:  
 is the twisted shields  
 is the power supply which

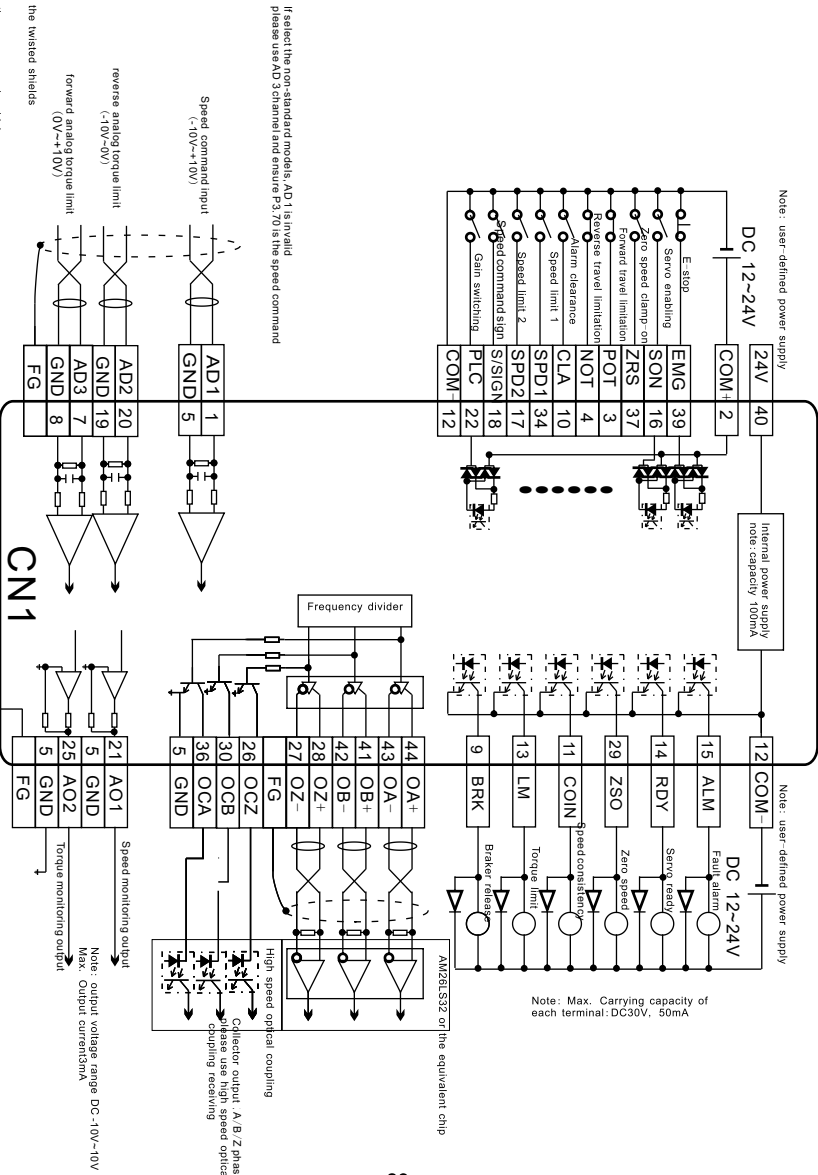

### 4.3 Standard wiring of the torque mode

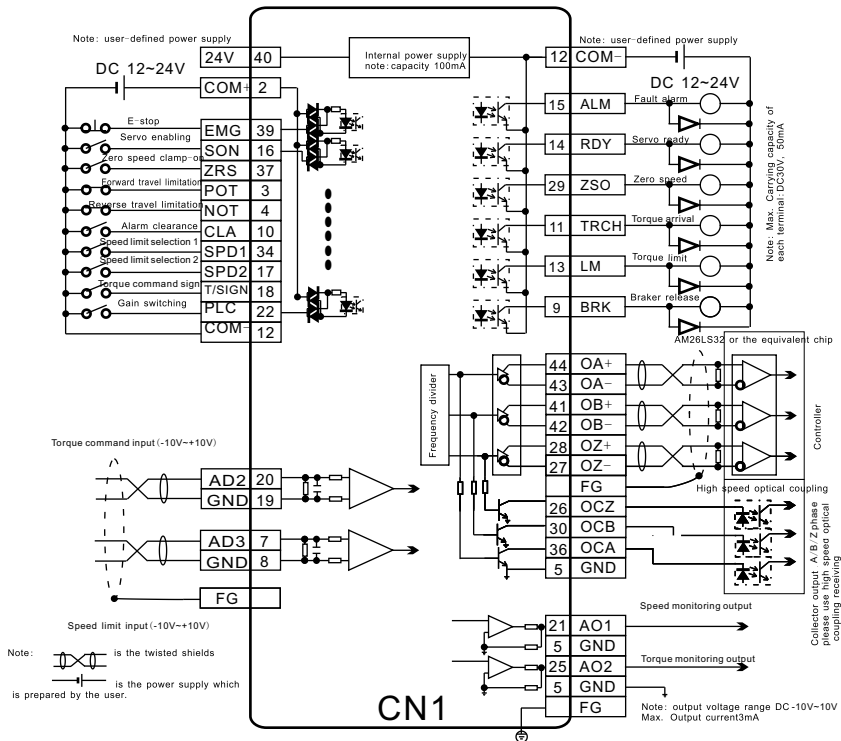

### 4.4 CN1 functions

#### 4.4.1 Pins of CN1 terminals

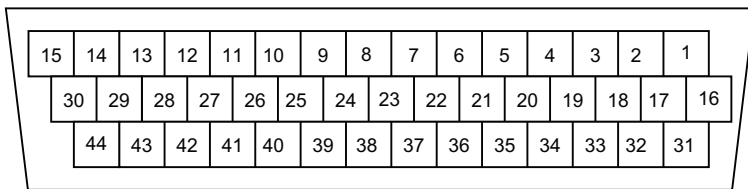

CN1 pin arrangement

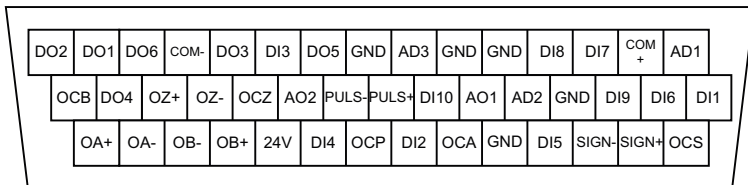

CN1 signal arrangement



#### 4.4.2 Definition of CN1 terminals

Pin	Sign	Function	Pin	Sign	Function
1	AD1	Analog command speed	23	PULS+	Differential command pulse +
2	COM+	Control signal power supply +	24	PULS-	Differential command pulse -
3	DI7	Digital input 7	25	AO2	Digital monitoring output 2
4	DI8	Digital input 8	26	OCZ	Open collector output of Z phase
5	GND	Analog signal ground	27	OZ-	Differential output - of Z phase
6	GND	Analog signal ground	28	OZ+	Differential output + of Z phase
7	AD3	Analog input 3	29	DO4	Digital output 4
8	GND	Analog signal ground	30	OCB	Open collector output of B phase
9	DO5	Digital output 5	31	OCS	Open collector command direction
10	DI3	Digital input 3	32	SIGN+	Differential command direction +
11	DO3	Digital output 3	33	SIGN-	Differential command direction -
12	COM-	Control signal power supply -	34	DI5	Digital input 5
13	DO6	Digital output 6	35	GND	Analog signal ground
14	DO1	Digital output 1	36	OCA	Open collector output of A phase
15	DO2	Digital output 2	37	DI2	Digital input 2
16	DI1	Digital input 1	38	OCP	Open collector command pulse
17	DI6	Digital input 6	39	DI4	Digital input 4
18	DI9	Digital input 9	40	24V	Internal 24V power supply
19	GND	Analog signal ground	41	OB+	Differential output + of B phase
20	AD2	Analog command torque	42	OB-	Differential output - of B phase
21	AO1	Analog monitoring output 1	43	OA-	Differential output - of A phase
22	DI10	Digital input 10	44	OA+	Differential output + of A phase

#### 4.4.3 Power supply signal

Sign	Pin	Name	Function
24V	40	Internal 24V power supply	COM- is the ground terminal of the 24V power. Its capacity is 100mA. If the actual load is higher than this value, the user shall provide the power supply by themselves.
GND	5,6,8,19,35	Signal ground	The ground of the internal power supply (except the 24V power supply) of the servo drive, it is also the ground of the phase A/B/Z open-collector signal of the encoder and

Sign	Pin	Name	Function
			the analog output signal. It is isolated with COM-.
COM+	2	“+” pole of external DC power supply 12V~24V	<ul style="list-style-type: none"> <li>If the DC power supply is provided by the user, the positive pole of the DC power supply must be connected to this terminal.</li> <li>If the 24V power supply of the drive is used, the 24V terminal must be connected on this terminal.</li> </ul>
COM-	12	“-” pole of power supply	<ul style="list-style-type: none"> <li>Local 24V power ground</li> <li>“-” pole of external DC power supply 12V~24V</li> </ul>
FG	Enclosure	Enclosure ground	The enclosure of CN1 terminal is connected with the enclosure of the drive

#### 4.4.4 Configuration table in different modes

Pin	Sign	Name	Position/fully-closed loop mode			Speed mode			Torque mode		
			Default value	Key	Function	Default value	Key	Function	Default value	Key	Function
16	DI1	Digital input 1	0x03	SON	Servo enabling	0x03	SON	Servo enabling	0x03	SON	Servo enabling
37	DI2	Digital input 2	0x0D	ZRS	Zero speed clamp	0x0D	ZRS	Zero speed clamp	0x0D	ZRS	Zero speed clamp
10	DI3	Digital input 3	0x04	CLA	Alarm clearance	0x04	CLA	Alarm clearance	0x04	CLA	Alarm clearance
39	DI4	Digital input 4	0x16	EMG	Emergency stop	0x16	EMG	Emergency stop	0x16	EMG	Emergency stop
34	DI5	Digital input 5	0x19	SC1	Molecule 1 of electric gear ratio	0x0A	SPD1	Internal speed command selection 1	0x0A	SPD1	Internal speed command selection 1
17	DI6	Digital input 6	0x1A	SC2	Molecule 2 of electric gear ratio	0x0B	SPD2	Internal speed command selection 2	0x0B	SPD2	Internal speed command selection 2
3	DI7	Digital input 7	0x01	POT	Prohibition of the	0x01	POT	Prohibition of the	0x01	POT	Prohibition of the

Pin	Sign	Name	Position/fully-closed loop mode			Speed mode			Torque mode		
			Default value	Key	Function	Default value	Key	Function	Default value	Key	Function
					positive drive			positive drive			positive drive
4	DI8	Digital input 8	0x02	NOT	Prohibition of the negative drive	0x02	NOT	Prohibition of the negative drive	0x02	NOT	Prohibition of the negative drive
18	DI9	Digital input 9	0x07	RPC	Retention pulse clear	0x0E	S-SIGN	Speed command sign	0x0F	T-SIGN	Torque command sign
22	DI10	Digital input 10	0x08	PLL	Command pulse disabled	0x06	PLC	Gain switching	0x06	PLC	Gain switching
14	DO1	Digital output 1	0x01	RDY	Servo ready output	0x01	RDY	Servo ready output	0x01	RDY	Servo ready output
15	DO2	Digital output 2	0x03	ALM	Fault output	0x03	ALM	Fault output	0x03	ALM	Fault output
11	DO3	Digital output 3	0x07	PLR	Positioning finished	0x09	COIN	Speed matching	0x10	TRCH	Torque arrival
29	DO4	Digital output 4	0x0D	ZSO	Speed zero output	0x0D	ZSO	Speed zero output	0x0D	ZSO	Speed zero output
9	DO5	Digital output 5	0x05	BRK	Signal clearing of external breaker	0x05	BRK	Signal clearing of external breaker	0x05	BRK	Signal clearing of external breaker
13	DO6	Digital output 6	0x0E	LM	Torque limiting	0x0E	LM	Torque limiting	0x0E	LM	Torque limiting

Pin	Sign	Name	MotionNet mode		
			Default value	Key	Function
16	DI1	Digital input 1	0x00	OFF	Invalid
37	DI2	Digital input 2	0x00	OFF	Invalid

Pin	Sign	Name	MotionNet mode		
			Default value	Key	Function
10	DI3	Digital input 3	0x00	OFF	Invalid
39	DI4	Digital input 4	0x00	OFF	Invalid
34	DI5	Digital input 5	0x00	OFF	Invalid
17	DI6	Digital input 6	0x103	SON	Servo enabling
3	DI7	Digital input 7	0x107	RPC	Retention pulse clear
4	DI8	Digital input 8	0x104	CLA	Alarm clearance
18	DI9	Digital input 9	0x116	EMG	Emergency stop
22	DI10	Digital input 10	0x00	OFF	Invalid
14	DO1	Digital output 1	0x05	BRK	Signal clearing of external breaker
15	DO2	Digital output 2	0x01	RDY	Servo ready output
11	DO3	Digital output 3	0x03	ALM	Fault output
29	DO4	Digital output 4	0x07	PLR	Positioning finished
9	DO5	Digital output 5	0x0D	ZSO	Speed zero output
13	DO6	Digital output 6	0x0E	LM	Torque limiting

### Function description of the digital input:

Signal name	Sign	Function No.	Available mode			
Prohibition of the positive drive	POT	0x01	P	S	T	F
Prohibition of the negative drive	NOT	0x02	P	S	T	F

Please refer to the detailed description of P3.40:

When P3.40 is set to be 0 and the disabled input of positive drive is valid, the motor stops at the current position, only negative command input is available. If the disabled input of negative drive is valid, the motor stops at the current position, only positive command input is available.

P3.40 is 1, the function is invalid;

P3.40 is 2, and the positive/negative drive disabled input is valid, the drive alarms.

Signal name	Sign	Function number	Available mode			
Servo enabling	SON	0x03	P	S	T	F

This function is the control signal of the servo enabled and disabled.

When valid, the drive will provide power to the motor and when invalid, the drive will cut off the connection.

Signal name	Sign	Function number	Available mode			
Alarm clear	CLA	0x04	P	S	T	F

This function is the control signal of alarm clear when the drive alarms.

Some alarms can not be cleared by this function. Please refer to section 10.4 for detailed information.

Signal name	Sign	Function number	Available mode			
Control mode switching	MCH	0x05	P	S	T	
This function is the control signal of mode switching when P0.03 is 3, 4 and 5. When the control mode is 0, 1, 2, 6 and 7 the function is invalid.						

Signal name	Sign	Function number	Available mode			
Gain switching	PLC	0x06	P	S	T	F
This function is the control signal of the 1 <sup>st</sup> and 2 <sup>nd</sup> gain switching.						

Signal name	Sign	Function number	Available mode			
Retention pulse clear	RPC	0x07	P			F
This function is the control signal of retention pulse clear and the detailed operation is relative to the setting of P3.45. P3.45=0 means electrical level clear. When the digital input is valid, retention pulse will be 0; P3.45=1 means rising edge clear. When the digital input triggers retention pulse clear from the edge of 0->1, only clear once.						

Signal name	Sign	Function number	Available mode			
Command pulse disabled	PLL	0x08	P			F
This function is the control signal of stopping receiving the command pulse and the detailed operation is relative to the setting of P3.44. P3.44 is 0, the function is valid and when P3.44 is 1, the function is invalid.						

Signal name	Sign	Function number	Available mode			
Torque limit switching	TLC	0x09	P	S		F
This function is the control signal of the 1 <sup>st</sup> and 2 <sup>nd</sup> torque limit switching. Please refer to the instruction of P0.09.						

Signal name	Sign	Function number	Available mode			
Internal speed command 1	SPD1	0x0A		S	T	
Internal speed command 2	SPD2	0x0B		S	T	
Internal speed command 3	SPD3	0x0C		S		
There are 1~8 signal selections for the internal speed command and 1~4 for the internal speed limit.						

Control mode	P0.40 setting value	SPD3	SPD2	SPD1	Parameters and setting value
Speed mode	0	0	0	0	P0.46 internal speed 1
		0	0	1	P0.47 internal speed 2
		0	1	0	P0.48 internal speed 3
		0	1	1	P0.49 internal speed 4
		1	0	0	P0.50 internal speed 5
		1	0	1	P0.51 internal speed 6
		1	1	0	P0.52 internal speed 7
		1	1	1	P0.53 internal speed 8
Torque mode	0	0	0	0	P0.46 speed limit 1
		0	0	1	P0.47 speed limit 2
		0	1	0	P0.48 speed limit 3
		0	1	1	P0.49 speed limit 4

Signal name	Sign	Function number	Available mode		
Zero speed clamp	ZRS	0x0D		S	T
This function is the control signal of zero speed clamp and please refer to P0.58 for detailed information.					

Signal name	Sign	Function number	Available mode		
Speed command sign	S-SIGN	0x0E		S	
This function is the control signal of speed command sign in the speed control mode. If P0.41 is 1, the input function is valid, and when the setting is 0, the function is invalid.					

Signal name	Sign	Function number	Available mode		
Torque command sign	T-SIGN	0x0F			T
This function is the control signal of torque command sign in the speed control mode. If P0.61 is 1, the input function is valid, and when the setting is 0, the function is invalid.					

Signal name	Sign	Function number	Available mode		
Internal position command 1	POS1	0x10	P		
Internal position command 2	POS2	0x11	P		
Internal position command 3	POS3	0x12	P		
Internal position command 4	POS4	0x13	P		

Signal name	Sign	Function number	Available mode		
<p>These functions are the selections of 0~15 in the point control mode. It has the same function of P5.20 and is valid when P0.20 is 2.</p> <p>The combination of 4 digital input is used to select the different target position of P6.01~P6.31 and the corresponding target speed, ACC/DEC time and the delay time of P5.21~P5.68.</p>					
Control mode	POS4	POS3	POS2	POS1	Parameters and setting value
Position mode	0	0	0	0	P6.01[00 position]
	0	0	0	1	P6.03[01 position]
	0	0	1	0	P6.05[02 position]
	0	0	1	1	P6.07[03 position]
	0	1	0	0	P6.09[04 position]
	0	1	0	1	P6.11[05 position]
	0	1	1	0	P6.13[06 position]
	0	1	1	1	P6.15[07 position]
	1	0	0	0	P6.17[08 position]
	1	0	0	1	P6.19[09 position]
	1	0	1	0	P6.21[10 position]
	1	0	1	1	P6.23[11 position]
	1	1	0	0	P6.25[12 position]
	1	1	0	1	P6.27[13 position]
	1	1	1	0	P6.29[14 position]
1	1	1	1	P6.31[15 position]	

Signal name	Sign	Function number	Available mode
External fault	EXT	0x14	P   S   T   F
<p>This function is the signal of external fault.</p> <p>If the digital input is valid, the drive will report Er10-3 and stop.</p>			

Signal name	Sign	Function number	Available mode
Inertia ratio switching	JC	0x15	P   S   T   F
<p>This function is the control signal of inertia ratio switching of the 1<sup>st</sup> inertia ratio and 2<sup>nd</sup> inertia ratio.</p> <p>When the digital input is valid, the internal software use P1.02; and when invalid, use P1.01.</p>			

Signal name	Sign	Function number	Available mode			
E-stop	EMG	0x16	P	S	T	F
<p>This function is the control signal of E-stop.</p> <p>If P3.41 is set to be 0 and when the digital input is valid, the drive will stop to report Er10-4.</p>						

Signal name	Sign	Function number	Available mode			
HOME switch input	HOME	0x17	P			
<p>This function is the input signal of HOME SWITCH.</p> <p>When the drive carries out HOME action, in some HOME mode, if the digital input is detected to be valid, HOME is finished. Refer to P5.10 for information..</p>						

Signal name	Sign	Function number	Available mode			
HOME trigger	HTRG	0x18	P			
<p>This function is the trigger control signal of HOME function, and the rising edge is valid.</p> <p>In the bus control mode, the digital input function has the same function with P5.15.</p>						

Signal name	Sign	Function number	Available mode			
Molecule 1 of electric gear ratio	SC1	0x19	P			F
Molecule 2 of electric gear ratio	SC2	0x1A	P			F
<p>The function is the selection signal of the electric gear ratio, up to 4 groups of electric gears can be switched.</p> <p>Before using the function, it is necessary to set P0.22 as 0 and then set the electric gear ratio (P0.25~P0.29).</p> <p><b>Note:</b> If the electric gear is switched by digital value, it is necessary to set P4.10 as 0.</p>						
	SC1	SC2	Electric gear ratio			
			Molecule	Denominator		
	0	0	P0.25	P0.26		
	0	1	P0.27	P0.26		
	1	0	P0.28	P0.26		
	1	1	P0.29	P0.26		

Signal name	Sign	Function number	Available mode			
Point control trigger	TRIG	0x1B	P			
<p>In the point control mode, it needs to be used with internal position command 1~4.</p> <p>During using, select the target step by the internal position command selection 1~4, and then</p>						



trigger the switching action.

Signal name	Sign	Function number	Available mode			
Vibration control switching input	VS-SEL	0x1C	P			F
<p>The function is the control signal of the 1<sup>st</sup> vibration control frequency and 2<sup>nd</sup> vibration control frequency.</p> <p>When the digital input is valid, the internal software use P1.38; when invalid, use P1.36.</p>						

Signal name	Sign	Function number	Available mode			
Fast stop	Q-STOP	0x1D	P	S	T	F
<p>This function is the control signal of the fast stop of external control.</p> <p>When the digital input is valid, the motor decelerates to 0 from current speed at the curve set by P0.69; when the input is invalid, the motor will restore to the operation state before stop.</p>						

Signal name	Sign	Function number	Available mode			
Point control stop	PTP-ST	0x1E	P			
<p>This function is the control signal of stopping point operation in the point control mode. In the bus control mode, it has the same function with P5.20 when it is 100.</p>						

#### Digital output instruction:

Signal name	Sign	Function number	Available mode			
Servo ready output	RDY	0x01	P	S	T	F
<p>This function is the state signal of the drive.</p> <p>When valid, the drive can be enabled and provide power to the motor and when invalid, the drive gives no response to the command.</p>						

Signal name	Sign	Function number	Available mode			
Servo operation output	RUN	0x02	P	S	T	F
<p>This function is the state signal of the enabled drive.</p> <p>When valid, the motor is power on.</p>						

Signal name	Sign	Function number	Available mode			
Fault output	ALM	0x03	P	S	T	F
<p>The function is the state signal when the drive displays the fault alarm.</p> <p>When it is valid, the drive has fault currently.</p>						

Signal name	Sign	Function number	Available mode			
Signal clearing of external breaker	BRK	0x05	P	S	T	F
<p>The function is the control signal of output motor breaker.</p> <p>When it is valid, the breaking controlled is cleared and then receive the motor control command; when invalid, the controller will break off.</p>						

Signal name	Sign	Function number	Available mode			
Position command or not	PCMD	0x06	P			F
<p>The function is the state signal of whether there is position command or not.</p> <p>When it is valid, the motor is controller by the non-zero position command.</p>						

Signal name	Sign	Function number	Available mode			
Positioning finished	PLR	0x07	P			F
<p>The function is the state signal of positioning finished.</p> <p>When it is valid, the positioning is finished.</p>						

Signal name	Sign	Function number	Available mode			
Control mode switching	MCHS	0x08	P	S	T	
<p>When the signal is valid, control mode 1 is switched into mode 2; if the function output is invalid, the control mode 2 is switched back to mode 1.</p>						

Signal name	Sign	Function number	Available mode			
Speed matching	COIN	0x09	P	S	T	F
<p>The function is the state signal of speed matching.</p> <p>When it is valid, the deviation between current speed feedback and speed command is in the range of P3.53.</p>						

Signal name	Sign	Function number	Available mode			
Speed reaching	SR	0x0A	P	S	T	F
<p>The function is the state signal of the speed reaching.</p> <p>When it is valid, the current speed feedback is in the setting value of P3.54.</p>						

Signal name	Sign	Function number	Available mode			
Speed limiting	SL	0x0B			T	

The function is the state signal of speed limiting.  
 When it is valid, in the torque mode, if the current torque does not reach the torque command, the speed feedback is in the speed limiting.

Signal name	Sign	Function number	Available mode			
Speed command or not	SCMD	0x0C	P	S	T	F
The function is the state signal of whether there is speed command or not. When it is valid, non-zero speed command controls the motors.						

Signal name	Sign	Function number	Available mode			
Speed zero output	ZSO	0x0D	P	S	T	F
The function is the state signal of whether the current speed feedback is 0.						

Signal name	Sign	Function number	Available mode			
Torque limiting	LM	0x0E	P	S	T	F
The function is the state signal of torque limiting.						

Signal name	Sign	Function number	Available mode			
Zeroing finished	HEND	0x0F	P			
The function is the state signal of zero finished. When it is valid, the drive has finished return to zero and found zero successfully.						

Signal name	Sign	Function number	Available mode			
Torque reaching	TRCH	0x10			T	
The function is the state signal of torque reaching. When it is valid, the deviation between current torque output and torque command will be in the setting range of P3.59; there is 5% detection retention.						

#### 4.4.5 Pulse input signals and functions

Sign	Pin	Name	Function
OCP	38	Position command pulse input 1	<ul style="list-style-type: none"> <li>In the position control mode, as the position command input terminal</li> <li>In other control mode, the terminal is invalid</li> <li>Allowed Max. input pulse frequency: 4MHz in differential mode, 200kHz in open-collector mode.</li> </ul>
PULS+	23		
PULS-	24		
OCS	31	Position	

Sign	Pin	Name	Function
SIGN+	32	command pulse input 2	
SIGN-	33		

#### 4.4.6 Analog input signals and functions

Sign	Pin	Name	Function
AD1	1	Analog command speed	<ul style="list-style-type: none"> <li>AD1 precision is 16-bit and AD2,AD3 precision is 12-bit</li> <li>If the model which is not standard is used as the speed control, AD1 channel is invalid, please take AD3 as the speed command input interface and modify P3.70 as the speed command</li> <li>External analog input terminals. The input impedance is 10kΩ. The input voltage range is -10V~+10V. A voltage exceeding ±11V may damage the drive</li> <li>The range and offset setting and function definition can be set</li> </ul>
AD2	20	Analog command torque	
AD3	7	Analog input 3	
GND	5,6,8, 19,35	Signal ground	

#### 4.4.7 Encoder output signals and functions

Sign	Pin	Name	Function
OA+	44	A phase output	<ul style="list-style-type: none"> <li>Output the frequency divided encoder signal, comply with the standard of TIA/EIA-422-B</li> </ul>
OA-	43		
OB+	41	B phase output	<ul style="list-style-type: none"> <li>The output phase A pulse and phase B pulse is still orthogonal. When it rotates forward, phase B leads phase A by 90°. When it rotates in reverse, phase A leads phase B by 90°.</li> </ul>
OB-	42		
OZ+	28	Z phase output	<ul style="list-style-type: none"> <li>Frequency division and frequency multiplication with any integer and decimal fraction is allowable</li> <li>The output signals have no isolation.</li> </ul>
OZ-	27		
OCA	36	A phase output	<ul style="list-style-type: none"> <li>Output the open-collector signal of phase A, without isolation</li> </ul>
OCB	30	B phase output	<ul style="list-style-type: none"> <li>Output the open-collector signal of phase B, without isolation</li> </ul>
OCZ	26	Z phase output	<ul style="list-style-type: none"> <li>Output the open-collector signal of phase Z, without isolation</li> </ul>

#### 4.4.8 Analog output signals and functions

Sign	Pin	Name	Function
AO1	21	Analog	Its output function definition can be set, and the range and

Sign	Pin	Name	Function
		monitoring output 1	offset settings can be set
AO2	25	Analog monitoring output 2	Its output function definition can be set, and the range and offset settings can be set

### 4.5 CN1 wiring

#### 4.5.1 Wiring of digital input circuit

Connection diagram when the power supply is self-provided by user:

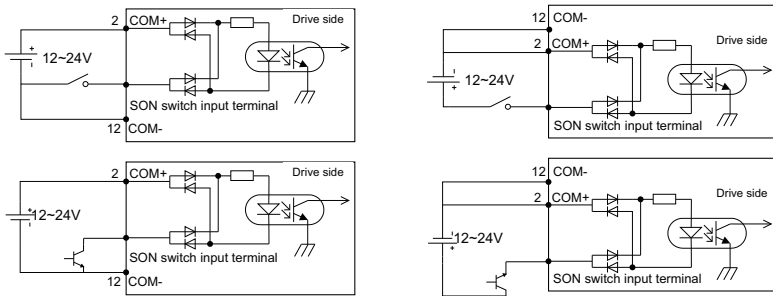

Connection diagram when the local power supply is used:

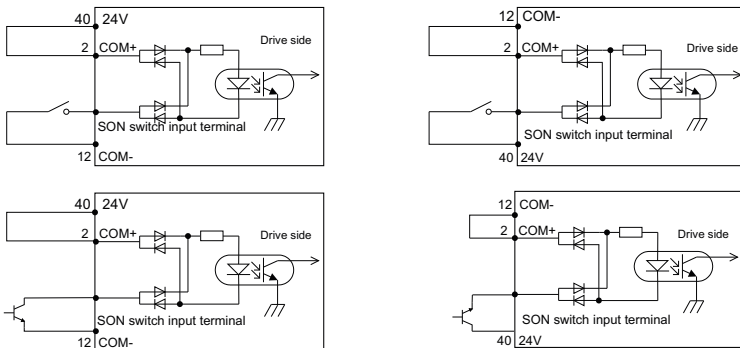

- ◆ The ON-OFF input circuit can be connected with mechanical switch connection and the open-collector connection of audion shown in the figure.
- ◆ The user can use either the 24V power supply (it only can provide 100mA current) of the servo drive or 12V~24V power supply provided by the user.

### 4.5.2 Wiring of the pulse input circuit

Connect method 1: the differential connection

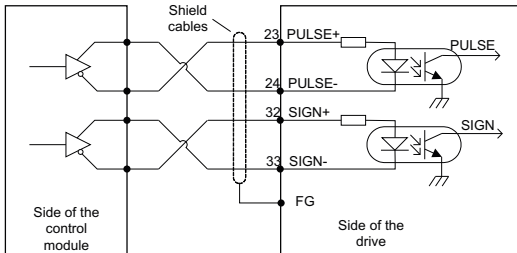

- ◆ The maximum frequency of input pulse is 4MHz and the input signal voltage is  $\pm 5V$ ;
- ◆ With the best anti-noise capability, this signal transmit method is recommended as the preferred.

Connection method 2: the open collector circuit 1

The control module is NPN (the common negative pole)

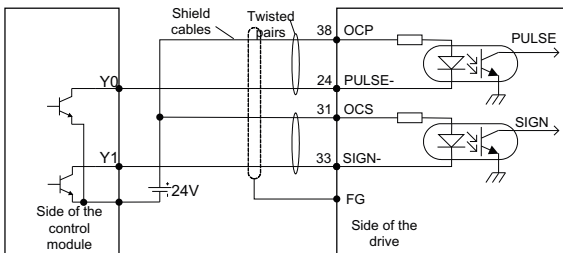

The control module is PNP module (the common positive pole):

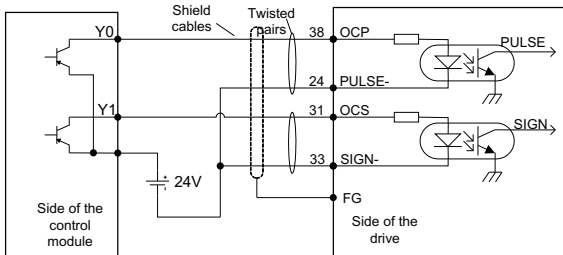

- ◆ The Max. input pulse frequency is 200kHz; apply the local 24V power supply((it only can provide 100mA current)) or the user-provided 24V power supply without the current-limiting resistor. Generally, most of Japanese PLC (such as Mitsubishi, Panasonic and OMRON) is NPN module, while most of European PLC (such as Siemens) is PNP module.

Connection method 3: the open collector circuit 2

The control module is NPN (the common negative pole):

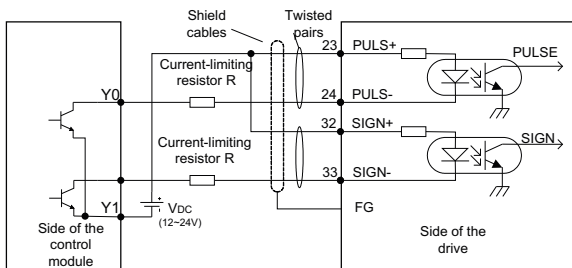

The control module is PNP (the common positive pole):

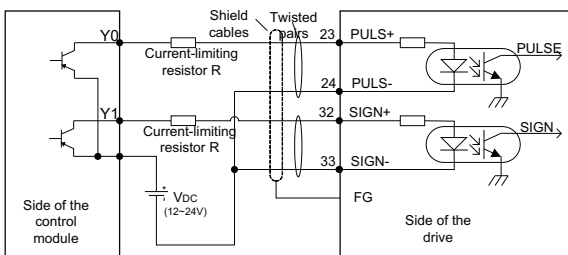

- ◆ The Max. input pulse frequency is 200kHz; apply the local 24V power supply (it only can provide 100mA current) or the user-provided 12~24V power supply with the current-limiting resistor(the resistance is selected as the below table). Generally, most of Japanese PLC (such as Mitsubishi, Panasonic and OMRON) is PNP module, while most of European PLC (such as Siemens) is NPN module.

VDC	Resistor parameters
12V	1K ,1/4W
24V	2K ,1/3W

$$\frac{V_{DC}}{R + 68} \approx 10 \text{ (mA)}$$

For all the 3 methods, shielded twisted-pair must be used and the length must be less than 3m.

### 4.5.3 Wiring of the analog input circuit

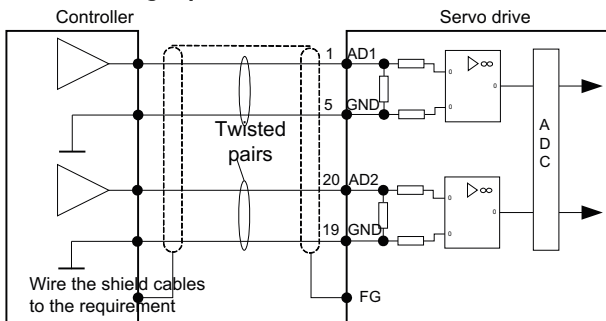

- ◆ There are three analog input circuits, AD1, AD2 and AD3, AD1 precision is 16-bit (optional for standard models), AD2 and AD3 precision is 12-bit (standard). The input impedance is 10kΩ. The input voltage range is -10V~+10V. If the voltage is higher than ±11V, the circuits may damage.
- ◆ If the model which is not standard is used as the speed control, AD1 channel is invalid, please take AD3 as the speed command input interface and modify P3.70 as the speed command

### 4.5.4 Wiring of ON-OFF output circuit

Connection diagram when the power supply is self-provided by user:

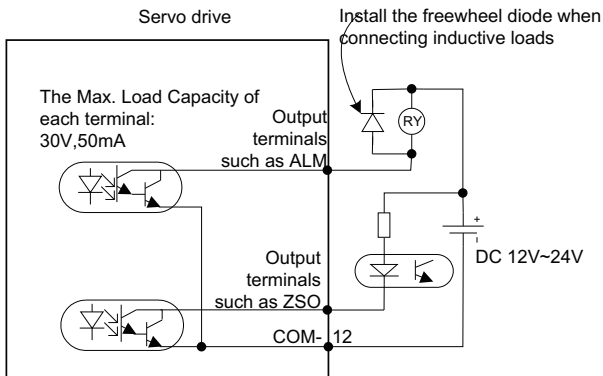

Connection method when the local power supply is used:



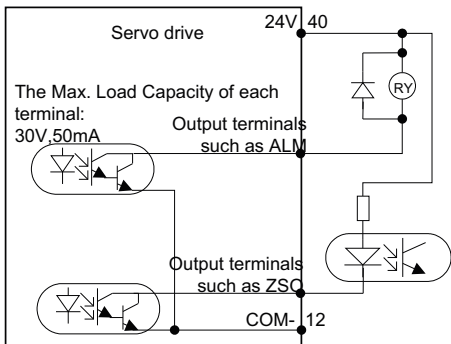

- ◆ There are 6 digital output circuits in total and all of them adopt the open-collector output as shown in the figure. They can be used to drive the relay coil or optical coupled load. The loading capacity is as shown in the figure.
- ◆ When inductive loads such as relay coil are connected, a free wheel diode must be fitted as shown in the figure. Otherwise the drive will be damaged.
- ◆ The local 24V power supply only can provide 100mA current. If the actual load current is larger than 100mA, the user should provide the power supply by themselves. The recommended capacity is greater than 500mA.

### 4.5.5 Wiring of the frequency division output circuit of the encoder feedback signal

Differential mode:

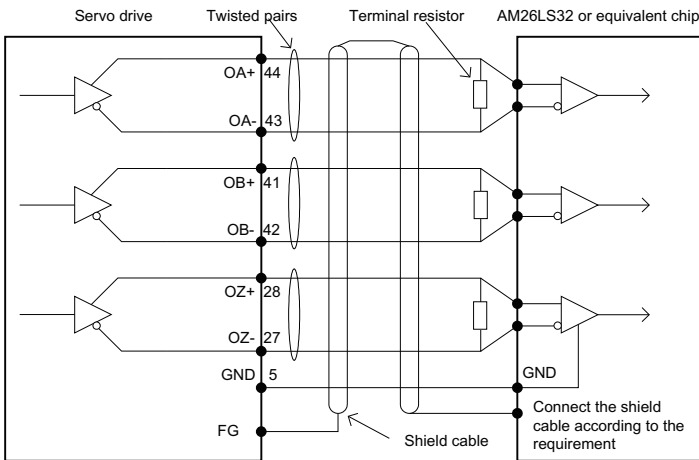

Open-collector mode:

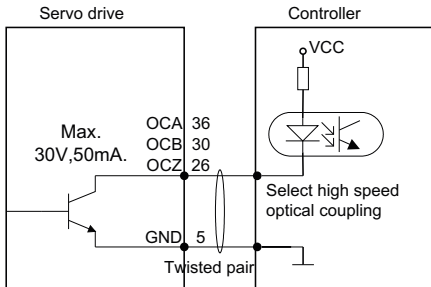

- ◆ Phase A, B and Z all provide differential output and open-collector output signals.
- ◆ For differential output signal, to use AM26C32 or equivalent differential receiving chip and be sure to fit a terminal matching resistor of about 220Ω is recommended .
- ◆ For the phase A, B, Z signal of open-collector output, as the signal pulse width is very narrow, the user shall use high speed optical coupler to receive this signal.
- ◆ Both kinds of output circuits have no isolation.

### 4.5.6 Wiring of the analog output circuit

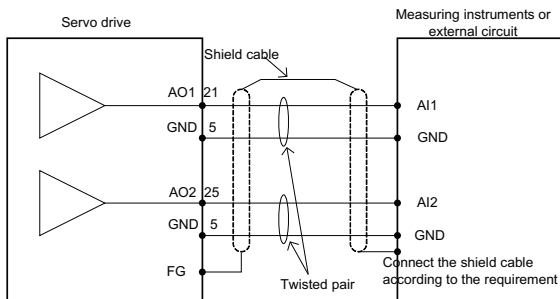

- ◆ There are two analog output circuits in all. The output voltage range is -10V~10V. The Max output current is 3mA.

### 4.5.7 Wiring of the electromagnetic brake

If the servo drive is used in the vertical drop applications, the electromagnetic brake can be used to stop and keep the dropping speed. The wiring diagram is:

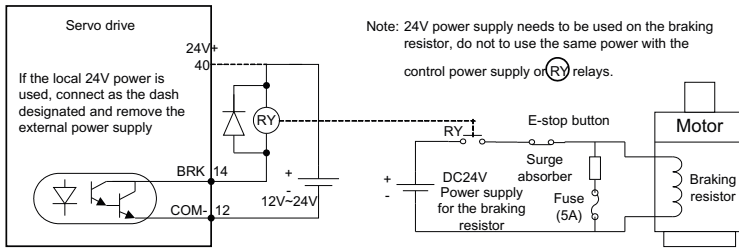

- ◆ 24V power supply special for the electromagnetic brake can not be used with the control signal;
- ◆ (RY) is the relay wires, please pay attention to the direction of the diode;
- ◆ The electromagnetic brake is used to keep the speed, other than stop;
- ◆ Please install the external braking devices besides the electromagnetic brake.

# Running and operation

# 5

## 5.1 Running

### 5.1.1 First powering on

Please check as follows before power on:

#### 1) Wiring

- ◆ The power supply of the servo drive (L1, L2, L3, L1C, L2C) should be connect with proper techniques;
- ◆ The output phase of the servo drive (U, V and W) should be the same as that of the cables of the servo drive;
- ◆ There is no short circuit between the output of the servo drive (U, V and W) and the input power supply (L1, L2 and L3);
- ◆ All wiring comply with the standard wiring shown in section 4;
- ◆ Ensure the external terminal (SON) for servo enabling is set to OFF;
- ◆ Ensure the servo drive and the servo motor are grounded to the earth properly;
- ◆ When using external braking resistor, the short circuit wire between B2-B3 on X2 terminal should be removed;
- ◆ Do not put voltage above DC24V on CN1;
- ◆ The press threshold is among the designated range.

#### 2) Environment

- ◆ There are no foreign objections, such as metal and other wire lead which can cause short circuit of signal and power wires.

#### 3) Mechanical parts

- ◆ The installation of the servo drive and the connection of the bear are reliable;
- ◆ The servo motor and the machines are available to run;
- ◆ Do not run the motor at negative load (the direction of the output torque of the motor reverses to the speed direction).

If all above items are checked OK, switch on the power supply:

#### 5.1.1.1 Sequence of powering ON/OFF

The control circuit and the main circuit of the drive are supplied separately. In principle, when powering on, switch on the power supply of the control circuit (terminals L1C, L2C) first and then switch on the power supply of the main circuit (terminals L1, L2, L3). When powering off, switch off the power supply of the main circuit first and then switch off the power supply of the control circuit.

After switching on the control circuit power supply and before switching on the main circuit power

supply, R0.30 will display "0" and after power on of the main circuit, R0.30 will display "2" and the servo drive can be enabled.

**5.1.1.2 Checking after powering-on**

After switching on both of the control circuit and main circuit power supplies, if the power supply is OK, the LED indicator will display 0 first and then display 8. If there is no fault alarm of the servo drive, the LED on the front panel displays the current speed of the servo motor as default. The default parameter can be set through parameter P0.15. If there is a fault of the servo drive, the LED displays current alarm sign and flickers. Please fix the fault by referring to chapter 9.1.

**5.1.2 Trial jogging**

Trial jogging can check whether the servo drive and the servo motor are intact and conduct preliminary debugging of the system including the servo drive, servo motor and peripheral equipments. Run the servo motor by JOG operation after ensuring that the wiring is correct and there is no fault alarm and no abnormal running, See chapter 5.2.5 for detailed instructions. Before jog running, ensure:

- ◆ The motor isn't in running state. If the motor is running, JOG operation is invalid;
- ◆ The load inertia shouldn't exceed 15 times of the motor inertia. Otherwise it may cause serious mechanical vibration;
- ◆ The jog speed can be set via parameter P0.05.
- ◆ The accelerating/decelerating time during jogging can be set via parameters P0.54, P0.55 and P0.56, P0.57.

**5.1.3 Running at the position control mode**

Simple connection:

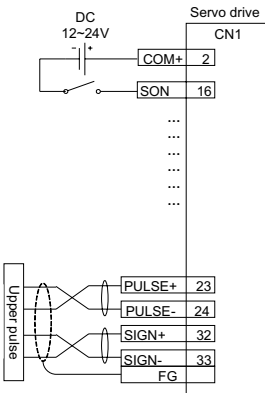

Parameter	Function	Setting value
P0.03 <sup>1</sup>	Control mode selection	0
P0.21 <sup>1</sup>	Command pulse input selection	Set according to the requirement
P0.22 <sup>1</sup>	The pulse number when the motor rotates a cycle	Set according to the requirement
P0.23 <sup>1</sup>	Pulse input	Set according to the requirement
P0.24 <sup>1</sup>	Pulse input direction reverse	0

Figure 5-1 Simple connection of the position control mode

Steps:

1. Complete the connection between the drive and the servo motor.
2. Set P0.03 to "0", the position control mode.
3. Ensure the pulse output of the upper controller and adjust P0.23. Keep the pulse type is the same as that of the upper controller. Please refer to the instruction of P0.23.
4. Connect the corresponding terminal of CN1 and ensure the pulse wires (differential output and open collector output) and adjust P0.21. Please refer to the instruction of P0.21.
5. Disconnect the control power supply after the modification of P0.03, P0.21, P0.23 and then power on again.
6. Connect CN1 to the drive and apply the power supply. Control the connection between SON and COM-. And then, the servo enters into the locking state.
7. Send the low frequency pulse command from the upper controller and rotate the motor at low speed.
8. Ensure the rotating direction of the motor is as the designated. The direction can be modified through the upper controller or operate on P0.24.
9. Ensure the pulse number is as the designated. Please refer to the instruction of P0.22, P0.25 and P0.26.

### 5.1.4 Running at the speed control mode

Simple connection

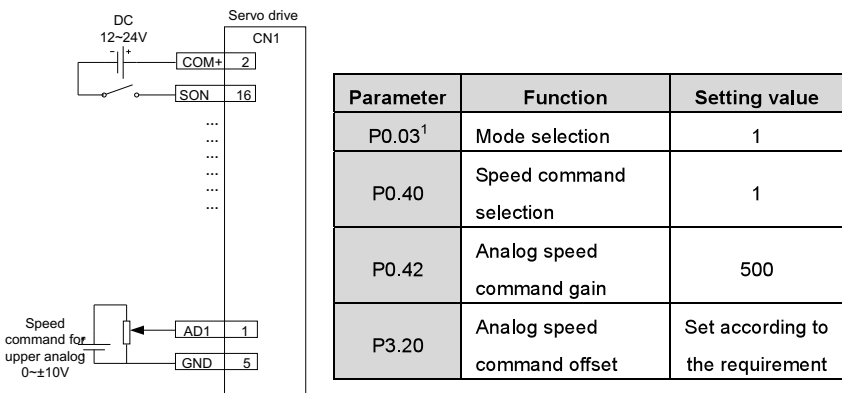

Figure 5-2 Simple connection of the speed control mode

Steps:

1. Complete the connection between the drive and the servo motor.
2. Set P0.03 to "1", the speed control mode.
3. It is necessary to disconnect the control power supply after saving the modified value of P0.03. And it will be valid after repowering on.
4. Set P0.40 to "1", external analog speed command mode.
5. Set P0.42 to the required value. Please refer to the instruction of P0.42.
6. Connect the corresponding terminals of CN1.
7. Connect the CN1 to the drive and power on. Control the connection between SON and COM-. Then the servo enters into the locking state.
8. The motor shaft may rotate at a low speed if there is no upper command voltage. It needs to adjust P3.20. Please refer to the detailed instruction of P3.20.

### 5.1.5 Running at the torque control mode

Simple connection:

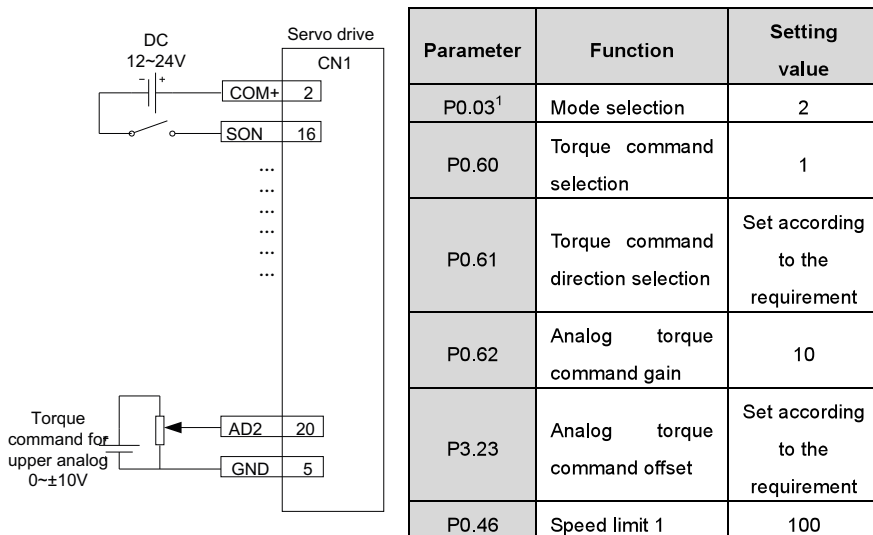

Figure 5-3 Simple connection of the torque control mode

Steps:

1. Complete the connection between the drive and the servo motor.
2. Set P0.03 to "2", the torque control mode.
3. It is necessary to disconnect the control power supply after saving the modified value of P0.03. And it will be valid after repowering on.

4. Set P0.60 to "1", external analog torque command mode.
5. Set P0.61 to the required value. Please refer to the instruction of P0.61.
6. Set P0.62 to the required value. Please refer to the instruction of P0.62.
7. Connect the corresponding terminals of CN1.
8. Connect the CN1 to the drive and power on. Control the connection between SON and COM-. Then the servo enters into the locking state.
9. The motor shaft may rotate at a low speed if there is no upper command voltage. It needs to adjust P3.23. Please refer to the detailed instruction of P3.23.
10. In the torque mode, please adjust the speed limit and set P0.46 to the required value. Please refer to the detailed instruction of P0.46.

### 5.1.6 Parameter setting before running the servo

Parameter setting must be conducted before running the servo. Relevant parameters can be set via the front panel or communication to meet the function and performance requirements of the site application. See chapter 6 for the detailed description of all parameters of the servo drive. Some of these parameters need to be set according to the site application demand. For examples, pulse input mode, electronic gear, frequency division coefficient of encoder output, upper/lower limit of analog input, etc. Some of these parameters need to be set according to the site debugging. For example, the parameters of the regulator loop which affect the system performance and other similar parameters. For most parameters the factory default values are appropriate.

Hereunder only some necessary parameters are listed:

#### 1) Mode setting

The control mode (position mode, speed mode, torque mode) can be set through setting parameter P0.03 according to the control requirements on the site. The mode will be valid after powering on.

#### 2) Command input

Set or enter relevant commands to control the position, speed or torque of the servo motor's shaft according to the setting of parameter P0.03.

- ◆ In the position, fully close loop mode: pulse command (3 kinds of input mode), internal torque limit command or external analog torque limit command;
- ◆ In the speed mode: internal speed command or external analog speed command, internal torque limit command or external analog torque limit command;
- ◆ In the torque mode: internal torque command or external analog torque command, internal speed limit command or external analog speed limit command.

### 5.1.7 Servo enabling

Enable the servo via the external servo enabling terminal (SON) or internal servo enabling parameter



(P0.04). See the function description of terminal SON and detailed explanation of parameter P0.04.

When servo enabling:

- ◆ If no alarm occurs, the panel will display the default monitoring parameters;
- ◆ The fan starts to run;
- ◆ In the position, fully close loop mode, if there is no pulse command input, the servo is in locked state;
- ◆ In the speed mode, the servo motor runs at the given speed;
- ◆ In the torque mode, if no torque is applied externally, the servo motor accelerates from zero speed to the limit speed. If the external torque is larger than the internal setting one, the servo motor maintains the state of zero speed output;
- ◆ If a servo alarm occurs, the panel will display ErXX-X and flicker and the servo motor will get into the inertia running state.

### 5.1.8 Coast to Stop/Stop

If the servo drive is in the following conditions, the servo motor will coast to stop or stop normally. Coasting to stop means the drive cuts off output immediately, the motor coasts to stop under the action of inertia, and does not keep in locked state. Stopping means the drive outputs reverse torque to make the motor to decelerate to zero speed and, after that, the motor is in a locked state.

- ◆ When the servo enabling terminal (SON) signal is set to OFF, the servo motor will stop. Select the stopping method through setting parameter P4.30. See description of P4.30 for details. This process will not cause regenerative braking.
- ◆ When a fault alarm occurs, the servo motor will stop. Select the stopping method of the servo motor when an alarm occurs through setting parameter P4.30. See description of P4.30 for details. This process will not cause regenerative braking.
- ◆ When the zero speed clamp terminal (ZRS) signal is set to ON, the servo motor will stop. In the position mode and torque mode, the servo motor will stop immediately. In the speed mode, set parameter P0.58 to select whether the servo motor stops immediately or decelerates to stop according to the settings of parameter P0.56 and P0.57. After stop the servo is in a locked state. This stop process may cause regenerative braking. If a braking overload fault alarm occurs, please install an external braking resistor.
- ◆ If the travel limit terminal signal is valid (parameter P3.40=0), and the travel limit terminal (POT/NOT) signal is set to ON, P0.55 and P0.57 of the servo motor will immediately decelerate to a stop and get into a locked state. After it stops running, if a reverse running command is valid, the motor can run in reverse direction.
- ◆ If the emergency stop terminal signal is invalid (parameter P3.41=0), and the emergency stop terminal (EMG) signal is set to ON, the servo motor will coast to stop.

### 5.1.9 Sequence diagram

#### 5.1.9.1 Sequence diagram of power-on and servo ON

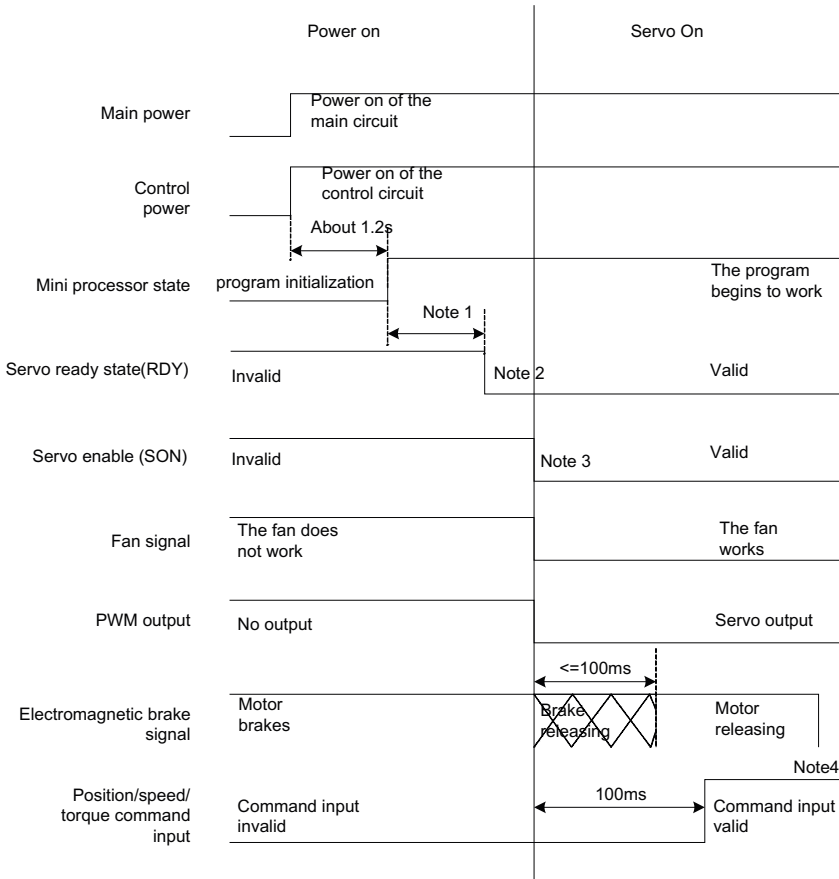

**Note 1:** the delay time from the microprocessor initialization to servo ready output valid can be set by P4.54

**Note 2:** the condition of less level of the servo ready output signal: the servo has no fault or the DC voltage of the main circuit is established (the voltage is higher than 250V/430V)(220V/400V), if the voltage of the main circuit is less than 170V/310V(220V/400V), Er13-1 will be reported and the time from the servo ready to the servo enabling can be controlled.

**Note 3:** only when the servo ready output signal is valid, the servo enable signal is valid

**Note 4:** the actual level corresponding to input/output valid state can be set by P3.00~P3.15

Figure 5-4 Sequence diagram of power-on and servo ON

5.1.9.2 Sequence diagram of power loss during running

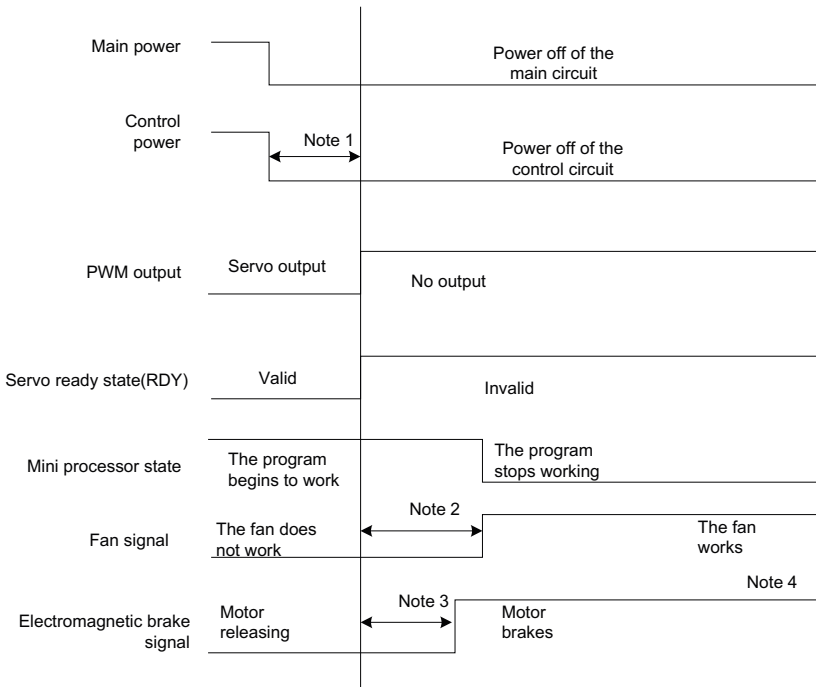

**Note 1:** if the voltage of the main circuit is less than 170V/330V(220V/400V), the undervoltage fault will occur and the output level of the servo fault (ALM) is increasing

**Note 2:** if the drive temperature is less than 45 degrees, the fan stops, if the drive temperature is higher than 45 degrees, the fan will stop after the mini processor stops Note 3: the electromagnetic brake signal is set by P3.57; if the speed is less than the setting value of P3.58 during the time of P3.57, the BRK signal is valid

**Note 4:** the actual level corresponding to input/output valid state can be set by P3.00~P3.15

Figure 5-5 Sequence diagram of power loss during running

5.1.9.3 Servo OFF sequence in a locked state

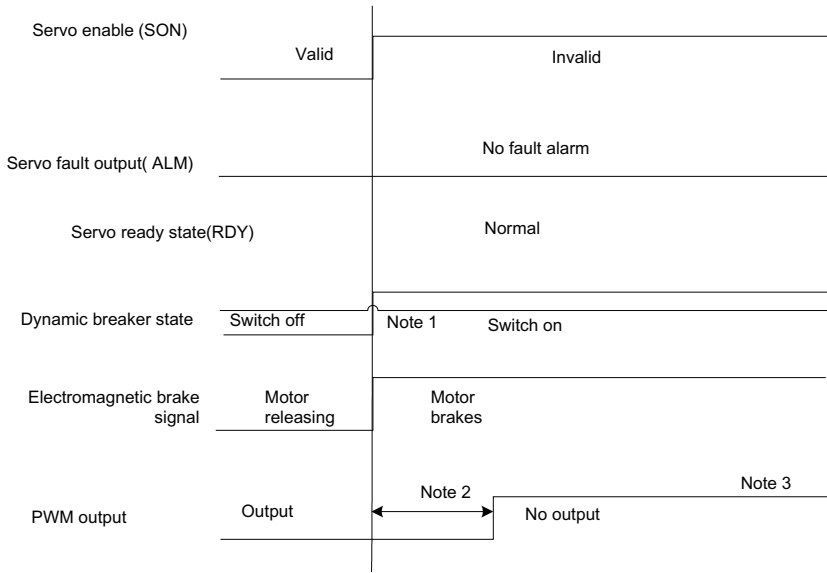

**Note 1: the switch on/off of the dynamic breaker can be controlled by P4.30**

**Note 2: the servo locking time after braking is set by P3.56**

**Note 3: the actual level corresponding to input/output valid state can be set by P3.00~P3.15**

Figure 5-6 Servo OFF sequence diagram in a locked state

5.1.9.4 Servo OFF sequence in running state

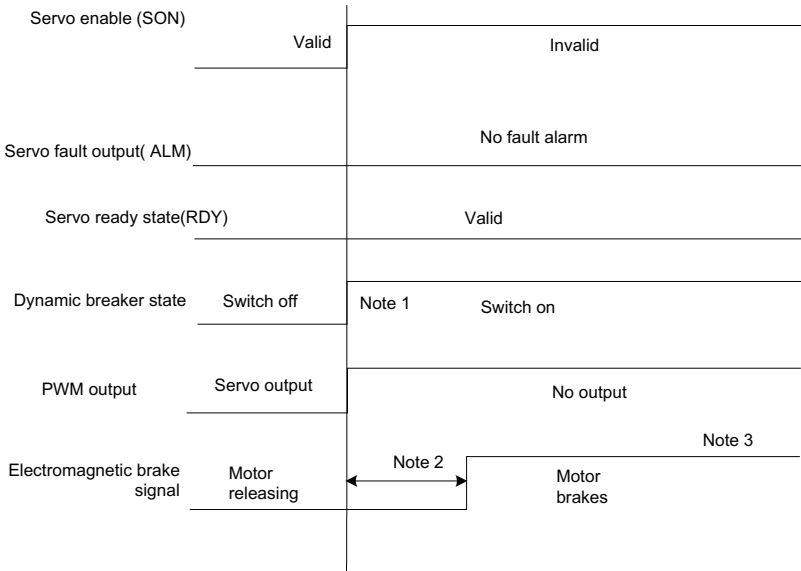

- Note 1:** the switch on/off of the dynamic breaker can be controlled by P4.30
- Note 2:** the electromagnetic brake signal is set by P3.57; if the speed is less than the setting value of P3.58 during the time of P3.57, the BRK signal is valid
- Note 3:** the actual level corresponding to input/output valid state can be set by P3.00~P3.15

Figure 5-7 Servo OFF sequence diagram in running state

5.1.9.5 Sequence of fault alarm

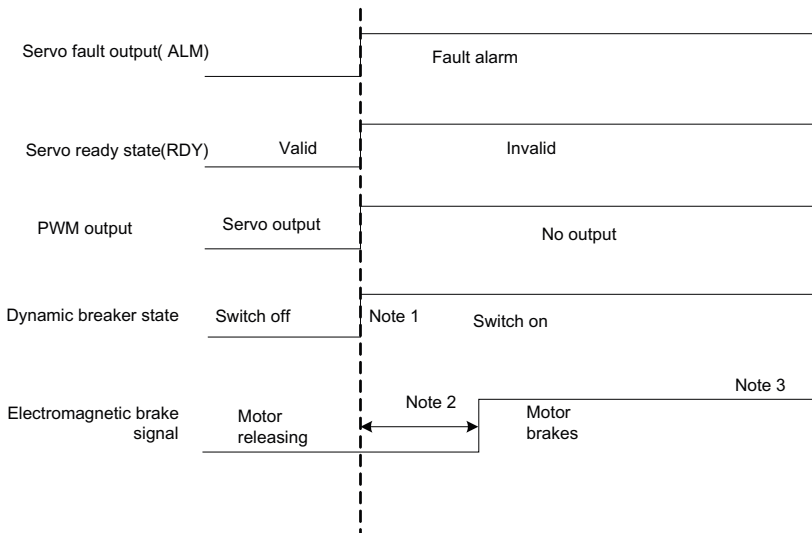

- Note 1:** the switch on/off of the dynamic breaker can be controlled by P4.30
- Note 2:** the electromagnetic brake signal is set by P3.57; if the speed is less than the setting value of P3.58 during the time of P3.57, the BRK signal is valid
- Note 3:** the actual level corresponding to input/output valid state can be set by P3.00~P3.15

Figure 5-8 Sequence diagram of fault alarm

## 5.2 Display and operation

### 5.2.1 Display

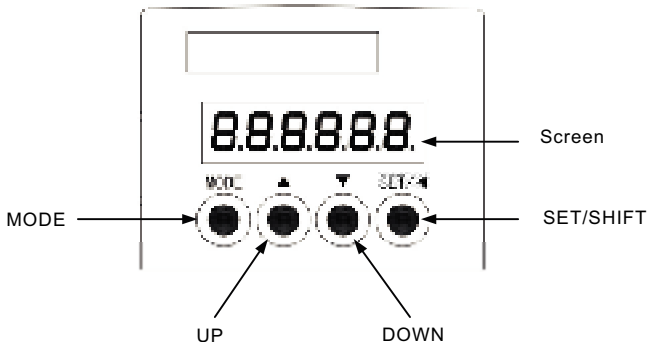

Figure 5-9 Schematic diagram of the keypad

Table 5-1 Buttons definition

Key	Function
<b>MODE</b>	Used to switch between different modes or return to previous menu
<b>UP</b>	Used to select parameter upwards or increase value
<b>DOWN</b>	Used to select parameter downwards or decrease value
<b>SET/SHIFT</b>	Press for a long time =SET (about 0.6 seconds) Used to select parameter downwards or decrease value Press for a short time =SHIFT: When setting a parameter, it is used to select the position of the current digit

Operation flowchart

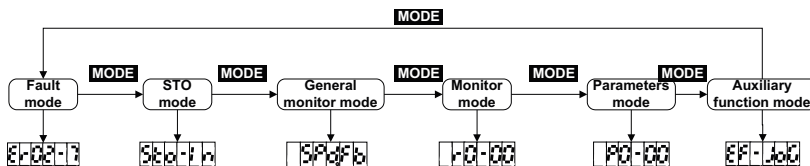

Figure 5-10 Operation flowchart

If the drive is power on, the screen will display **000000** for about 1 second, and then display **888888** for about 1 second, after that, enter into the “General monitoring mode”.

1. Press **MODE** key to switch “General monitoring mode”→“ Monitoring mode”→“Parameters mode”→“ Auxiliary function mode”→“Fault mode”→“STO mode” as a cycle mode. If no fault or no

STO input, the fault mode and STO mode can be ignored.

2. If new fault occurs, it will switch to "Fault mode" by pressing **MODE** key. If no key is pressed in 20 seconds, it will switch to "Fault mode" automatically.
3. In "General monitoring mode", **UP/DOWN** key can be used to switch monitoring parameters. The name of parameters will display for 2.5 seconds, and then the current value will be displayed.
4. In parameters mode, **SHIFT** key can be used to switch the group number and **UP/DOWN** key can be used to select the internal parameters number.
5. In the parameters setting mode, pressing **SHIFT** to make the flickering words move left and use the **UP/DOWN** key to modify the setting value of the high bit.
6. After parameters setting, pressing **SET** key to save the parameters or execute the commands.
7. After parameters setting, the screen will display "SAVED" or "SUCCES" and then return to the parameters mode automatically.

### 5.2.2 State monitoring mode

After power on, the screen will enter into "General monitoring mode", display the parameters name for about 2.5 seconds and then display the current value. After pressing **MODE** key, **UP/DOWN** key can be used to switch monitoring parameters. If no operation, it will return to the monitoring interface in 20 seconds.

Operation flowchart

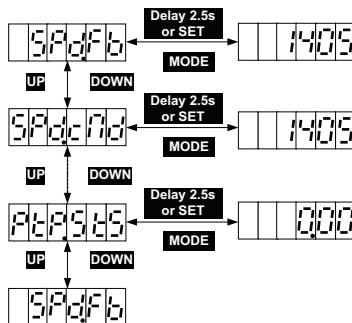

Figure 5-11 Operation flowchart

### 5.2.3 Monitoring mode

**MODE** key can be used to switch into the monitoring mode. **SHIFT** key can be used to select the group number of the monitoring parameters, **UP/DOWN** can be used to select the internal parameter number and pressing for a long time, it can be used to select the parameter number quickly. After finding the target, **SET** key can be used to view the current value and **MODE** can be used to return the displaying interface. If no operation in R3 menu interface, it will return to the monitoring interface in 20 seconds. If no operation in R0 and R1 menu interface, it will stay on the displaying interface.



Operation flowchart

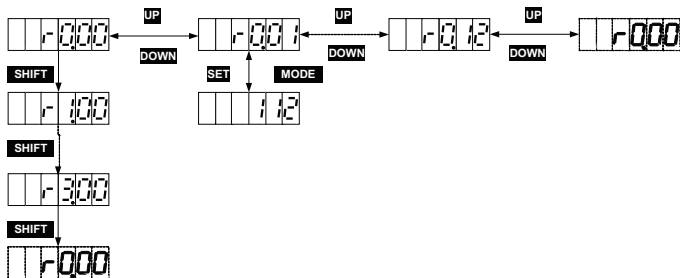

Figure 5-12 Operation flowchart

### 5.2.4 Parameter setting

**MODE** key can be used to switch into the parameters setting mode. **SHIFT** key can be used to select the group number of the monitoring parameters, **UP/DOWN** can be used to select the internal parameter number and pressing for a long time, it can be used to select the parameter number quickly. After finding the target, **SET** key can be used to view the current value and **SHIFT** key to the parameters setting. In the setting interface, **UP/DOWN** key can be used to set the value, **SHIFT** key can be used to select the setting bit. After setting, press **SET** key to save the parameters. After finishing, the screen will display “SAVED” or “SECCUS”, and then return to the parameters mode automatically.

Operation flowchart

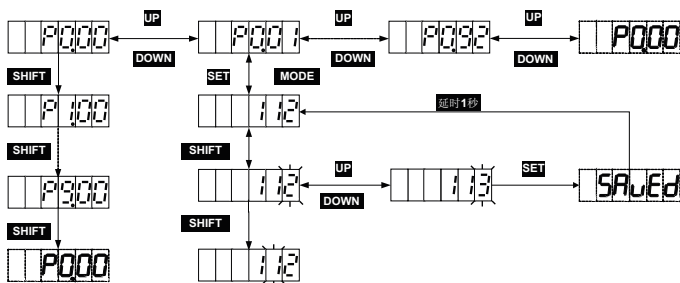

Figure 5-13 Operation flowchart

### 5.2.5 Auxiliary functions

#### 5.2.5.1 Auxiliary function menu

Press **MODE** to the auxiliary mode and press **UP/DOWN** to select the functions.

**Note:** All auxiliary functions are available when the servo is disabled.

Table 5-5 Auxiliary function

Sign	Name
EF-JOG	Jogging test
EF-dPF	Restore the factory parameter
EF-PJb	Program commissioning
EF-PA1	Analog speed reference zero drift clear
EF-PA2	Analog torque reference zero drift clear
EF-PA3	Analog input 3 zero drift clear
EF-JId	Inertia identification
EF-Enc	The absolute value of encoder reset

5.2.5.2 Operation flowchart of jogging

Press **MODE** key to the auxiliary function mode. Press **UP/DOWN** key to the EF-JOG menu, and press **SET** key to the jogging interface. The interface will display the current speed of the motor. Press **UP** key, the motor will rotate to the setting speed anticlockwise and stops when releasing the key. Press **DOWN** key, the motor will rotate to the setting speed clockwise and stops when releasing the key.

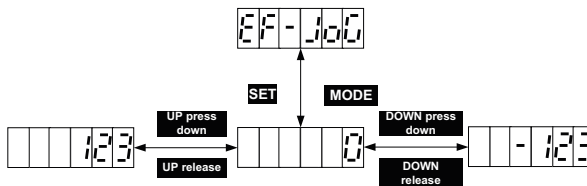

Figure 5-14 Operation flowchart

5.2.5.3 Operation flowchart of restoring the factory parameter

Press **MODE** key to the auxiliary function mode. Press **UP/DOWN** key to the EF-dPF menu, and press **SET** key to the interface. The interface will display **READY**. Press **SET** key to restore to the factory values, it will display **START**, after finishing, it will display **Finish**. The Operation flowchart of analog speed reference zero drift clear, analog torque reference zero drift clear and analog torque reference zero drift clear are the same.

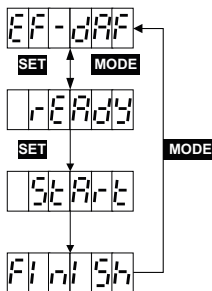

Figure 5-15 Operation flowchart

**5.2.5.4 Operation flowchart of program commissioning**

Press **MODE** key to the auxiliary function mode. Press **UP/DOWN** key to the `EF-PJd` menu, and press **SET** key to the interface. The interface will display `rEAdy`. In the interface of `rEAdy`, **SHIFT** key can be used to switch between `rEAdy` and `on`, start and stop the commissioning function. In the interface of `on`, **UP/DOWN** key can be used to start the program commissioning and has no relationship with P5.00. If the motor direction is counterclockwise, it can be started by **UP** key. If the motor direction is clockwise, it can be started by **DOWN** key. After starting, the interface will display the current speed.

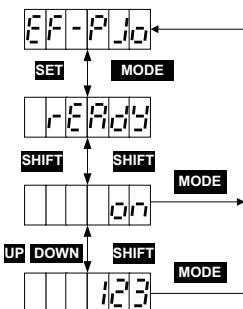

Figure 5-16 Operation flowchart

**5.2.5.5 Operation flowchart of inertia identification**

Press **MODE** key to the auxiliary function mode. Press **UP/DOWN** key to the `EF-JId` menu, and press **SET** key to the interface. The interface will display `rEAdy`. Press **SET** key to start the inertia identification. After finishing, the result `23` will be displayed for about 3 seconds and saved automatically. It will return to eh parameters after displaying `SrVEd` for about 2 seconds.

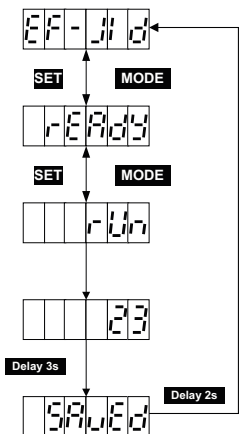

Figure 5-17 Operation flowchart

### 5.2.5.6 Operation flowchart of encoder resetting

If the multiple circle encoders are used, the zeroing of mechanical system is needed after first power on. Press **MODE** key to the auxiliary function mode. Press **UP/DOWN** key to the `EF-Enc` menu, and press **SET** key to the interface. The interface will display `rEAdy`. Press **SET** key to start the clearing, the interface will display `StArT`, and after finishing, it will display `FinIsh`; if the encoder model is not matched or the operation is failed, it will display `ErRor`.

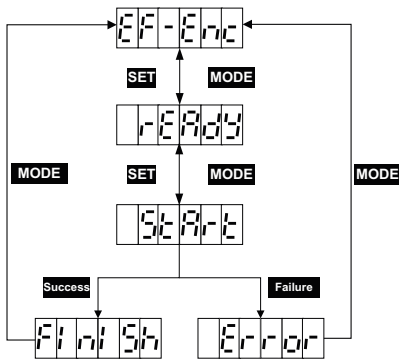

Figure 5-18 Operation flowchart

### 5.2.6 Alarm display

When the servo drive runs abnormally, it will perform fault alarm or warning protection. At this time the panel will display the fault alarm or warning identifier. The format is ErXX-X, of which, XX is the master code and X is the sub code.

Please refer to appendix 10.4 for the meanings of the alarm or warning identifiers.

### **5.2.7 Alarm clearance**

For fault alarms, if the fault condition is removed, the fault alarm display can be removed by short connecting the alarm clear terminal CLA with COM-. If the servo is still in enabled state at this time, the drive will recover running automatically.

For the fault alarms which can not be cleared online, it can be cleared after repower on.

# Detailed parameter description

# 6

P-position mode; S-speed mode; T-torque mode;F-fully close loop mode.

The definition of direction: in line with the direction of motor shaft, the counter clockwise direction which is short for CW is the forward direction; the clockwise direction which is short for CCW is the reverse direction. For the speed and torque reference, the positive value is the forward direction and the negative value is the reverse direction.

The function codes with the superscript of "1" indicate that these parameters can be valid only when the system is reset and restarted or repowered after disconnection.

The function codes with the superscript of "2" indicate that these parameters are valid when the servo drive stops. The modification during operation is invalid. The function codes with the superscript of "\*" indicate that these parameters are not saved after power off.

Modbus communication address is binary, the address of PROFIBUS-DP is the same as Modbus CANopen communication address is hex and the length of 16bit is the primary code and the length of 8bit is the subcode.

## 6.1 Basic parameters (P0 group parameters)

### 6.1.1 Basic control

	P0.00 <sup>1</sup>	Motor model	Setting range	Default	Unit	Available mode			
			0~9999	2300 <sup>*1</sup>	-	P	S	T	F

The parameter is standard motor model by default. Users must set the parameter according to the name plate of the motor.

For example, the name plate of 400W motor is: of which, No.: 2300 is the set value of the parameter.

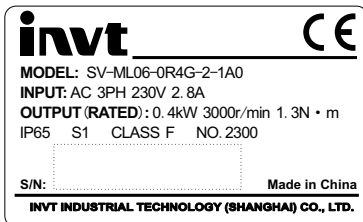

**Note:** Setting the parameter incorrectly will cause abnormal running of the servo system and even serious fault of the drive and motor.

<sup>\*1</sup> Different drive models are fitted with different default motor models as standard, 2300-corresponding default motor model of 400W drive; as for the motor mounted with communication encoder, the motor model is read by encoder EEPROM automatically.

P0.00 <sup>1</sup>	Data	16bit	Data format	DEC
	Modbus communication address	1000, 1001	CANopen communication address	0x2000, 0x00

P0.01 <sup>1</sup>	Encoder type	Setting range	Default	Unit	Available mode			
		1~8	4* <sup>1</sup>	-	P	S	T	F

When the drive powers on, automatically identify the type of connected encoder. If not reporting Er-02-0 (encoder offline fault), the parameter will display the actual type of connected encoder.

In the case that the encoder is connected properly, if reporting encoder offline fault when power on, please check whether the drive supports the encoder type. See **Chapter 1.1.3 Naming of the drive**.

For example. The name plate of 400W motor is:

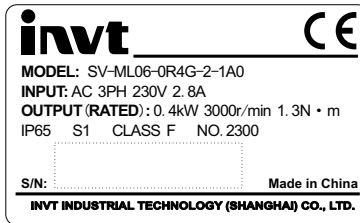

Of which, 1 in 1A0 of SV-ML06-0R4G-2-1A0 is the setting value of this parameter.

Setting value	Meaning
1	2500-wire standard incremental
2	2500-wire multiplexed data line incremental
3	17-bit single circle absolute value
<b>【4】</b>	17-bit multiple circles absolute value * <sup>2</sup>
5	20-bit single circle absolute value
6	20-bit multiple circles absolute value * <sup>2</sup>
7	12-bit rotary transformer
8	16-bit rotary transformer

\*<sup>1</sup>: This parameter can identify the matching encoder for the motors after power on and the displayed content can be modified automatically. If the drive is disconnected with the motor, the parameter can be modified and saved.

\*<sup>2</sup>: When the multiple-circle encoders are used, it is necessary to change the battery when the drive is power on. The standard battery is 2000mAh and the replacing cycle is 1.5~2 years.

P0.01 <sup>1</sup>	Data	16bit	Data format	DEC
	Modbus communication address	1002,1003	CANopen communication address	0x2001, 0x00

P0.03 <sup>1</sup>	Control mode	Setting range	Default	Unit	Available mode			
		0~9	0	-	P	S	T	F

This parameter can be used to set the operating mode of the system:

Setting value	1 <sup>st</sup> working mode	2 <sup>nd</sup> working mode	Instruction
0	P	/	Position mode: In the position mode, it can control the angular displacement of the servo motor with the pulse command and thus achieve the goal to control the displacement of the mechanical movement.
1	S	/	Speed mode: The mode can control the rotation speed of the servo motor with the internal speed command or external analog speed command
2	T	/	Torque mode: The mode can control the output torque of the servo motor with the internal torque command or external analog torque command.
3	P	S	Position/speed mode: The position mode and speed mode can be switched with the control mode switching terminal. 
			<p><b>Note:</b> When the position mode is switched to speed mode, it can be selected by P0.92;</p>



			when the speed mode is switched into position mode, the motor will stop at the reference position of P0.91, and then to switch.
4	/	T	<p>Position/torque mode: The position mode and torque mode can be switched with the control mode switching terminal</p> <p><b>Note:</b> When the position mode is switched to torque mode, it can be selected by P0.92; when the torque mode is switched into position mode, the motor will stop at the reference position of P0.91, and then to switch.</p>
5	S	T	<p>Speed/torque mode: The speed mode and torque mode can be switched with control mode switching terminal</p> <p><b>Note:</b> The switching mode is not limited by the actual operation.</p>
6	F	/	Fully closed loop mode: Use the grating ruler to detect the devices of control object and conduct information feedback position control.
7	CANopen	/	

8	EtherCAT	/	
9	MotionNet	/	

Remark:

Select one P3.00~P3.09 to the control mode switching (0x005 or 0x105),

MCH terminal state	Current working mode
Invalid(0)	1 <sup>st</sup> working mode
Valid(1)	2 <sup>nd</sup> working mode

**Note:**

0:OFF (the terminal is disconnected with COM-);

1:ON (the terminal is connected with COM-).

P0.03 <sup>1</sup>	Data	16bit	Data format	DEC
	Modbus communication address	1006,1007	CANopen communication address	0x2003, 0x00

P0.04*	Internal enabling command	Setting range	Default	Unit	Available mode			
		0~1	0	-	P	S	T	F

This parameter is used to control the operation state of the servo drive:

Setting value	External terminal command state	Working state of the servo drive
0	0 (the terminal is disconnected with COM-)	Stand-by (OFF)
0	1 (the terminal is connected with COM-)	Enabling running (ON)
1	0 (the terminal is disconnected with COM-)	Enabling running (ON)
1	1 (the terminal is connected with COM-)	Enabling running (ON)

**Note:** 1. When P0.04 is 1and the external terminal command is from 1 to 0, the servo drive is disabled.

2. When this parameter is operated by the LED panel, it can only be switched by 0 and 1 of **SET** key and **UP/DOWN** key is invalid.

**Warning:** If the servo drive is controlled by the external, please ensure there is no system fault and disconnect the terminal with COM-.

P0.04*	Data	16bit	Data format	DEC
	Modbus communication address	1008,1009	CANopen communication address	0x2004, 0x00

P0.05	Jog speed(JOG)	Setting range	Default	Unit	Available mode			
		0~1000.0	200.0	r/min	P	S	T	F

This parameter can be used to set the jog speed. For jogging, please refer to chapter 5.1.4. During jogging, the ACC/DEC time parameters (P0.54, P0.56, P0.55, and P0.57) are active. The motor will accelerate, decelerate, start and stop according to the settings.

P0.05	Data	16bit	Data format	DEC
	Modbus communication address	1010,1011	CANopen communication address	0x2005, 0x00

P0.06 <sup>1</sup>	Numerator of the frequency division coefficient of encoder pulse output	Setting range	Default	Unit	Available mode			
		0~(2 <sup>31</sup> -1)	10000	-	P	S	T	F
P0.07 <sup>1</sup>	Denominator of the frequency division coefficient of encoder pulse output	Setting range	Default	Unit	Available mode			
		1~(2 <sup>31</sup> -1)	131072	-	P	S	T	F

**Detailed instruction:**

By setting the numerator and denominator of the frequency division coefficient of encoder pulse output, the signal of the encoder can be frequency divided by any integer or decimal fraction and then outputted through the encoder's pulse output signal terminals(OA+, OA-, OB+ and OB- pin "44""43""41" and "42")

$$\text{Output pulse number of the drive} = \frac{P0.06}{P0.07} \times \text{Resolution of the encoder}$$

**Note:**

1. In the position control mode, if the encoder output signal of the preceding stage servo motor is used as the position pulse command input of the succeeding stage servo drive, i.e. as start/stop type master-slave follow-up, in order to ensure high positioning accuracy of the succeeding stage servo drive, the frequency division coefficient must be 1:1. Otherwise the accuracy of master-slave position follow-up will be affected in this case.

2. In factory setting, P0.07 is 131072, P0.06 is 10000, which means the output terminal of the encoder will output 1000 pulse signal when the motor rotates a circle. If P0.06 is 5000, the output terminal of the encoder will output 1000 pulse signal.

P0.06 <sup>1</sup>	Data	32bit	Data format	DEC
	Modbus communication address	1012,1013	CANopen communication address	0x2006, 0x00
P0.07 <sup>1</sup>	Data	32bit	Data format	DEC
	Modbus communication address	1014,1015	CANopen communication address	0x2007, 0x00

P0.08 <sup>1</sup>	Logic reverse of pulse output	Setting range	Default	Unit	Available mode			
		0~1	0	-	P	S	T	F

The reverse of B phase can be carried out through this parameter and the relationship between A phase and B phase can be changed:

Setting value	Logic of B phase	CCW	CW
【0】	Non-reverse		
1	Reverse		

P0.08 <sup>1</sup>	Data	16bit	Data format	DEC
	Modbus communication address	1016,1017	CANopen communication address	0x2008, 0x00

P0.09	Torque limit mode	Setting range	Default	Unit	Available mode			
		0~6	1	-	P	S		F

This parameter is used to set the torque limit mode.

In speed mode, the analog input 3 is set to the torque limit, and:

Setting value	Forward direction	Reverse direction
0	Analog input 3(0V~10V)	Analog torque command (-10V~0V)
<b>【 1 】</b>	Max. torque limit 1(P0.10)	
2	Max. torque limit 1(P0.10)	Max. torque limit 2(P0.11)
3	TLC OFF → Max. torque limit 1(P0.10) TLC ON → Max. torque limit 2(P0.11)	
4	Analog input 3(0V~10V)	Analog torque command (0V~10V)
5	Analog input 3(0~10V)	
6	Analog torque command (0V~10V)	

If the analog input 3 is the speed input, the meaning of the parameter is as below:

Setting value	Forward direction	Reverse direction
0	0	Analog torque command (-10V~0V)
<b>【 1 】</b>	Max. torque limit 1(P0.10)	
2	Max. torque limit 1(P0.10)	Max. torque limit 2(P0.11)
3	TLC OFF → Max. torque limit 1(P0.10) TLC ON → Max. torque limit 2(P0.11)	
4	0	Analog torque command (0V~10V)
5	0	
6	Analog torque command (0V~10V)	

**Note:** If P0.09 is 3, the torque switching is not valid instantly and limited by P4.51 and P4.52, the detailed information is as the figure below:

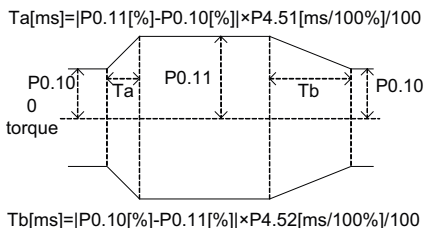

P0.09	Data	16bit	Data format	DEC
-------	------	-------	-------------	-----

	Modbus communication address	1018,1019	CANopen communication address	0x2009, 0x00
--	------------------------------	-----------	-------------------------------	--------------

P0.10	Max torque limit 1	Setting range	Default	Unit	Available mode			
		0~500.0	300.0	%	P	S	T	F
P0.11	Max torque limit 2	Setting range	Default	Unit	Available mode			
		0~500.0	300.0	%	P	S		F

These parameters can be used to set the maximum torque of the servo motor output. Taking the rated torque of the servo motor as 100%, the setting is the percentage of the rated torque of the servo motor. If the absolute value of the torque command is larger than the value of this parameter, then the actual output torque will be limited by the parameter.

**Note:**

1. These parameters are used with P0.09;
2. In torque mode, the limit value is determined by P0.10.

P0.10	Data	16bit	Data format	DEC
	Modbus communication address	1020,1021	CANopen communication address	0x200A, 0x00
P0.11	Data	16bit	Data format	DEC
	Modbus communication address	1022,1023	CANopen communication address	0x200B, 0x00

P0.13 <sup>1</sup>	Power of the external braking resistor	Setting range	Default	Unit	Available mode			
		0~5000	200	W	P	S	T	F
P0.14 <sup>1</sup>	Resistance of the external braking resistor	Setting range	Default	Unit	Available mode			
		1~1000	60	Ω	P	S	T	F

When an external braking resistor is connected, this group of parameters should be set with the values equal to the resistance and power of the external braking resistor. Please set this group of parameters correctly. Otherwise if the values of this group of parameters are not matched with

the parameters of the external braking resistor, it may report a braking overload fault (Er07-0) by mistake or cause burnout of the braking resistor. The regenerative braking overload protection time is proportional to these two parameters. When P4.34 is other value, these parameters are invalid.

P0.13 <sup>1</sup>	Data	16bit	Data format	DEC
	Modbus communication address	1026,1027	CANopen communication address	0x200D, 0x00
P0.14 <sup>1</sup>	Data	16bit	Data format	DEC
	Modbus communication address	1028,1029	CANopen communication address	0x200E, 0x00

P0.15	Default monitoring parameters	Setting range	Default	Unit	Available mode			
		0~22	0	-	P	S	T	F

This parameter is used to set the parameters which can be monitored while powering-on of the system:

Setting value	Parameter meaning	Sign	Unit
<b>【0】</b>	Motor rotation speed	SPdFb	r/min
1	Speed command	SPdcNd	r/min
2	Pulse feedback accumulation	PLSFb	pulse
3	Pulse command accumulation	PLScNd	pulse
4	Stranded pulse	PLSEr1	pulse
5	Hybrid control deviation	PLSEr2	pulse
6	Current torque	Er9Fb	%
7	Main circuit DC voltage	UbUS1	V
8	Control power supply voltage	UbUS2	V
9	Output voltage	UoUt	Vrms
10	Output current	I.oUt	Arms
11	Drive temperature	NdLEnP	°C
12	Torque limit	Er9LNE	%
11	Encoder feedback	EncFb	pulse
14	Rotor position to Z pulse	EncAbS	pulse

	15	Load inertia ratio	<input type="text" value="0000"/> <input type="text" value="J-r"/>	%
	16	Output power	<input type="text" value="0000"/> <input type="text" value="PdBEr"/>	%
	17	Motor load rate	<input type="text" value="0000"/> <input type="text" value="LoPd-r"/>	%
	18	Molecule of actual electronic gear	<input type="text" value="0000"/> <input type="text" value="nUN"/>	-
	19	Denominator of actual electronic gear	<input type="text" value="0000"/> <input type="text" value="dEN"/>	-
	20	Pulse speed command	<input type="text" value="0000"/> <input type="text" value="PLSSpD"/>	r/min
	21	Instant speed	<input type="text" value="0000"/> <input type="text" value="SPdFbI"/>	r/min
	22	Bit state	<input type="text" value="0000"/> <input type="text" value="PLPSEtS"/>	-
P0.15	Data	16bit	Data format	DEC
	Modbus communication address	1030,1031	CANopen communication address	0x200F, 0x00

P0.16	Parameter modification operation locking	Setting range	Default	Unit	Available mode													
		0~1	0	-	P	S	T	F										
<p>This parameter is used to mask the parameter setting function and thus to avoid incorrect modification of the parameters by the user.:</p> <table border="1" style="width: 100%;"> <tr> <th>Setting value</th> <th>Operation</th> <th>Communication operation</th> </tr> <tr> <td>【0】</td> <td>Parameter modification valid</td> <td>Parameter modification valid</td> </tr> <tr> <td></td> <td>Parameter modification invalid</td> <td>Parameter modification valid</td> </tr> </table>										Setting value	Operation	Communication operation	【0】	Parameter modification valid	Parameter modification valid		Parameter modification invalid	Parameter modification valid
Setting value	Operation	Communication operation																
【0】	Parameter modification valid	Parameter modification valid																
	Parameter modification invalid	Parameter modification valid																
P0.16	Data	16bit	Data format	DEC														
	Modbus communication address	1032,1033	CANopen communication address	0x2010, 0x00														

P0.17	EEPROM write mode	Setting range	Default	Unit	Available mode			
		0~1	0	-	P	S	T	F



This parameter is used to set the EEPROM write mode				
	Setting value	Command pulse input		
	<b>【0】</b>	Saved one by one(automatic saved after modification)		
	1	Bulk storage(be saved by P4.91 after modification)		
P0.17	Data	16bit	Data format	DEC
	Modbus communication address	1034,1035	CANopen communication address	0x2011, 0x00

	P0.18*	Factory password	Setting range	Default	Unit	Available mode				
			0~1	0	-	P	S	T	F	
This parameter is used to view and modify the menu.										
P0.18*	Data	16bit	Data format	DEC						
	Modbus communication address	1036,1037	CANopen communication address	0x2012, 0x00						

**6.1.2 Position control**

	P0.20 <sup>1</sup>	Position command	Setting range	Default	Unit	Available mode				
			0~3	0	-	P			F	
This parameter is used to select the position command source.										
	Setting value	Position command source								
	<b>【0】</b>	Pulse input								
	1	Communication bus input								
	2	Point to point control (PTP)								
	3	Factory use								
P0.20 <sup>1</sup>	Data	16bit	Data format	DEC						
	Modbus communication address	1040,1041	CANopen communication address	0x2014, 0x00						

	P0.22 <sup>1</sup>	Pulse number of a circle motor rotation	Setting range	Default	Unit	Available mode		
			0~1048576	10000	pulse	P		
<p>This parameter is used to set the needed pulse number when the motor rotates a circle.</p> <p><b>Note:</b> P0.22 is set as a non-zero value, the setting of P0.25~P0.29 is invalid. If 17-bit and 20-bit encoder is used, the more pulse number can be set for the requirement.</p>								
P0.22 <sup>1</sup>	Data	32bit	Data format	DEC				
	Modbus communication address	1044,1045	CANopen communication address	0x2016, 0x00				

	P0.23 <sup>1</sup>	Pulse input form	Setting range	Default	Unit	Available mode													
			0~2	0	-	P			F										
<p>This parameter is used to set the manner of pulse input. There are 3 types of pulse input manners:</p>																			
Setting value	Pulse input form	Signal form	Shown in the picture																
			CCW	CW															
			<table border="1"> <tr> <td>【0】</td> <td>Pulse + sign</td> <td>Pulse+ Sign</td> <td></td> <td></td> </tr> <tr> <td>1</td> <td>FWD/REV pulse train</td> <td>CW+CCW</td> <td></td> <td></td> </tr> <tr> <td>2</td> <td>Orthogonal encoder pulse</td> <td>QEP</td> <td></td> <td></td> </tr> </table>	【0】	Pulse + sign	Pulse+ Sign			1	FWD/REV pulse train	CW+CCW			2	Orthogonal encoder pulse	QEP			
【0】	Pulse + sign	Pulse+ Sign																	
1	FWD/REV pulse train	CW+CCW																	
2	Orthogonal encoder pulse	QEP																	

**Remark:** The pulse direction of the parameter can be reversed by P0.24<sup>1</sup>. Please refer to P0.24<sup>1</sup> for detailed information.

P0.23 <sup>1</sup>	Data	16bit	Data format	DEC				
	Modbus communication address	1046,1047	CANopen communication address	0x2017, 0x00				

	P0.24 <sup>1</sup>	Pulse input direction	Setting	Default	Unit	Available mode		
--	--------------------	-----------------------	---------	---------	------	----------------	--	--

	reversing	range												
		0~1	0	-	P			F						
<p>By setting this parameter, the direction of the input pulse can be reversed. At this time the actual output speed direction of the servo drive is opposite to the direction indicated by the pulse input form in P0.23.</p> <table border="1" style="width: 100%; border-collapse: collapse;"> <tr> <th style="width: 15%;">Setting value</th> <th>Pulse input</th> </tr> <tr> <td style="text-align: center;">【0】</td> <td>Pulse input direction does not change</td> </tr> <tr> <td style="text-align: center;">1</td> <td>Pulse input direction is opposite to the original input direction</td> </tr> </table>									Setting value	Pulse input	【0】	Pulse input direction does not change	1	Pulse input direction is opposite to the original input direction
Setting value	Pulse input													
【0】	Pulse input direction does not change													
1	Pulse input direction is opposite to the original input direction													
P0.24 <sup>1</sup>	Data	16bit	Data format	DEC										
	Modbus communication address	1048,1049	CANopen communication address	0x2018, 0x00										

P0.25	Numerator of the 1 <sup>st</sup> electronic gear	Setting range	Default	Unit	Available mode			
		0~(2 <sup>31</sup> -1)	0	-	P			F
P0.26 <sup>2</sup>	Denominator of the electronic gear	Setting range	Default	Unit	Available mode			
		1~(2 <sup>31</sup> -1)	10000	-	P			F
P0.27	Numerator of the 2 <sup>nd</sup> electronic gear	Setting range	Default	Unit	Available mode			
		0~(2 <sup>31</sup> -1)	0	-	P			F
P0.28	Numerator of the 3 <sup>rd</sup> electronic gear	Setting range	Default	Unit	Available mode			
		0~(2 <sup>31</sup> -1)	0	-	P			F
P0.29	Numerator of the 4 <sup>th</sup> electronic gear	Setting range	Default	Unit	Available mode			
		0~(2 <sup>31</sup> -1)	0	-	P			F

Concept of the electronic gears: for discretionary pulse input, the number and frequency of the pulse actually received by the drive can be changed by multiplying a certain coefficient. It can be shown separately with two parts: numerator and denominator:

$$\text{Electronic gear} = \frac{g^1}{g^2}$$

Of which

$g^1$  :The numerator of the electronic gear;

$g^2$  : The denominator of the electronic gear;

Below is the schematic diagram of the electronic gear in the system:

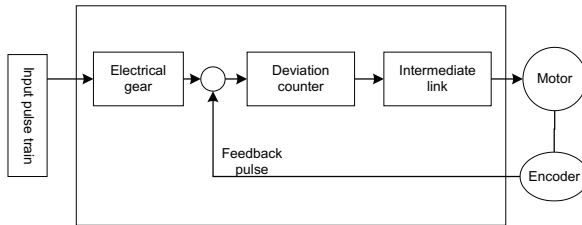

**Example:**

Below is a case where 1 pulse is equivalent to a feed rate of  $10 \mu m$

Mechanical specifications:

Feed of the ball screw  $Pb = 10mm$ ;

Reduction ratio  $n = 3/5$ ;

Resolution of the servo motor encoder = 10000;

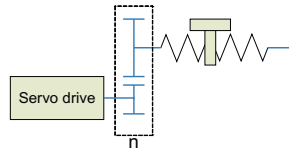

At this time calculate the electronic gear:

$$\frac{g1}{g2} = \Delta l_0 \cdot \frac{Pt}{\Delta S} = \Delta l_0 \cdot \frac{Pt}{n \cdot Pb} = 10 \times 10^{-3} \cdot \frac{10000}{(3/5) \cdot 10} = \frac{50}{3}$$

In the formula :

$\Delta l_0$  : Feed rate corresponding to per pulse (mm/pulse);

$\Delta S$  : Feed rate corresponding to per revolution of the motor (mm/rev).

i.e. in this example,  $g1 = 50$ ,  $g2 = 3$ .

Set P0.25 to 50 and P0.26 to 3.

The servo drive has 4 groups of electric gear: P0.25, P0.26, P0.27, P0.28, P0.29 can be selected to be output through the combination of SC1, SC2:

SC1	SC2	Position mode/Fully close loop mode
0	0	Numerator of the 1 <sup>st</sup> electronic gear ratio
1	0	Numerator of the 2 <sup>nd</sup> electronic gear ratio
0	1	Numerator of the 3 <sup>rd</sup> electronic gear ratio
1	1	Position mode/Fully close loop mode

**Note:** The parameters are valid when P0.22<sup>1</sup> is 0.

	Data	32bit	Data format	DEC
P0.25	Modbus communication address	1050,1051	CANopen communication address	0x2019, 0x00

P0.26 <sup>2</sup>	Data	32bit	Data format	DEC
	Modbus communication address	1052,1053	CANopen communication address	0x201A, 0x00
P0.27	Data	32bit	Data format	DEC
	Modbus communication address	1054,1055	CANopen communication address	0x201B, 0x00
P0.28	Data	32bit	Data format	DEC
	Modbus communication address	1056,1057	CANopen communication address	0x201C, 0x00
P0.29	Data	32bit	Data format	DEC
	Modbus communication address	1058,1059	CANopen communication address	0x201D, 0x00

P0.33 <sup>2</sup>	Smooth filter of position command	Setting range	Default	Unit	Available mode		
		0.0~1000.0	0.0	ms	P		F

This parameter is used to set the time constant of the low pass filter of the corresponding position and reduce the mechanical shock when the input pulse commands frequency changes. It is shown as the figure below:

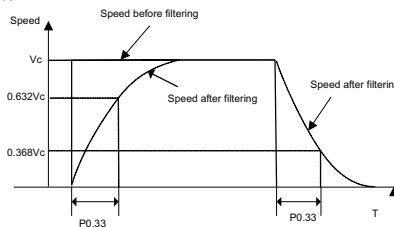

P0.33 <sup>2</sup>	Data	16bit	Data format	DEC
	Modbus communication address	1066,1067	CANopen communication address	0x2021, 0x00

P0.34 <sup>2</sup>	FIR filter of position	Setting	Default	Unit	Available mode
--------------------	------------------------	---------	---------	------	----------------

					speed 4
		1	0	0	P0.50 Internal speed 5
		1	0	1	P0.51 Internal speed 6
		1	1	0	P0.52 Internal speed 7
		1	1	1	P0.53 Internal speed 8
Please refer to the detailed instruction of P0.46~P0.53.					
<b>【1】</b>	Analog input	<p>The motor speed can be controlled by the -10V~10V voltage between the analog speed input terminals (AD1, GND, pin "1" and "5") of CN1. In the factory default, the positive value means the forward direction and the negative value means the reverse direction.</p> <p>The direction can be changed by P0.41.</p> <p>Please refer to the detailed instruction of P0.41.</p>			
2	Bus input	<p>The speed command from upper PC can be received by the interface of communication bus. When P4.10 is 1, the motor speed can be changed by P4.13.</p> <p>Please refer to the detailed instruction of P4.10 and P4.13.</p>			
3	Factory use	-			
P0.40	Data	16bit		Data format	DEC
	Modbus communication address	1080,1081		CANopen communication address	0x2028, 0x00

P0.41	Setting of speed command	Setting range	Default	Unit	Available mode		
	direction	0~1	0	-		S	

	command	range					
		0.0~1000.0	0.0	ms	P		F

This parameter is used to set the time constant of the FIR filter of the corresponding position and reduce the mechanical shock when the input pulse commands frequency changes. It is shown as the figure below:

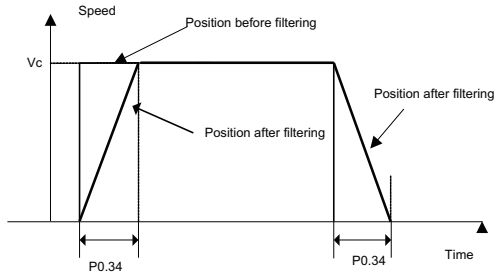

**Note:** If the parameter is modified during the operation, it will be valid after stopping.

P0.34 <sup>2</sup>	Data	16bit	Data format	DEC
	Modbus communication address	1068,1069	CANopen communication address	0x2022, 0x00

P0.35	Software limit of the forward position control	Setting range	Default	Unit	Available mode		
		$-(2^{31}-1)\sim(2^{31}-1)$	0	pulse	P		F

This parameter is used to set the software limit of the forward position control.

**Note:** The function is valid when it is above P0.36.

P0.35	Data	32bit	Data format	DEC
	Modbus communication address	1070,1071	CANopen communication address	0x2023, 0x00

P0.36	Software limit of the reverse position control	Setting range	Default	Unit	Available mode		
		$-(2^{31}-1)\sim(2^{31}-1)$	0	ms	P		F

This parameter is used to set the software limit of the reverse position control.

**Note:** The function is valid when it is less than P0.35.

P0.36	Data	32bit	Data format	DEC
	Modbus communication address	1072,1073	CANopen communication address	0x2024, 0x00

	address		address	
--	---------	--	---------	--

P0.37	Position command mode	Setting range	Default	Unit	Available mode		
		0~1	0	-	P		F

This parameter is used to set the position command mode when P0.20 is set to be 1 and it is invalid for other modes.

Setting value	Position command mode
【0】	Incremental(the position command input is the variation relative to the current position)
1	Absolute(the position command input is the target position)

P0.37	Data	16bit	Data format	DEC
	Modbus communication address	1074,1075	CANopen communication address	0x2025, 0x00

### 6.1.3 Speed and torque control

P0.40	Speed command	Setting range	Default	Unit	Available mode		
		0~3	1	-	S		

This parameter is used to select the command source of the speed control:

Setting value	Input mode	Instruction				
0	Internal speed step	P3.00~P3.09 can be selected to control the internal multi-step speed (SPD1 is 0x00A, SPD2 is 0x00B, SPD3 is 0x00C):				
		SPD3	SPD2	SPD1	Parameter	Speed mode
		0	0	0	P0.46	Internal speed 1
		0	0	1	P0.47	Internal speed 2
		0	1	0	P0.48	Internal speed 3
0		1	P0.49	Internal		



This parameter is used to set the forward/reverse direction when P0.40 is 0 and 1 and the speed command sign is selected to S-SIGN.

Setting value	Internal speed step/analog input		Speed command sign	Speed command direction
【0】	Positive speed	0~10V	No use	Forward direction
	Negative speed	-10V~0V	No use	Reverse direction
1	No use		Valid	Forward direction
	No use		Invalid	Reverse direction

P0.41	Data	16bit	Data format	DEC
	Modbus communication address	1082,1083	CANopen communication address	0x2029, 0x00

P0.42	Analog speed command gain	Setting range	Default	Unit	Available mode		
		10~2000	100	(r/min)/V	S		

1. The voltage of the analog speed command input corresponds to the changing gain of the motor command speed.
2. The relationship between the input voltage and the speed, the default value is that each 1V corresponds to 100r/min.

$$\text{Analog speed command} = \text{Input voltage} \times \text{P0.42}$$

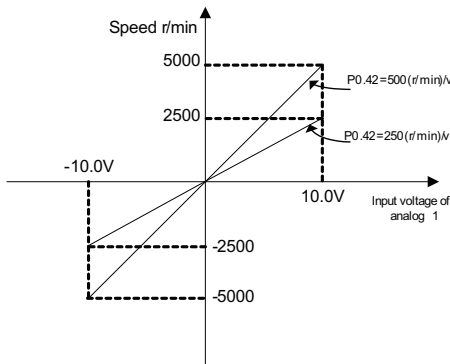

**Note:**

1. The default is the input signal from analog input terminal 1 of CN1 (AD1,GND and pin “1”,“5”).
2. This parameter is valid when the setting value of P0.40 is “1”.
3. Set the parameter correctly after confirming the motor operation, if the setting is too large, the motor speed will fluctuate a lot.
4. The voltage above -10~10V can not be present between AD1 and GND.

P0.42	Data	32bit	Data format	DEC
	Modbus communication address	1084,1085	CANopen communication address	0x202A, 0x00

P0.43	Analog speed command reverse	Setting range	Default	Unit	Available mode		
		0~1	0	-	S		

This parameter is used to set the polarity of the analog speed command.

Setting value	Motor direction	
<b>【0】</b>	Positive polarity	[+voltage]→[Positive],[ - voltage]→[Negative]
1	Negative polarity	[+voltage]→[Negative],[ - voltage]→[Positive]

P0.43	Data	16bit	Data format	DEC
	Modbus communication address	1086,1087	CANopen communication address	0x202B, 0x00

P0.45	Dead zone of analog speed command	Setting range	Default	Unit	Available mode		
		0.000~3.000	0.000	V	S		

If the absolute value of the command voltage is in this range, the corresponding speed command is 0.

P0.45	Data	16bit	Data format	DEC
	Modbus communication address	1090,1091	CANopen communication address	0x202D, 0x00

P0.46	Internal speed 1/ Speed limit 1	Setting range	Default	Unit	Available mode		
		-20000~20000	100	r/min		S	T
P0.47	Internal speed 2/ Speed limit 2	Setting range	Default	Unit	Available mode		
		-20000~20000	0	r/min		S	T
P0.48	Internal speed 3/ Speed limit 3	Setting range	Default	Unit	Available mode		
		-20000~20000	0	r/min		S	T
P0.49	Internal speed 4/ Speed limit 4	Setting range	Default	Unit	Available mode		
		-20000~20000	0	r/min		S	T
P0.50	Internal speed 5	Setting range	Default	Unit	Available mode		
		-20000~20000	0	r/min		S	
P0.51	Internal speed 6	Setting range	Default	Unit	Available mode		
		-20000~20000	0	r/min		S	
P0.52	Internal speed 7	Setting range	Default	Unit	Available mode		
		-20000~20000	0	r/min		S	
P0.53	Internal speed 8	Setting range	Default	Unit	Available mode		
		-20000~20000	0	r/min		S	

There are 8 internal speed commands and 4 internal speed limits.

Control mode	P0.40 Setting value	SPD3	SPD2	SPD1	Parameters and setting value
Speed mode	0	0	0	0	P0.46 internal speed 1
		0	0	1	P0.47 internal speed 2
		0	1	0	P0.48 internal speed 3
		0		1	P0.49 internal speed 4
		1	0	0	P0.50 internal speed 5
		1	0	1	P0.51 internal speed 6

Torque mode	0	1	1	0	P0.52 internal speed 7
		1	1	1	P0.53 internal speed 8
		0	0	0	P0.46 speed limit 1
		0	0	1	P0.47 speed limit 2
		0	1	0	P0.48 speed limit 3
		0	1	1	P0.49 speed limit 4

**Note:**1 SPD1,SPD2,SPD3 are the digital input or internal command 1~3(0x00A,0x00B,0x00C).

0: OFF (disconnected with COM-)

1: ON (connected with COM-)

2: The speed limit depends on the absolute value of the parameters and the direction is the same as the torque command.

P0.46	Data	16bit	Data format	DEC
	Modbus communication address	1092,1093	CANopen communication address	0x202E, 0x00
P0.47	Data	16bit	Data format	DEC
	Modbus communication address	1094,1095	CANopen communication address	0x202F, 0x00
P0.48	Data	16bit	Data format	DEC
	Modbus communication address	1096,1097	CANopen communication address	0x2030, 0x00
P0.49	Data	16bit	Data format	DEC
	Modbus communication address	1098,1099	CANopen communication address	0x2031, 0x00
P0.50	Data	16bit	Data format	DEC
	Modbus communication address	1100,1101	CANopen communication address	0x2032, 0x00
P0.51	Data	16bit	Data format	DEC
	Modbus communication address	1102,1103	CANopen communication address	0x2033, 0x00

P0.52	Data	16bit	Data format	DEC
	Modbus communication address	1104,1105	CANopen communication address	0x2034, 0x00
P0.53	Data	16bit	Data format	DEC
	Modbus communication address	1106,1107	CANopen communication address	0x2035, 0x00

P0.54	ACC time	Setting range	Default	Unit	Available mode		
		0~30000	0	ms		S	
P0.55	DEC time	Setting range	Default	Unit	Available mode		
		0~30000	0	ms		S	

ACC/DEC time is under the reference command, the time needed from 0r/min to the rated speed. When the reference speed is higher than or less than the rated speed, the actual ACC/DEC time will be accounted according to the percentage. If the speed is negative, the absolute value will be used to count the time.

**Example:** If the reference speed is 2000r/min, the rated speed is 3000r/min and the ACC/DEC time is set to 1500 and 1500, then the actual ACC time is  $1500 \times (2000/3000) = 1000\text{ms}$  and the DEC time is  $1500 \times (2000/3000) = 1000\text{ms}$ .

As the figure below:

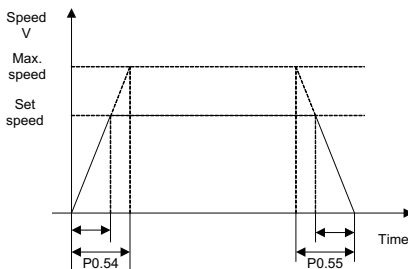

- Note:** 1 ACC/DEC time only can be used in the speed mode.  
 2 If the speed command is analog input, this function is invalid.

P0.54	Data	16bit	Data format	DEC
	Modbus communication	1108,1109	CANopen communication	0x2036, 0x00

	address		address	
P0.55	Data	16bit	Data format	DEC
	Modbus communication address	1110,1111	CANopen communication address	0x2037, 0x00

P0.56	ACC time of S curve	Setting range	Default	Unit	Available mode		
		0~1000	0	ms		S	
P0.57	DEC time of S curve	Setting range	Default	Unit	Available mode		
		0~1000	0	ms		S	

In a case of internal reference speed command, this parameter is used to set the duration of the circular arc segment during S curve decelerating and thus to achieve the goal of smoothly stopping. The ACC/DEC time of S curve is shown in the figure below:

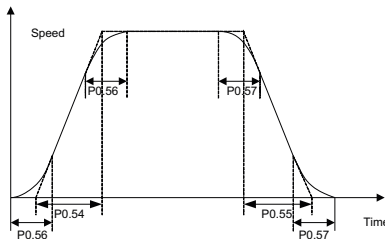

**Note:** 1. ACC/DEC time of S curve only can be used in the speed mode;

2. If the speed command is analog input, this function is invalid;

3. If the setting value of  $P0.54 < 2 * P0.56$  and  $P0.56$  is not 0, the actual operation time  $P0.54 = 2 * P0.56$ ;

4. If the setting value of  $P0.55 < 2 * P0.57$  and  $P0.57$  is not 0, the actual operation time  $P0.55 = 2 * P0.57$ .

P0.56	Data	16bit	Data format	DEC
	Modbus communication address	1112,1113	CANopen communication address	0x2038, 0x00
P0.57	Data	16bit	Data format	DEC
	Modbus communication address	1114,1115	CANopen communication address	0x2039, 0x00

	address		address	
--	---------	--	---------	--

P0.58	Zero speed clamp mode	Setting range	Default	Unit	Available mode		
		0~3	0	-	S	T	

This parameter is used to set the zero speed clamp mode.

Setting value	Position command mode
<b>【0】</b>	Invalid
1	If the control signal is valid, the speed command is forced to be 0
2	If the control signal is valid, the speed command is forced to be 0 and the actual speed of the motor is below P0.59, it will switch to position control and be locked on the position. The other action is the same as setting value 1.
3	If the control signal is valid, the speed command is forced to be 0 and the actual speed of the motor is below P0.59, it will switch to position control and be locked on the position.

**Note:**

1. If any one of P3.00~P3.09 has the function (0x00D), it can be controlled by the corresponding digital input of CN1; in the bus communication, it can be controlled by P4.19:0: Disabled;1: Enabled
2. In the torque mode, mode 0 and 1 are valid, mode 2 and 3 are the same as mode 1.

P0.58	Data	16bit	Data format	DEC
	Modbus communication address	1116,1117	CANopen communication address	0x203A, 0x00

P0.59	Speed threshold of zero speed clamp	Setting range	Default	Unit	Available mode		
		10~20000	30	r/min	S		

This parameter is used to set the position when P0.58 is 2 or 3. When P0.58 is 3, there is 10r/min delay when detection.

P0.59	Data	16bit	Data format	DEC
-------	------	-------	-------------	-----

	Modbus communication address	1118,1119	CANopen communication address	0x203B, 0x00
--	------------------------------	-----------	-------------------------------	--------------

P0.60	Torque command selection	Setting range	Default	Unit	Available mode		
		0~3	1	-			T

This parameter is used to set the command source of the torque control.

Setting value	Input method	Instruction
0	Internal setting	Set the required torque by setting P0.66.
<b>【1】</b>	Analog input	The input torque can be controlled by applying a voltage between -10V and 10V on the analog torque input terminals (AD2, GND and pin 20 and 19). By factory default, the positive value means forward and negative value means reverse. But it can be changed by setting parameters. Please refer to the detailed instruction.
2	Bus input	The torque command can be received by the bus communication interface. When P4.10 is 1, the motor torque can be changed by P4.14. Please refer to the detailed instruction of P4.10 and P4.14.
3	For factory	-

P0.60	Data	16bit	Data format	DEC
	Modbus communication address	1120,1121	CANopen communication address	0x203C, 0x00

P0.61	Torque command direction	Setting range	Default	Unit	Available mode		
		0~1	0	-			T

This parameter is used to select the torque command direction.



	Setting value	Designated method
	<b>【0】</b>	The direction is designated by the torque command. For example: torque command input [+] -> Positive direction, [-] -> Negative direction
	1	Determined by [0x00F] 1: Positive direction; 0:Negative direction

**Note:** 0x00F is valid when input low electric level and it is 0x10F when high electric level valid.

P0.61	Data	16bit	Data format	DEC
	Modbus communication address	1122,1123	CANopen communication address	0x203D, 0x00

P0.62	Analog torque command gain	Setting range	Default	Unit	Available mode		
		0~1000	100	(0.1%)/V			T

1. The voltage of the analog torque command input corresponds to the changing gain of the motor command torque.
2. The relationship between the input voltage and the torque, the default value is that each 1V corresponds to 10% of the rated torque.

Analog torque command = Input voltage x P0.62

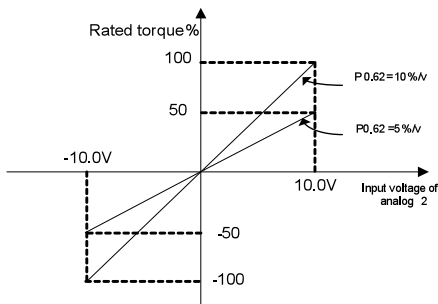

**Note:**

1. The default is the input signal from analog input terminal 1 of CN1 (AD1, GND and pin “20”, “19”).
2. Set the parameter correctly after confirming the motor operation, if the setting is too large, the motor torque will fluctuate a lot.

P0.62	Data	32bit	Data format	DEC
-------	------	-------	-------------	-----

	Modbus communication address	1124,1125	CANopen communication address	0x203E, 0x00
--	------------------------------	-----------	-------------------------------	--------------

P0.63	Analog torque command reverse	Setting range	Default	Unit	Available mode		
		0~1	0	-			T

This parameter is used to set the polarity of the analog torque command.

Setting value	Motor direction	
【0】	Positive polarity	[+voltage]→[Positive],[ - voltage]→[Negative]
1	Negative polarity	[+voltage]→[Negative],[ - voltage]→[Positive]

P0.63	Data	16bit	Data format	DEC
	Modbus communication address	1126,1127	CANopen communication address	0x203F, 0x00

P0.65	Dead zone of analog torque command	Setting range	Default	Unit	Available mode		
		0.000~3.000	0.000	V			T

If the absolute value of the command voltage is in this range, the corresponding torque command is 0.

P0.65	Data	16bit	Data format	DEC
	Modbus communication address	1130,1131	CANopen communication address	0x2041, 0x00

P0.66	Internal speed command	Setting range	Default	Unit	Available mode		
		-500.0~500.0	0.0	%			T

**Note:**

1. If the absolute value of this parameter is larger than the Max. torque limit 1, then the output torque is the setting value of P0.10.

0: OFF (disconnected with COM-)  
 1: ON (connected with COM-)  
 2: In the torque mode, this parameter is valid when the setting value of P0.60 is "0".

P0.66	Data	16bit	Data format	DEC
	Modbus communication address	1132,1133	CANopen communication address	0x2042, 0x00

P0.67	Speed limit setting	Setting range	Default	Unit	Available mode		
		0~1	1	-			T

In the torque control mode, this parameter is used to set the speed limit mode.

Setting value	Designated method
0	Select the analog input as the speed limit. It is necessary to configure analog input 3 as the speed limit function and refer to P0.42~P0.45 for the marking mode.
<b>【1】</b>	Select the internal speed limit and any one of P0.46~P0.49 may be selected

P0.67	Data	16bit	Data format	DEC
	Modbus communication address	1134,1135	CANopen communication address	0x2043, 0x00

P0.68	RAMP time of torque command	Setting range	Default	Unit	Available mode		
		0~10000	0	ms			T

This parameter is used to modify the planning curve when the command input changes, and it is the raising time form 0 to 100%.

P0.68	Data	16bit	Data format	DEC
	Modbus communication address	1136,1137	CANopen communication address	0x2044, 0x00

P0.69	DEC time of fast stop	Setting	Default	Unit	Available mode
-------	-----------------------	---------	---------	------	----------------

			range						
			0~10000	500	ms	P	S	T	F
This parameter is used to modify the DEC time of fast stop, and it is the raising time form 100% to 0.									
P0.69	Data	16bit	Data format	DEC					
	Modbus communication address	1138,1139	CANopen communication address	0x2045, 0x00					

	P0.70	Absolute encoder setting	Setting range	Default	Unit	Available mode			
			0~1	0	-	P	S	T	F
This parameter is used to modify the operation mode of the absolute encoder. When the encoder has multiple circles, it can be used as the single-circle as the default; and when it needs the multiple circle function, it is necessary to prepare the spare battery and set it as the multiple modes.									
		Setting value	Method						
		【0】	Single circle						
		1	Multiple circles						

P0.70	Data	16bit	Data format	DEC					
	Modbus communication address	1140,1141	CANopen communication address	0x2046, 0x00					

	P0.71	Absolute encoder clearing	Setting range	Default	Unit	Available mode			
			0~1	0	-	P	S	T	F

This parameter is used to clear the multiple-circle encoder.									
P0.71	Data	16bit	Data format	DEC					
	Modbus communication address	1142,1143	CANopen communication address	0x2047, 0x00					

**6.1.4 Control mode switching**

P0.90	Max. speed limit of the control mode switching	Setting range	Default	Unit	Available mode			
		0~1000	100	r/min	P	S	T	
This parameter is used to set the maximum operation speed during the positioning.								
P0.90	Data	16bit	Data format	DEC				
	Modbus communication address	1180,1181	CANopen communication address	0x205A, 0x00				

P0.91	Positioning reference of the control mode switching	Setting range	Default	Unit	Available mode			
		-1~1048575	-1	pulse	P	S	T	
This parameter is used to set the positioning reference of the control mode switching.								
<b>Note:</b>								
1. After the switching, the reference point of the received position command is the setting value of the parameter and the unit is the unit of the encoder pulse.								
2. When it is set to be -1 and switches from speed mode to the position mode, there is no positioning action and it will switch at the current position.								
3. If the mechanical angle of P3.50 is less than 0.5° , then the positioning precision is ±P3.50; if the angle is higher than 0.5° , then the positioning precision is the pulse number of ±0.5° .								
P0.91	Data	32bit	Data format	DEC				
	Modbus communication address	1182,1183	CANopen communication address	0x205B, 0x00				

P0.92	Exiting mode of the position mode switching	Setting range	Default	Unit	Available mode			
		0~1	0	-	P	S	T	
When P0.03 is 3 or 4, this parameter is used to set the exiting mode when the position mode can be switched to other modes.								
Setting value		Exiting mode						
【0】		Switch from position mode to other mode after positioning						
1		Switch to other mode when the control mode switching						

		command is invalid		
P0.92	Data	32bit	Data format	DEC
	Modbus communication address	1184,1185	CANopen communication address	0x205C, 0x00

## 6.2 Autoturning control parameters (P1)

### 6.2.1 Inertia identification (Automatic gain)

P1.00	On-line automatic setting	Setting range	Default	Unit	Available mode			
		0~1	0	%	P	S	T	F

This parameter is used to set whether to adjust the inertia ratio and adjust the gain automatically.

Setting value	Meaning
【0】	Invalid
1	Valid

P1.00	Data	16bit	Data format	DEC
	Modbus communication address	1200,1201	CANopen communication address	0x2100,0x00

P1.01	1 <sup>st</sup> inertia ratio	Setting range	Default	Unit	Available mode			
		0~10000	250	%	P	S	T	F

Rotary inertia ratio = Load inertia /motor rotary inertia x 100%,

If P1.01 is set correctly, the setting unit of P2.00 and P2.05 is Hz.

If P1.01 is larger than the actual value, the speed loop gain unit will increase, and if it is smaller than the actual value, the speed loop gain unit will decrease.

If the online adjustment is valid, the real time inertia ratio will be updated to P1.01 and saved into EEPROM every 30 minutes.

P1.01	Data	16bit	Data format	DEC
	Modbus communication address	1202,1203	CANopen communication address	0x2101,0x00

	P1.02	2 <sup>nd</sup> inertia ratio	Setting range	Default	Unit	Available mode				
			0~10000	250	%	P	S	T	F	
<p>The definition is the same as P1.01.</p> <p><b>Note:</b> The automatic online gain adjustment is invalid for this parameter.</p>										
P1.02	Data	16bit	Data format	DEC						
	Modbus communication address	1204,1205	CANopen communication address	0x2102,0x00						

	P1.03	Machine rigidity setting	Setting range	Default	Unit	Available mode				
			0~31	13	-	P	S	T	F	
<p>The bigger the value is, the faster response and higher rigidity and easier vibration. In stable system, higher rigidity setting makes fast response.</p>										
		<b>Mechanical structure</b>	<b>Rigid set</b>							
		Big handling, transmission equipment	0~13							
		Belt drive mechanism	5~16							
		Manipulator	10~20							
		Ball screw + Belt drive	13~25							
		Direct ball screw or rigid bodies	18~31							
P1.03	Data	16bit	Data format	DEC						
	Modbus communication address	1206,1207	CANopen communication address	0x2103,0x00						

	P1.04	Inertia identification switch	Setting range	Default	Unit	Available mode				
			0~1	0	-	P	S	T	F	
<p>The parameter is used to select whether the function is valid or not. After setting the inertia identification, the motor will run 6 cycles to carry out the inertia identification. In each cycle, the motor will run at the mode of P1.05, the maximum cycle is determined by P1.06 and the ACC command time is determined by P1.07.</p>										

	Setting value	Function
	<b>【0】</b>	Inertia identification switch off
	1	Inertia identification switch on

**Note:**

1. The motor speed will be faster if the values of P1.06 and P1.07 are bigger.
2. Refer to chapter 10.1 if the drive reports Er25-7.
3. This parameter is invalid in the servo enabling state.

P1.04*	Data	16bit	Data format	DEC
	Modbus communication address	1208,1209	CANopen communication address	0x2104,0x00

P1.05	Operation mode of inertia identification	Setting range	Default	Unit	Available mode			
		0~3	0	-	P	S	T	F

This parameter is used to set the operation mode of inertia identification.

Setting value	Function
<b>【0】</b>	Forward rotation and then reverse rotation
1	Forward rotation
2	Reverse rotation
3	Reverse rotation and then forward rotation

P1.05	Data	16bit	Data format	DEC
	Modbus communication address	1210,1211	CANopen communication address	0x2105,0x00

P1.06	Range of inertia identification	Setting range	Default	Unit	Available mode			
		0.2~20	2.0	r	P	S	T	F

In the position mode, this parameter is used to limit the maximum circle number in each cycle.

P1.06	Data	16bit	Data format	DEC
	Modbus communication	1212,1213	CANopen communication	0x2106,0x00



	address		address	
--	---------	--	---------	--

	P1.07	Time constant of ACC time	Setting range	Default	Unit	Available mode			
			2~1000	200	ms	P	S	T	F

This parameter is used to set the motor ACC time during the inertia identification. If the load inertia is large, the ACC time can be set as a large value to avoid the overload alarm.

P1.07	Data	16bit	Data format	DEC
	Modbus communication address	1214,1215	CANopen communication address	0x2107,0x00

	P1.08	Speed level of inertia identification	Setting range	Default	Unit	Available mode			
			0~3	1	-	P	S	T	F

This parameter is used to set the speed level of inertia identification. The setting value is larger, the more fast of the response and larger fluctuation of the presumption value. The presumption result can be saved every 30 minutes.

Setting value	Function	Meaning
0	No change	Stop the presumption of load characteristic
<b>【1】</b>	Basic no change	No change to the load characteristic
2	Change slowly	Slow change to the load characteristic
3	Change fast	Rapid change to the load characteristic

P1.08	Data	16bit	Data format	DEC
	Modbus communication address	1216,1217	CANopen communication address	0x2108,0x00

**6.2.2 Adaptive vibration control**

	P1.19	Valid resonance detection bit	Setting range	Default	Unit	Available mode				
			1.0~100.0	5.0	%	P	S	T	F	
<p>This parameter is used to set the sensitivity of the automatic test for the mechanical resonance frequency. The smaller the value is the higher sensitivity to the resonance.</p> <p><b>Note:</b> When the setting value of P1.19 is increasing, the senility to the resonance is reducing.</p>										
P1.19	Data	16bit	Data format	DEC						
	Modbus communication address	1238,1239	CANopen communication address	0x2113,0x00						

	P1.20	Resonance test mode	Setting range	Default	Unit	Available mode				
			0~7	0	-	P	S	T	F	
<p>This parameter is used to set the resonance test mode and the resonance number and action after signal releasing.</p> <p>If the function is valid (1, 2, 3), the system will analyze automatic gathering data for the mechanical resonance frequency and the result is saved in P1.21 and P1.22. The user can set the frequency of notch filter according to P1.21 and P1.22 to eliminate the mechanical resonance.</p> <p><b>Note:</b> The setting value is invalid after the adjustment.</p>										
		Setting value	Function	Meaning						
		【0】	Invalid	All relative parameters keep no change						
		1	1 notch filter valid	The relative parameters of the 3 <sup>rd</sup> notch filter will be updated according to the autotuning result.						
		2	2 notch filters valid	The relative parameters of the 3 <sup>rd</sup> and 4 <sup>th</sup> notch filters will be updated according to the autotuning result.						
		3	Resonance frequency test mode	No relative parameters						
		4	Parameters clear	Restore to the default values						

	5	the 3 <sup>rd</sup> notch filter->the 1 <sup>st</sup> notch filter	Copy the parameters of the 3 <sup>rd</sup> notch filter to the 1 <sup>st</sup> notch filter and then restore the parameter of the 3 <sup>rd</sup> notch filter to the default values	
	6	the 4 <sup>th</sup> notch filter->the 2 <sup>nd</sup> notch filter	Copy the parameters of the 4 <sup>th</sup> notch filter to the 2 <sup>nd</sup> notch filter and then restore the parameter of the 4 <sup>th</sup> notch filter to the default values	
	7	the 3 <sup>rd</sup> and 4 <sup>th</sup> notch filter-> the 1 <sup>st</sup> and 2 <sup>nd</sup> notch filter	Copy the parameters of the 3 <sup>rd</sup> and 4 <sup>th</sup> notch filter to the 1 <sup>st</sup> and 2 <sup>nd</sup> notch filter and then restore the parameter of the 3 <sup>rd</sup> and 4 <sup>th</sup> notch filter to the default values	
P1.20	Data	16bit	Data format	DEC
	Modbus communication address	1240,1241	CANopen communication address	0x2114,0x00

P1.21*	1 <sup>st</sup> mechanical resonance frequency	Setting range	Default	Unit	Available mode			
		0~5000	5000	Hz	P	S	T	F
P1.22*	2 <sup>nd</sup> mechanical resonance frequency	Setting range	Default	Unit	Available mode			
		0~5000	5000	Hz	P	S	T	F

This parameter is used to display the resonance frequency. When P1.20 is set to "1", the system will detect the frequency on the Max. resonance and display it by the function codes.

**Note:**

1. When the speed reaches above 30r/min, the measuring value will be correct.
2. This function is only for read and can not be set. The user can set the frequency of the notch filter according to the function code to remove the resonance.
3. 5000 indicates the resonance point is not found.

P1.21	Data	16bit	Data format	DEC
	Modbus communication address	1242,1243	CANopen communication address	0x2115, 0x00
P1.22	Data	16bit	Data format	DEC

	Modbus communication address	1244,1245	CANopen communication address	0x2116, 0x00
--	------------------------------	-----------	-------------------------------	--------------

	P1.23	1 <sup>st</sup> trap wave frequency	Setting range	Default	Unit	Available mode			
			50~5000	5000	Hz	P	S	T	F

This parameter is used to set the frequency of the 1<sup>st</sup> trap wave filter for suppressing resonance. The trap wave filters can simulate the mechanical resonant frequency and thus suppress the resonant frequency.  
5000: invalid.

P1.23	Data	16bit	Data format	DEC
	Modbus communication address	1246,1247	CANopen communication address	0x2117,0x00

	P1.24	Q value of 1 <sup>st</sup> trap wave	Setting range	Default	Unit	Available mode			
			0.50~16.00	1.00	-	P	S	T	F

This parameter is used to set the Q value of the 1<sup>st</sup> trap wave filter  
Q=1<sup>st</sup> trap wave frequency/1<sup>st</sup> trap wave width. Generally, it can use the factory setting value.

P1.24	Data	16bit	Data format	DEC
	Modbus communication address	1248,1249	CANopen communication address	0x2118,0x00

	P1.25	1 <sup>st</sup> trap wave depth	Setting range	Default	Unit	Available mode			
			0~100	0	%	P	S	T	F

This parameter is used to set the trap wave depth of the 1<sup>st</sup> trap wave filter for suppressing resonant. A larger trap wave depth can be less with a larger setting.

P1.25	Data	16bit	Data format	DEC
	Modbus communication address	1250,1251	CANopen communication address	0x2119,0x00

P1.26	2 <sup>nd</sup> trap wave frequency	Setting range	Default	Unit	Available mode			
		50~5000	5000	Hz	P	S	T	F
P1.27	Q value of 2 <sup>nd</sup> trap wave	Setting range	Default	Unit	Available mode			
		0.50~16.00	1.00	-	P	S	T	F
P1.28	2 <sup>nd</sup> trap wave depth	Setting range	Default	Unit	Available mode			
		0~100	0	%	P	S	T	F

Refer to P1.23, P1.24 and P1.25 for detailed parameters setting.

P1.26	Data	16bit	Data format	DEC
	Modbus communication address	1252,1253	CANopen communication address	0x211A,0x00
P1.27	Data	16bit	Data format	DEC
	Modbus communication address	1254,1255	CANopen communication address	0x211B,0x00
P1.28	Data	16bit	Data format	DEC
	Modbus communication address	1256,1257	CANopen communication address	0x211C,0x00

P1.29	3 <sup>rd</sup> trap wave frequency	Setting range	Default	Unit	Available mode			
		50~5000	5000	Hz	P	S	T	F
P1.30	Q value of 3 <sup>rd</sup> trap wave	Setting range	Default	Unit	Available mode			
		0.50~16.00	1.00	-	P	S	T	F
P1.31	3 <sup>rd</sup> trap wave depth	Setting range	Default	Unit	Available mode			
		0~100	0	%	P	S	T	F

Refer to P1.23 ,P1.24 and P1.25 for detailed parameters setting.

P1.29	Data	16bit	Data format	DEC
-------	------	-------	-------------	-----

	Modbus communication address	1258,1259	CANopen communication address	0x211D,0x00
P1.30	Data	16bit	Data format	DEC
	Modbus communication address	1260,1261	CANopen communication address	0x211E,0x00
P1.31	Data	16bit	Data format	DEC
	Modbus communication address	1262,1263	CANopen communication address	0x211F,0x00

P1.32	4 <sup>th</sup> trap wave frequency	Setting range	Default	Unit	Available mode			
		50~5000	5000	Hz	P	S	T	F
P1.33	Q value of 4 <sup>th</sup> trap wave	Setting range	Default	Unit	Available mode			
		0.50~16.00	1.00	-	P	S	T	F
P1.34	4 <sup>th</sup> trap wave depth	Setting range	Default	Unit	Available mode			
		0~100	0	%	P	S	T	F

Refer to P1.23 ,P1.24 and P1.25 for detailed parameters setting.

P1.32	Data	16bit	Data format	DEC
	Modbus communication address	1264,1265	CANopen communication address	0x2120,0x00
P1.33	Data	16bit	Data format	DEC
	Modbus communication address	1266,1267	CANopen communication address	0x2121,0x00
P1.34	Data	16bit	Data format	DEC
	Modbus communication address	1268,1269	CANopen communication address	0x2122,0x00

	P1.35	Vibration control selection	Setting range	Default	Unit	Available mode			
			0~2	0	-	P			

This parameter is used to set the switching mode.

Setting value	Function
【0】	The 1 <sup>st</sup> vibration control is valid
1	Switch according to VS-SEL
2	Automatic

**Note:** The relationship between VS-SEL and COM-:

0:OFF

1:ON

P1.35	Data	16bit	Data format	DEC
	Modbus communication address	1270,1271	CANopen communication address	0x2123,0x00

	P1.36	The 1 <sup>st</sup> vibration control frequency	Setting range	Default	Unit	Available mode			
			0.0~200.0	0.0	Hz	P			

It is used to set the frequency reducing ratio of the control load and the frequency at the peak of the load.

**Note:** Invalid if the setting value is below 1.0Hz.

P1.36	Data	16bit	Data format	DEC
	Modbus communication address	1272,1273	CANopen communication address	0x2124,0x00

	P1.37	The 1 <sup>st</sup> vibration control factor	Setting range	Default	Unit	Available mode			
			0.00~1.00	1.00	-	P			

This parameter is used to set the filter factor.

P1.37	Data	16bit	Data format	DEC
	Modbus communication address	1274,1275	CANopen communication address	0x2125,0x00

P1.38	The 2 <sup>nd</sup> vibration control frequency	Setting range	Default	Unit	Available mode			
		0.0~200.0	0.0	Hz	P			F
P1.39	The 2 <sup>nd</sup> vibration control factor	Setting range	Default	Unit	Available mode			
		0.00~1.00	1.00	-	P			F
Please refer to P1.36 and P1.37 for the detailed information.								
P1.38	Data	16bit	Data format		DEC			
	Modbus communication address	1276,1277	CANopen communication address		0x2126,0x00			
P1.39	Data	16bit	Data format		DEC			
	Modbus communication address	1278,1279	CANopen communication address		0x2127,0x00			

### 6.3 Motor control parameters (P2)

#### 6.3.1 Gain setting

P2.00	1 <sup>st</sup> speed gain	Setting range	Default	Unit	Available mode			
		0.1~3276.7	27.0	Hz	P	S	T	F
This parameter is used to set the gain of the speed loop. When the setting is increased, the speed response will be improved, but it may easily cause vibration and noise.								
<b>Note:</b> If the inertia ratio is set correctly, the unit of P2.00 is Hz.								
P2.00	Data	16bit	Data format		DEC			
	Modbus communication address	1400,1401	CANopen communication address		0x2200,0x00			

P2.01	1 <sup>st</sup> speed integration time constant	Setting range	Default	Unit	Available mode			
		0.1~1000.0	21.0	ms	P	S	T	F
This parameter is used to set the integration time constant of the speed loop. The response may be improved by decreasing the setting, but this parameter may easily cause vibration and								



noise. It should be noted particularly that when this parameter is set as 1000, it means the integral action is invalid.

P2.01	Data	16bit	Data format	DEC
	Modbus communication address	1402,1403	CANopen communication address	0x2201, 0x00

P2.02	1 <sup>st</sup> position gain	Setting range	Default	Unit	Available mode			
		0.0~3276.7	48.0	1/s	P			F

This parameter is used to set the gain of the position loop. When the setting is increased, the position response will be improved, but it may easily cause vibration and noise.

P2.02	Data	16bit	Data format	DEC
	Modbus communication address	1404,1405	CANopen communication address	0x2202, 0x00

P2.03	1 <sup>st</sup> speed detection filter time	Setting range	Default	Unit	Available mode			
		0~5	0	-	P	S	T	F

This parameter is used to set the time constant of the speed detect filter. Large setting value can reduce motor noise and speed fluctuation and also reduce response performance. Please set the parameter to factory value [0].

P2.03	Data	16bit	Data format	DEC
	Modbus communication address	1406,1407	CANopen communication address	0x2203, 0x00

P2.04	1 <sup>st</sup> torque filter	Setting range	Default	Unit	Available mode			
		0.00~25.00	0.84	ms	P	S	T	F

This parameter is used to set the time constant of torque filter.

P2.04	Data	16bit	Data format	DEC
	Modbus communication address	1408,1409	CANopen communication address	0x2204,0x00

	address		address	
--	---------	--	---------	--

	P2.05	2 <sup>nd</sup> speed gain	Setting range	Default	Unit	Available mode			
			0.0~3276.7	27.0	Hz	P	S	T	F
	P2.06	2 <sup>nd</sup> speed integration time constant	Setting range	Default	Unit	Available mode			
			0.1~1000.0	1000.0	ms	P	S	T	F
	P2.07	2 <sup>nd</sup> position gain	Setting range	Default	Unit	Available mode			
			0.0~3276.7	57.0	1/s	P			F
	P2.08	2 <sup>nd</sup> speed detection filter time	Setting range	Default	Unit	Available mode			
			0~5	0	-	P	S	T	F
	P2.09	2 <sup>nd</sup> torque filter	Setting range	Default	Unit	Available mode			
			0.00~25.00	0.84	ms	P	S	T	F

There are two groups of parameters for position gain, speed gain and speed integration time constant.

The definition of the function and content are the same as those of 1<sup>st</sup> group.

The user can select or switch between 1<sup>st</sup> gain and 2<sup>nd</sup> gain according to the requirement.

Please refer to the detailed information of P2.20 and P2.34.

P2.05	Data	16bit	Data format	DEC
	Modbus communication address	1410,1411	CANopen communication address	0x2205,0x00
P2.06	Data	16bit	Data format	DEC
	Modbus communication address	1412,1413	CANopen communication address	0x2206,0x00
P2.07	Data	16bit	Data format	DEC
	Modbus communication address	1414,1415	CANopen communication address	0x2207,0x00
P2.08	Data	16bit	Data format	DEC

	Modbus communication address	1416,1417	CANopen communication address	0x2208,0x00
P2.09	Data	16bit	Data format	DEC
	Modbus communication address	1418,1419	CANopen communication address	0x2209,0x00

P2.10	Speed feed-forward gain	Setting range	Default	Unit	Available mode		
		0.0~100.0	0.0	%	P		F
<p>This parameter is used to set the speed feed-forward gain. When the parameter is 100%, the retention pulse running at a certain speed will be almost zero; sudden ACC/DEC will enlarge overshooting.</p>							
P2.10	Data	16bit	Data format	DEC			
	Modbus communication address	1420,1421	CANopen communication address	0x220A, 0x00			

P2.11	Speed feed-forward filter time constant	Setting range	Default	Unit	Available mode		
		0.00~64.00	0.50	ms	P		F
<p>This parameter is used to set the speed feed-forward filter time constant.</p>							
P2.11	Data	16bit	Data format	DEC			
	Modbus communication address	1422,1423	CANopen communication address	0x220B,0x00			

P2.12	Torque feed-forward gain	Setting range	Default	Unit	Available mode		
		0.0~100.0	0.0	%	P	S	F
<p>This parameter is used to set the torque feed-forward gain. After the torque command calculated according to speed control command multiplies the rate of the parameter, add to the torque command from speed control step.</p> <p>Increasing torque feed-forward gain can improve response performance in ACC/DEC and</p>							

reduce position deviation.				
P2.12	Data	16bit	Data format	DEC
	Modbus communication address	1424,1425	CANopen communication address	0x220C, 0x00

P2.13	Torque feed-forward filter time constant	Setting range	Default	Unit	Available mode				
		0.00~64.00	0.00	ms	P	S		F	
This parameter is used to set the torque feed-forward filter time constant.									
P2.13	Data	16bit	Data format	DEC					
	Modbus communication address	1426,1427	CANopen communication address	0x220D,0x00					

6.3.2 Gain switching

P2.20	2 <sup>nd</sup> gain setting	Setting range	Default	Unit	Available mode				
		0~1	1	-	P	S	T	F	
This parameter is used to set the right adjustment.									
		Setting value	Mode						
		0	The 1 <sup>st</sup> gain is the fixed. The action of speed loop will be switched into PI action/P action according to gain switching or P4.16. Gain switching invalid→PI action Gain switching valid→P action <b>Note:</b> 0x006 is the digital input low level valid and the high level valid is 0x106.						
		【1】	Valid between 1 <sup>st</sup> gain [P2.00~P2.04] and 2 <sup>nd</sup> gain [P2.05~P2.09].						
P2.20	Data	16bit	Data format	DEC					
	Modbus communication address	1440,1441	CANopen communication address	0x2214,0x00					

P2.22	Position mode gain switching	Setting range	Default	Unit	Available mode			
		0~9	0	-	P			F
The trigger conditions of switching are as below:								
Setting value	Switching condition	Gain condition						
<b>【0】</b>	1 <sup>st</sup> gain fixed	Be fixed in the 1 <sup>st</sup> gain [P2.00~P2.04]						
1	2 <sup>nd</sup> gain fixed	Be fixed in the 2 <sup>nd</sup> gain fixed [P2.05~P2.09]						
2	Switching input with gain	Invalid: the 1 <sup>st</sup> gain Valid: the 2 <sup>nd</sup> gain						
3	Large torque command	In the previous 1 <sup>st</sup> gain, if the absolute value of the torque command exceed, it will switch to the 2 <sup>nd</sup> gain In the previous 2 <sup>nd</sup> gain, if the absolute value of the torque command last in the delay time, it will return to the 1 <sup>st</sup> gain						
4	Large speed command	In the previous 1 <sup>st</sup> gain, if the absolute value of the speed command exceed, it will switch to the 2 <sup>nd</sup> gain In the previous 2 <sup>nd</sup> gain, if the absolute value of the speed command last in the delay time, it will return to the 1 <sup>st</sup> gain						
5	Large position deviation	In the previous 1 <sup>st</sup> gain, if the absolute value of the position deviation exceed, it will switch to the 2 <sup>nd</sup> gain In the previous 2 <sup>nd</sup> gain, if the absolute value of the position deviation last in the delay time, it will return to the 1 <sup>st</sup> gain						
6	With position command	In the previous 1 <sup>st</sup> gain, if the position command is not 0, it will switch to the 2 <sup>nd</sup> gain In the previous 2 <sup>nd</sup> gain, if the 0 position command last in the delay time, it will return to the 1 <sup>st</sup> gain						
7	Positioning not finished	In the previous 1 <sup>st</sup> gain, if the positioning is not finished, it will switch to the 2 <sup>nd</sup> gain In the previous 2 <sup>nd</sup> gain, if the state of positioning finished last in the delay time, it will return to the 1 <sup>st</sup> gain						
8	Large actual speed	In the previous 1 <sup>st</sup> gain, if the absolute value of the actual speed exceed, it will switch to the 2 <sup>nd</sup> gain In the previous 2 <sup>nd</sup> gain, if the absolute value of the actual						

		speed last in the delay time, it will return to the 1 <sup>st</sup> gain		
9	With position command+ actual speed	In the previous 1 <sup>st</sup> gain, if the position command is not 0, it will switch to the 2 <sup>nd</sup> gain In the previous 2 <sup>nd</sup> gain, if the 0 position command last in the delay time, it will return to the 1 <sup>st</sup> gain		
P2.22	Data	16bit	Data format	DEC
	Modbus communication address	1444,1445	CANopen communication address	0x2216,0x00

P2.23	Delay time of position control switching	Setting range	Default	Unit	Available mode		
		0~10000	0	ms	P		F
In the position control, if set P2.22 to be 3~9, when switch from the 2 <sup>nd</sup> gain to the 1 <sup>st</sup> gain, it is the time from meeting the trigger conditions to the actual switching.							
P2.23	Data	16bit	Data format	DEC			
	Modbus communication address	1446,1447	CANopen communication address	0x2217,0x00			

P2.24	Switching level of position control	Setting range	Default	Unit	Available mode		
		0~20000	0	To the mode	P		F
In the position control, if set P2.22 to be 3~5,8,9, it is necessary to set switching conditions. The unit will be different to the mode and setting.							
<b>Note:</b> Please set the degree $\geq$ the delay							
P2.24	Data	16bit	Data format	DEC			
	Modbus communication address	1448,1449	CANopen communication address	0x2218,0x00			

P2.25	Switching delay of the position control	Setting range	Default	Unit	Available mode		
		0~20000	0	To the	P		F

					mode			
<p>In the position control, if set P2.22 to be 3~5,8,9, it is necessary to set switching conditions. The unit will be different to the mode and setting.</p> <p><b>Note:</b> Please set the degree&lt;the delay, in the actual application, the delay=the degree</p>								
P2.25	Data	16bit	Data format	DEC				
	Modbus communication address	1450,1451	CANopen communication address	0x2219,0x00				

P2.26	Switching time of position gain	Setting range	Default	Unit	Available mode		
		0~10000	0	ms	P		F
<p>In the position control, if the offset between P2.00 and P2.04 is large, setting this parameter can control the torque changing and vibration caused by increasing gain. The parameter is invalid when the position gain is switched from a large value to a smaller one.</p>							
P2.26	Data	16bit	Data format	DEC			
	Modbus communication address	1452,1453	CANopen communication address	0x221A,0x00			

P2.27	Switching mode of speed control	Setting range	Default	Unit	Available mode		
		0~5	0	-	S		

The trigger conditions of switching are as below:

Setting value	Switching condition	Gain condition
<b>【0】</b>	1 <sup>st</sup> gain fixed	Be fixed in the 1 <sup>st</sup> gain [P2.00~P2.04]
1	2 <sup>nd</sup> gain fixed	Be fixed in the 2 <sup>nd</sup> gain fixed [P2.05~P2.09]
2	Switching input with gain	Invalid: the 1 <sup>st</sup> gain Valid: the 2 <sup>nd</sup> gain
3	Torque command	In the previous 1 <sup>st</sup> gain, if the absolute value of the torque command exceed, it will switch to the 2 <sup>nd</sup> gain In the previous 2 <sup>nd</sup> gain, if the absolute value of the torque command last in the delay time, it will return to the 1 <sup>st</sup> gain
4	Speed command variable	In the previous 1 <sup>st</sup> gain, if the absolute value of the speed command variable exceed, it will switch to the 2 <sup>nd</sup> gain In the previous 2 <sup>nd</sup> gain, if the absolute value of the speed command variable last in the delay time, it will return to the 1 <sup>st</sup> gain
5	Speed command	In the previous 1 <sup>st</sup> gain, if the absolute value of the speed command exceed, it will switch to the 2 <sup>nd</sup> gain In the previous 2 <sup>nd</sup> gain, if the absolute value of the speed command last in the delay time, it will return to the 1 <sup>st</sup> gain

**Note:** The parameter is invalid to the position gain. The actual position gain is the 1st gain.

P2.27	Data	16bit	Data format	DEC
	Modbus communication address	1454,1455	CANopen communication address	0x221B,0x00

P2.28	Delay time of speed control switching	Setting range	Default	Unit	Available mode
		0~10000	0	ms	S

In the speed control, if set P2.27 to be 3~5, when switch from the 2<sup>nd</sup> gain to the 1<sup>st</sup> gain, it is the time from meeting the trigger conditions to the actual switching.

P2.28	Data	16bit	Data format	DEC
	Modbus communication address	1456,1457	CANopen communication address	0x221C,0x00



	P2.29	Switching level of speed control	Setting range	Default	Unit	Available mode		
			0~20000	0	To the mode	S		
<p>In the speed control, if set P2.27 to be 3~5, it is necessary to set switching conditions. The unit will be different to the mode and setting.</p> <p><b>Note:</b> Please set the degree <math>\geq</math> the delay</p>								
P2.29	Data	16bit	Data format	DEC				
	Modbus communication address	1458,1459	CANopen communication address	0x221D,0x00				

	P2.30	Switching delay of the speed control	Setting range	Default	Unit	Available mode		
			0~20000	0	To the mode	S		
<p>In the position control, if set P2.27 to be 3~5, it is necessary to set switching conditions. The unit will be different to the mode and setting.</p> <p><b>Note:</b> Please set the degree &lt; the delay, in the actual application, the delay = the degree</p>								
P2.30	Data	16bit	Data format	DEC				
	Modbus communication address	1460,1461	CANopen communication address	0x221E,0x00				

	P2.31	Switching mode of torque control	Setting range	Default	Unit	Available mode														
			0~3	0	-			T												
<p>The trigger conditions of switching are as below:</p> <table border="1"> <thead> <tr> <th>Setting value</th> <th>Switching condition</th> <th>Gain condition</th> </tr> </thead> <tbody> <tr> <td>【0】</td> <td>1<sup>st</sup> gain fixed</td> <td>Be fixed in the 1<sup>st</sup> gain [P2.00~P2.04]</td> </tr> <tr> <td>1</td> <td>2<sup>nd</sup> gain fixed</td> <td>Be fixed in the 2<sup>nd</sup> gain fixed [P2.05~P2.09]</td> </tr> <tr> <td>2</td> <td>Switching input with gain</td> <td>Invalid: the 1<sup>st</sup> gain Valid: the 2<sup>nd</sup> gain</td> </tr> </tbody> </table>									Setting value	Switching condition	Gain condition	【0】	1 <sup>st</sup> gain fixed	Be fixed in the 1 <sup>st</sup> gain [P2.00~P2.04]	1	2 <sup>nd</sup> gain fixed	Be fixed in the 2 <sup>nd</sup> gain fixed [P2.05~P2.09]	2	Switching input with gain	Invalid: the 1 <sup>st</sup> gain Valid: the 2 <sup>nd</sup> gain
Setting value	Switching condition	Gain condition																		
【0】	1 <sup>st</sup> gain fixed	Be fixed in the 1 <sup>st</sup> gain [P2.00~P2.04]																		
1	2 <sup>nd</sup> gain fixed	Be fixed in the 2 <sup>nd</sup> gain fixed [P2.05~P2.09]																		
2	Switching input with gain	Invalid: the 1 <sup>st</sup> gain Valid: the 2 <sup>nd</sup> gain																		

3	Torque command	<p>In the previous 1<sup>st</sup> gain, if the absolute value of the torque command exceed, it will switch to the 2<sup>nd</sup> gain</p> <p>In the previous 2<sup>nd</sup> gain, if the absolute value of the torque command last in the delay time, it will return to the 1<sup>st</sup> gain</p>
---	----------------	---

**Note:**The parameter is invalid to the position gain. The actual position gain is the 1st gain.

P2.31	Data	16bit	Data format	DEC
	Modbus communication address	1462,1463	CANopen communication address	0x221F,0x00

P2.32	Delay time of torque control switching	Setting range	Default	Unit	Available mode			
		0~10000	0	ms			T	

In the torque control, if set P2.31 to be 3, when switch from the 2<sup>nd</sup> gain to the 1<sup>st</sup> gain, it is the time from meeting the trigger conditions to the actual switching.

P2.32	Data	16bit	Data format	DEC
	Modbus communication address	1464,1465	CANopen communication address	0x2220,0x00

P2.33	Switching level of torque control	Setting range	Default	Unit	Available mode			
		0~20000	0	To the mode			T	

In the torque control, if set P2.31 to be 3, it is necessary to set switching conditions. The unit will be different to the mode and setting.

**Note:** Please set the degree  $\geq$  the delay

P2.33	Data	16bit	Data format	DEC
	Modbus communication address	1466,1467	CANopen communication address	0x2221,0x00

P2.34	Switching delay of the torque control	Setting range	Default	Unit	Available mode			
		0~20000	0	To the			T	

				mode				
<p>In the torque control, if set P2.31 to be 3, it is necessary to set switching conditions. The unit will be different to the mode and setting.</p> <p><b>Note:</b> Please set the degree&lt;the delay, in the actual application, the delay=the degree</p>								
P2.34	Data	16bit	Data format	DEC				
	Modbus communication address	1468,1469	CANopen communication address	0x2222,0x00				

**6.3.3 Special motor control**

P2.42	Gain compensation of disturbance torque	Setting range	Default	Unit	Available mode			
		0.0~100.0	0.0	%	P	S		F
<p>This parameter is used to set the gain compensation of disturbance torque. Increasing the gain may control more disturbances. It is necessary to be used with P2.43 to find the best setting point. After setting P2.43, please increase the setting value of P2.42.</p>								
P2.42	Data	16bit	Data format	DEC				
	Modbus communication address	1484,1485	CANopen communication address	0x222A,0x00				

P2.43	Filter time of the disturbance observer	Setting range	Default	Unit	Available mode			
		0.00~25.00	0.53	ms	P	S		F
<p>This parameter is used to set the filter time of the disturbance observer.</p>								
P2.43	Data	16bit	Data format	DEC				
	Modbus communication address	1486,1487	CANopen communication address	0x222B,0x00				

P2.44	Torque command offset	Setting range	Default	Unit	Available mode			
		-500.0~500.0	0.0	%	P	S		F
<p>This parameter is used to set the changing load compensation which is added to the torque command. It is usually be used in the vertical shaft application and other control modes except</p>								

for the torque control mode.				
P2.44	Data	16bit	Data format	DEC
	Modbus communication address	1488,1489	CANopen communication address	0x222C,0x00

P2.45	Friction compensation of forward torque	Setting range	Default	Unit	Available mode			
		-500.0~500.0	0.0	%	P	S		F

This parameter is used to set the friction compensation of torque command when the device receives forward command.

P2.45	Data	16bit	Data format	DEC
	Modbus communication address	1490,1491	CANopen communication address	0x222D,0x00

P2.46	Friction compensation of negative torque	Setting range	Default	Unit	Available mode			
		-500.0~500.0	0.0	%	P	S		F

This parameter is used to set the friction compensation of torque command when the device receives reverse command.

P2.46	Data	16bit	Data format	DEC
	Modbus communication address	1492,1493	CANopen communication address	0x222E,0x00

P2.47*	Factor setting of alveolar pulsating torque compensation	Setting range	Default	Unit	Available mode			
		0~1	0	-	P	S		F

This parameter is used to set the factor setting of alveolar pulsating torque compensation.

**Note:** When adjusting, the motor needs to run without load and after adjusting, the motor will run at two directions for a certain time (about 1 minute) and then stop.

P2.47*	Data	16bit	Data format	DEC
	Modbus communication address	1494,1495	CANopen communication address	0x222F,0x00

	address		address	
--	---------	--	---------	--

P2.48	Gain of alveolar pulsating torque compensation	Setting range	Default	Unit	Available mode			
		0~100.0	0.0	%	P	S		F

This parameter is used to set the gain of alveolar pulsating torque compensation. After the factor setting, the parameter is set to 100% automatically.

**Note:** If this function is not needed, it can be set to 0.

P2.48	Data	16bit	Data format	DEC			
	Modbus communication address	1496,1497	CANopen communication address	0x2230,0x00			

P2.60	Validation of the speed observer	Setting range	Default	Unit	Available mode			
		0~2	0	-	P	S	T	F

This parameter is used to set the validation of the speed observer and select the mode.

Setting value	Function
<b>【0】</b>	Disabled
1	Enable the original speed observer
2	Enable the differential speed observer

P2.60	Data	16bit	Data format	DEC			
	Modbus communication address	1520,1521	CANopen communication address	0x223C,0x00			

P2.61	Gain of the speed observer	Setting range	Default	Unit	Available mode			
		1~500	100	Hz	P	S	T	F

This parameter is used to set the gain of the speed observer. Increasing the setting value may increase the response speed of the actual speed, but the vibration and noise may be raised too.

P2.61	Data	16bit	Data format	DEC			
	Modbus communication address	1522,1523	CANopen communication address	0x223D,0x00			

	address		address	
--	---------	--	---------	--

	P2.62	Gain of the phase comparator	Setting range	Default	Unit	Available mode			
			0~1000			100	%	P	S

This parameter is used to set the gain of the phase comparator and adjust the identification error caused by incorrect inertia setting.

**Note:** This value is set to as 100 when P1.02 is set correctly.

P2.62	Data	16bit	Data format	DEC
	Modbus communication address	1524,1525	CANopen communication address	0x223E,0x00

	P2.63	Time constant of the torque filter	Setting range	Default	Unit	Available mode			
			0~65535			100	0.01ms	P	S

This parameter is used to set the time constant of the torque filter.

P2.63	Data	16bit	Data format	DEC
	Modbus communication address	1526,1527	CANopen communication address	0x223F,0x00

	P2.70	The absolute value encoder speed mode	Setting range	Default	Unit	Available mode			
			0~1			0	-	P	S

This parameter is used to set the speed feedback calculation mode when using absolute encoder.

Setting value	Function
<b>【0】</b>	Direct
1	Indirect

**Note:** 1. When it is 1, it can be used with P2.71 to adjust the bandwidth of the internal filter;  
 2. When it is 1, the speed range and noise which is lower than 0 can be available in low rigid setting.

P2.70	Data	16bit	Data format	DEC
-------	------	-------	-------------	-----

	Modbus communication address	1540,1541	CANopen communication address	0x2246,0x00
--	------------------------------	-----------	-------------------------------	-------------

P2.71	Filter level of absolute encoder	Setting range	Default	Unit	Available mode			
		0~6	0	-	P	S	T	F

When P2.70 is set to 1, the filter level can be adjusted and the filter cutting frequency is higher if the setting value is bigger.

**Note:** This parameter is independent from P2.03 and P2.08. The filter level can be changed manually according to the actual operation.

P2.71	Data	16bit	Data format	DEC
	Modbus communication address	1542,1543	CANopen communication address	0x2247,0x00

## 6.4 I/O management parameters (P3)

### 6.4.1 Digital input/output

P3.00 <sup>1</sup>	Configuration 1 of digital input	Setting range	Default	Unit	Available mode			
		0x000~0x11E	0x003	-	P	S	T	F

This parameter is used to select the configuration of the digital value 1. It is a binary number.

0x \* — : \* means the valid bit of the input electric level: 1: High valid; 0: Low valid

0x — \* \* : \* \* means the selected function, the detailed information is as below:

Single name	Sign	Setting value		Available mode			
		High valid	Low valid				
Invalid	—	0x100	0x000	P	S	T	F
Forward direction drive disabled	POT	0x101	0x001	P	S	T	F
Reverse direction drive disabled	NOT	0x102	0x002	P	S	T	F
Servo enabling	SON	0x103	0x003	P	S	T	F
Alarm clearing	CLA	0x104	0x004	P	S	T	F
Control mode switching	MCH	0x105	0x005	P	S	T	

Gain switching	PLC	0x106	0x006	P	S	T	F
Retention pulse clear	RPC	0x107	0x007	P			F
Command pulse prohibited	PLL	0x108	0x008	P			F
Torque limit switch	TLC	0x109	0x009	P	S		F
Internal speed command 1	SPD1	0x10A	0x00A		S		
Internal speed command 2	SPD2	0x10B	0x00B		S		
Internal speed command 3	SPD3	0x10C	0x00C		S		
Zero speed clamp	ZRS	0x10D	0x00D		S	T	
Speed command sign	S-SIGN	0x10E	0x00E		S		
Torque command sign	T-SIGN	0x10F	0x00F			T	
Internal position command 1	POS1	0x110	0x010	P			
Internal position command 2	POS2	0x111	0x011	P			
Internal position command 3	POS3	0x112	0x012	P			
Internal position command 4	POS4	0x113	0x013	P			
External fault	EXT	0x114	0x014	P	S	T	F
Inertia ratio switching	JC	0x115	0x015	P	S	T	F
E-stop	EMG	0x116	0x016	P	S	T	F
HOME switch input	HOME	0x117	0x017	P			
HOME trigger	HTRG	0x118	0x018	P			
Molecule 1 of electronic gear ratio	SC1	0x119	0x019	P			F
Molecule 2 of electronic gear ratio	SC2	0x11A	0x01A	P			F
Bit control trigger	TRIG	0x11B	0x01B	P			
The vibration control switch input	VS-SEL	0x11C	0x01C	P			F



	Fast stop	Q-STOP	0x11D	0x01D	P	S	T	F
	Bit control stop	PTP-ST	0x11E	0x01E	P			

**Note:** The default value in factory is the function of position mode.

P3.00 <sup>1</sup>	Data	16bit	Data format	HEX
	Modbus communication address	1600,1601	CANopen communication address	0x2300, 0x00

P3.01 <sup>1</sup>	Configuration 2 of digital input	Setting range	Default	Unit	Available mode			
		0x000~0x11E	0x00D	-	P	S	T	F
P3.02 <sup>1</sup>	Configuration 3 of digital input	Setting range	Default	Unit	Available mode			
		0x000~0x11E	0x004	-	P	S	T	F
P3.03 <sup>1</sup>	Configuration 4 of digital input	Setting range	Default	Unit	Available mode			
		0x000~0x11E	0x016	-	P	S	T	F
P3.04 <sup>1</sup>	Configuration 5 of digital input	Setting range	Default	Unit	Available mode			
		0x000~0x11E	0x019	-	P	S	T	F
P3.05 <sup>1</sup>	Configuration 6 of digital input	Setting range	Default	Unit	Available mode			
		0x000~0x11E	0x01A	-	P	S	T	F
P3.06 <sup>1</sup>	Configuration 7 of digital input	Setting range	Default	Unit	Available mode			
		0x000~0x11E	0x001	-	P	S	T	F
P3.07 <sup>1</sup>	Configuration 8 of digital input	Setting range	Default	Unit	Available mode			
		0x000~0x11E	0x002	-	P	S	T	F
P3.08 <sup>1</sup>	Configuration 9 of digital input	Setting range	Default	Unit	Available mode			
		0x000~0x11E	0x007	-	P	S	T	F
P3.09 <sup>1</sup>	Configuration 10 of digital input	Setting range	Default	Unit	Available mode			
		0x000~0x11E	0x008	-	P	S	T	F

These parameters are used to set the input function of digital value 2~10, and they are hex numbers.

The setting method is the same as P3.00.

**Note:** The default value in factory is the function of position mode.

P3.01 <sup>1</sup>	Data	16bit	Data format	HEX
	Modbus communication address	1602, 1603	CANopen communication address	0x2301, 0x00

P3.02 <sup>1</sup>	Data	16bit	Data format	HEX
	Modbus communication address	1604, 1605	CANopen communication address	0x2302, 0x00
P3.03 <sup>1</sup>	Data	16bit	Data format	HEX
	Modbus communication address	1606, 1607	CANopen communication address	0x2303, 0x00
P3.04 <sup>1</sup>	Data	16bit	Data format	HEX
	Modbus communication address	1608, 1609	CANopen communication address	0x2304, 0x00
P3.05 <sup>1</sup>	Data	16bit	Data format	HEX
	Modbus communication address	1610, 1611	CANopen communication address	0x2305, 0x00
P3.06 <sup>1</sup>	Data	16bit	Data format	HEX
	Modbus communication address	1612, 1613	CANopen communication address	0x2306, 0x00
P3.07 <sup>1</sup>	Data	16bit	Data format	HEX
	Modbus communication address	1614, 1615	CANopen communication address	0x2307, 0x00
P3.08 <sup>1</sup>	Data	16bit	Data format	HEX
	Modbus communication address	1616, 1617	CANopen communication address	0x2308, 0x00
P3.09 <sup>1</sup>	Data	16bit	Data format	HEX
	Modbus communication address	1618, 1619	CANopen communication address	0x2309, 0x00

P3.10 <sup>1</sup>	Output configuration of digital value 1	Setting range	Default	Unit	Available mode			
		0x000~0x110	0x001	-	P	S	T	F

This parameter is used to select the configuration of the digital value 1. It is a binary number.

0x \* —: \* means the valid bit of the input electric level: 1: High valid; 0: Low valid

0x— \* \*: \* \* means the selected function, the detailed information is as below:

Single name	Sign	Setting value		Setting value			
		High valid	Low valid				
Invalid	—	0x100	0x000	P	S	T	F
Servo ready output	RDY	0x101	0x001	P	S	T	F
Servo operation output	RUN	0x102	0x002	P	S	T	F
Fault output	ALM	0x103	0x003	P	S	T	F
Reserved	RSV	0x104	0x004	P	S	T	F
External brake signals clear	BRK	0x105	0x005	P	S	T	F
Position command or not	PCMD	0x106	0x006	P			F
Positioning finished	PLR	0x107	0x007	P			F
Control mode switch state	MCHS	0x108	0x008	P	S	T	
Speed matching	COIN	0x109	0x009		S	T	
Speed arrival	SR	0x10A	0x00A		S	T	
Speed limiting	SL	0x10B	0x00B	P	S	T	
Speed command or not	SCMD	0x10C	0x00C		S		
Speed zero output	ZSO	0x10D	0x00D	P	S	T	F
Torque limiting	LM	0x10E	0x00E	P	S	T	F
Zeroing finished	HEND	0x10F	0x00F	P			
Torque arrival	TRCH	0x110	0x010			T	

**Note:** The default value in factory is the function of position mode.

P3.10 <sup>1</sup>	Data	16bit	Data format	HEX
	Modbus communication address	1620,1621	CANopen communication address	0x230A, 0x00

P3.11 <sup>1</sup>	Output configuration of digital value 2	Setting range	Default	Unit	Available mode			
		0x000~0x110	0x003	-	P	S	T	F
P3.12 <sup>1</sup>	Output configuration of digital value 3	Setting range	Default	Unit	Available mode			
		0x000~0x110	0x007	-	P	S	T	F
P3.13 <sup>1</sup>	Output configuration of digital value 4	Setting range	Default	Unit	Available mode			
		0x000~0x110	0x00D	-	P	S	T	F
P3.14 <sup>1</sup>	Output configuration of digital value 5	Setting range	Default	Unit	Available mode			
		0x000~0x110	0x005	-	P	S	T	F
P3.15 <sup>1</sup>	Output configuration of digital value 6	Setting range	Default	Unit	Available mode			
		0x000~0x110	0x00E	-	P	S	T	F

These parameters are used to set the output function of digital value 2~10, and they are hex numbers.

The setting method is the same as P3.10.

**Note:** The default value in factory is the function of position mode.

P3.11 <sup>1</sup>	Data	16bit	Data format	HEX
	Modbus communication address	1622, 1623	CANopen communication address	0x230B, 0x00
P3.12 <sup>1</sup>	Data	16bit	Data format	HEX
	Modbus communication address	1624, 1625	CANopen communication address	0x230C, 0x00
P3.13 <sup>1</sup>	Data	16bit	Data format	HEX
	Modbus communication address	1626, 1627	CANopen communication address	0x230D, 0x00
P3.14 <sup>1</sup>	Data	16bit	Data format	HEX
	Modbus communication address	1628, 1629	CANopen communication address	0x230E, 0x00
P3.15 <sup>1</sup>	Data	16bit	Data format	HEX
	Modbus communication address	1630, 1631	CANopen communication address	0x230F, 0x00

### 6.4.2 Analog input / output adjustment

	P3.20	Offset of analog speed command	Setting range	Default	Unit	Available mode		
			-10.000~10.000	0.000	V	S		

This parameter can be used to adjust the analog speed command to improve the effective accuracy for the analog input.

Due to zero drift of the AI devices and other reasons, the actual AI corresponding value may deviate from the expected value. At this time it can be eliminated by setting the offset of AI.

The meaning of the analog offset voltage is shown in the figure as below:

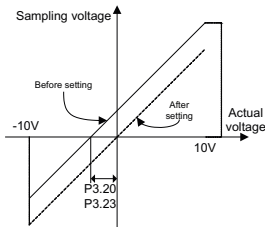

For example, after the analog setting signal is connected into the analog speed command terminal of the drive, even though the analog setting signal is 0, the front panel displays the analog speed command voltage (R1.05) is 0.02V. On this condition, parameter P3.20 should be set as 0.02. The drive will automatically subtract 0.02V from the analog speed command value received. If the front panel displays the analog speed command voltage is -0.02V, parameter P3.20 should be set as -0.02. The drive will automatically add 0.02V to the analog speed command value received.

P3.20	Data	32bit	Data format	DEC
	Modbus communication address	1640,1641	CANopen communication address	0x2314,0x00

	P3.21	Filter of analog speed command	Setting range	Default	Unit	Available mode		
			0.0~1000.0	0.0	ms	S		

This parameter is used to set the time constant of the filter of analog speed command. Setting this parameter can smooth the speed changing when the speed analog input is large. As the figure below:

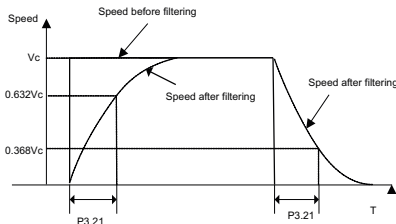

P3.21	Data	16bit	Data format	DEC
	Modbus communication address	1642,1643	CANopen communication address	0x2315,0x00

P3.22	Voltage protection of analog speed command	Setting range	Default	Unit	Available mode		
		0.000~10.000	0.000	V	S		

This parameter is used to set the voltage protection of analog speed command. If the absolute value of R1.05 exceeds the setting value, the system will report fault.

- Note:** 1. The default value of 0 means no undervoltage protection;  
 2. The input voltage can be less than 10V, otherwise damage may occur to the drive.

P3.22	Data	32bit	Data format	DEC
	Modbus communication address	1644,1645	CANopen communication address	0x2316,0x00

P3.23	Offset of analog torque command	Setting range	Default	Unit	Available mode			
		-10.000~10.000	0.000	V	P	S	T	F

This parameter can be used to adjust the torque command to improve the effective accuracy for the analog input.

The setting method is the same as P3.20.

P3.23	Data	32bit	Data format	DEC
	Modbus communication address	1646,1647	CANopen communication address	0x2317,0x00

P3.24	Filter of analog torque command	Setting range	Default	Unit	Available mode			
		0.0~1000.0	0.0	ms	P	S	T	F
<p>This parameter is used to set the time constant of the filter of analog torque command. Setting this parameter can smooth the changing when the torque analog input is large. As the figure below:</p>								
P3.24	Data	16bit	Data format	DEC				
	Modbus communication address	1648,1649	CANopen communication address	0x2318,0x00				

P3.25	Voltage protection of analog torque command	Setting range	Default	Unit	Available mode			
		0.000~10.000	0.000	V	P	S	T	F
<p>This parameter is used to set the voltage protection of analog torque command.</p> <p><b>Note:</b></p> <ol style="list-style-type: none"> <li>The default value of 0 means no undervoltage protection;</li> <li>The input voltage can be less than 10V, otherwise damage may occur to the drive.</li> </ol>								
P3.25	Data	32bit	Data format	DEC				
	Modbus communication address	1650,1651	CANopen communication address	0x2319,0x00				

P3.30 <sup>1</sup>	AO 1 selection	Setting range	Default	Unit	Available mode			
		0~19	0	-	P	S	T	F
P3.32 <sup>1</sup>	AO 2 selection	Setting range	Default	Unit	Available mode			
		0~19	0	-	P	S	T	F

This group of parameters is used to select the monitoring parameters to be outputted in analog form.

Setting value	Definition	Unit
<b>【0】</b>	Invalid	-
1	Motor speed	r/min
2	Speed of position command	r/min
3	Internal position command	pulse(Encoder unit)
	Speed command	r/min
5	Torque command	0.1%
6	Torque feedback	0.1%
	Command position deviation	pulse(User unit)
8	Encoder position deviation	pulse(Encoder unit)
9	Full closed-loop position deviation	pulse(Grating ruler unit)
10	Hybrid control deviation	pulse(User unit)
11	The main circuit DC voltage	V
12	Positive torque limit	0.1%
13	Negative torque limit	0.1%
14	Speed limit value	r/min
15	Inertia ratio	%
16	Analog speed command*	V
17	Analog torque command*	V
18	Analog input 3*	V
19	Drive temperature	℃

**Note:** Adjust P3.33 to set the corresponding analog output signal.

P3.30 <sup>1</sup>	Data	16bit	Data format	DEC
	Modbus communication address	1660, 1661	CANopen communication address	0x231E, 0x00
P3.32 <sup>1</sup>	Data	16bit	Data format	DEC
	Modbus communication address	1664, 1665	CANopen communication address	0x2320, 0x00



P3.31	Voltage gain of AO 1	Setting range	Default	Unit	Available mode			
		0~214748364	0	[P3.30 Unit]/V	P	S	T	F
P3.33	Voltage gain of AO 2	Setting range	Default	Unit	Available mode			
		0~214748364	0	[P3.32 Unit]/V	P	S	T	F

These parameters are used to set the gain of analog output. The detailed unit is relative to P3.30 and P3.32.

**Example:** On this condition, set P3.30=1, P3.31=300, the relationship between the actual speed setting and the output voltage is shown in the figure as below:

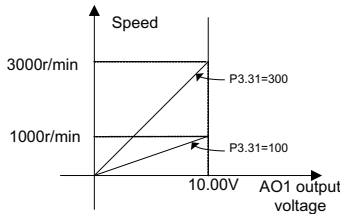

**Note:**

1. If the actual output speed is more than 3000r/min, AO1 output is 10V. Please select the gain according to the actual range.
2. When P3.30 and P3.32 select other functions, the gain setting is the same.

P3.31	Data	32bit	Data format	DEC
	Modbus communication address	1662, 1663	CANopen communication address	0x231F, 0x00
P3.33	Data	32bit	Data format	DEC
	Modbus communication address	1666, 1667	CANopen communication address	0x2321, 0x00

P3.34	Offset voltage of AO1	Setting range	Default	Unit	Available mode			
		-10.000~10.000	0.000	V	P	S	T	F
P3.35	Offset voltage of AO2	Setting range	Default	Unit	Available mode			
		-10.000~10.000	0.000	V	P	S	T	F

This parameter can be used to adjust the AO1 and AO2 to improve the effective accuracy for the analog input.

Actual value of analog output voltage = Original value of analog output voltage + Offset value of analog output voltage

P3.34	Data	32bit	Data format	DEC
	Modbus communication address	1668,1669	CANopen communication address	0x2322,0x00
P3.35	Data	32bit	Data format	DEC
	Modbus communication address	1670,1671	CANopen communication address	0x2323,0x00

P3.36 <sup>1</sup>	Analog output monitor setting	Setting range	Default	Unit	Available mode			
		0~2	0	-	P	S	T	F

This parameter is used to set the output mode and voltage range of the analog output.

Setting value	Output mode
<b>【0】</b>	Voltage output with sign(-10V~10V)
1	Absolute voltage output (0V~10V)
2	Voltage output with zero offset (0V~10V, 5V center)

P3.36 <sup>1</sup>	Data	16bit	Data format	DEC
	Modbus communication address	1672,1673	CANopen communication address	0x2324,0x00

### 6.4.3 Switch input / output settings

P3.40 <sup>1</sup>	Travel limit switch shield	Setting range	Default	Unit	Available mode			
		0~2	1	-	P	S	T	F

This parameter is used to set the input signals of the forward travel limit terminal (0x001 or 0x101) and reverse travel limit terminal (0x002 or 0x102) of P3.00~P3.09 are active or inactive.

If the function of the travel limit switch needs to be shielded, set this parameter.

Setting value	Function
0	Signals of the travel limit terminals are normal
<b>【1】</b>	Signals of the travel limit terminals are disabled
2	Travel limit fault

If the travel limit alarm takes effective, the reverse command will be sent to the drive, and then the motor will be out of the travel limit zone and report the automatic clearance of the alarm.

P3.40 <sup>1</sup>	Data	16bit	Data format	DEC
	Modbus communication address	1680,1681	CANopen communication address	0x2328,0x00

P3.41 <sup>1</sup>	E-stop shield	Setting range	Default	Unit	Available mode			
		0~1	0	-	P	S	T	F

This parameter is used to set the configuration of P3.00~P3.09 of the emergency stop terminal (0x016 or 0x116) is valid or invalid. If the function of the E-stop needs to be shielded, set this parameter.

Setting value	Function
0	Signal of the emergency stop terminal is valid
【1】	Signal of the emergency stop terminal is invalid

If the terminal is digital input is valid, then Er10-4 will occur.

**Note:**

1. If Er10-4 occurs, the servo drive will stop at the stopping mode set by P4.30.
2. The clearance of Er10-4: Please ensure there is no danger, and then clear the alarm signal (i.e. connecting EMG with COM). If the alarm is displayed to be cleared (CLA function), it is necessary to enable the servo drive again, and the system will work normally.

P3.41 <sup>1</sup>	Data	16bit	Data format	DEC
	Modbus communication address	1682,1683	CANopen communication address	0x2329,0x00

P3.43 <sup>1</sup>	Digital input filter	Setting range	Default	Unit	Available mode			
		1~8	1	0.125ms	P	S	T	F

This parameter is used to set the filter time of the digital input.

**Note:** The parameter works alone for 10 digital input.

P3.43 <sup>1</sup>	Data	16bit	Data format	DEC
	Modbus	1686,1687	CANopen	0x232B,0x00

	communication address		communication address	
--	-----------------------	--	-----------------------	--

P3.44	Command pulse input invalid setting disabled	Setting range	Default	Unit	Available mode		
		0~1	0	-	P		F

This parameter can set the digital input of command pulse input disabled (0x008 or 0x108) is valid or not. If the function needs to be shielded, it is necessary to set this parameter.

0:Valid

1:Invalid

P3.44	Data	16bit	Data format	DEC
	Modbus communication address	1688,1689	CANopen communication address	0x232C,0x00

P3.45 <sup>1</sup>	Clear mode of retention pulse	Setting range	Default	Unit	Available mode		
		0~1	1	-	P		F

This parameter can set the valid mode of digital input of retention pulse (0x007 or 0x107).

Setting value	Function
0	ON Level clear
<b>【1】</b>	Rising edge clear

P3.45 <sup>1</sup>	Data	16bit	Data format	DEC
	Modbus communication address	1690,1691	CANopen communication address	0x232D,0x00

P3.50	Range of position reaching	Setting range	Default	Unit	Available mode		
		0~262144	100	pulse	P		F

This parameter is used to set the range of position reaching. When the deviation between the position feedback pulse and position command pulse are in this range, it is considered that it has reached the position.

P3.50	Data	32bit	Data format	DEC
-------	------	-------	-------------	-----

	Modbus communication address	1700,1701	CANopen communication address	0x2332,0x00
--	------------------------------	-----------	-------------------------------	-------------

P3.51	Output mode of position reaching	Setting range	Default	Unit	Available mode		
		0~3	0	-	P		F

This parameter can be used to set the condition and action mode of the position reaching signal.

Setting value	Output mode
<b>【0】</b>	Output valid if the position deviation is between the range of P3.50
1	No position command, and output valid if the position deviation is between the range of P3.50
2	No position command, valid zero speed test signal and output valid if the position deviation is between the range of P3.50
3	From the position command to no position command and output valid if the position deviation is between the range of P3.50. And then, last the valid state to the time of P3.52, after that, updates the position to the output state according to the position command and the position deviation

P3.51	Data	16bit	Data format	DEC
	Modbus communication address	1702,1703	CANopen communication address	0x2333,0x00

P3.52	Retention time of position reaching output terminal	Setting range	Default	Unit	Available mode		
		0~30000	0	ms	P		F

This parameter is used to set the retention time of position reaching output terminal.				
	Setting value	Action		
	【0】	Retention time is infinite, and last valid to the next position command position		
	1~30000	Only valid during the setting value and during the retention, if receive the position command, it will change to invalid state		
P3.52	Data	16bit	Data format	DEC
	Modbus communication address	1704,1705	CANopen communication address	0x2334,0x00

	P3.53	Speed matching range	Setting range	Default	Unit	Available mode				
			10~20000	50	r/min	P	S	T	F	
<p>This parameter is used to set the test condition of speed matching output.</p> <p>If the difference between the speed command and the motor speed is in the setting value, then the output state of the speed matching is valid.</p> <p>The threshold of the speed matching when there is 10r/min lag:                  Speed matching output: Invalid -&gt;Valid threshold: (P3.53 – 10)r/min                  Valid -&gt; The critical value of invalid: (P3.53 + 10) r/min</p>										
P3.53	Data	16bit	Data format	DEC						
	Modbus communication address	1706,1707	CANopen communication address	0x2335,0x00						

	P3.54	Speed reaching range	Setting range	Default	Unit	Available mode				
			10~20000	1000	r/min	P	S	T	F	
<p>This parameter is used to set the speed reaching range. If the instant motor speed reached the setting value, the output is valid. There is 10r/min lag.</p>										
P3.54	Data	16bit	Data format	DEC						
	Modbus communication address	1708,1709	CANopen communication address	0x2336,0x00						

	P3.55	Zero speed range	Setting range	Default	Unit	Available mode				
			10~20000	50	r/min	P	S	T	F	
This parameter is used to set the zero speed range. If the absolute value of instant motor speed is the setting value, the output is valid. There is 10r/min lag.										
P3.55	Data	16bit	Data format	DEC						
	Modbus communication address	1710,1711	CANopen communication address	0x2337,0x00						

	P3.56	Locked time of servo after braking	Setting range	Default	Unit	Available mode				
			0~1000	50	ms	P	S	T	F	
This parameter is used to set the locked time of the servo after braking in the locked state. The servo is OFF in the locked state, the output transistor of the brake releasing terminal (0x005 or 0x105) signal turns off. At this time, the servo will continue to be locked for a period of time so that the motor will not rotate during the action of the relay.										
P3.56	Data	16bit	Data format	DEC						
	Modbus communication address	1712,1713	CANopen communication address	0x2338,0x00						

	P3.57	Braking delay time of the electromagnetic brake	Setting range	Default	Unit	Available mode				
			0~30000	500	ms	P	S	T	F	
This parameter is used to set the braking delay time of the electromagnetic brake. The servo is OFF or an alarm occurs in the running state, in this condition, the speed may be relatively high, so the output transistor of the brake releasing terminal (0x005 or 0x105) signal can be turned off after a delay time. If the speed falls below P3.58 within the delay time, the output transistor of the BRK signal will be turned off ahead of time.										
P3.57	Data	16bit	Data format	DEC						
	Modbus communication address	1714,1715	CANopen communication address	0x2339,0x00						

	P3.58 <sup>1</sup>	Motor speed when brake clear	Setting range	Default	Unit	Available mode				
			0~1000	30	r/min	P	S	T	F	
This parameter is used to set the motor speed when brake clears.										
P3.58 <sup>1</sup>	Data	16bit	Data format		DEC					
	Modbus communication address	1716,1717	CANopen communication address		0x233A,0x00					

	P3.59	Torque arriving range	Setting range	Default	Unit	Available mode				
			5~300	50	%			T		
This parameter is used to set the torque arriving range. If the motor torque feedback exceeds this setting value, the output is valid and there is 5% lag.										
P3.59	Data	16bit	Data format		DEC					
	Modbus communication address	1718,1719	CANopen communication address		0x233B,0x00					

	P3.90	Pulse input filter	Setting range	Default	Unit	Available mode				
			0~5	2	-	P	S	T	F	
This parameter is used to set filter time of the pulse input.										
		Setting value	Width of pulse input							
		0	400kHz							
		1	500kHz							
		<b>【2】</b>	1MHz							
		3	2MHz							
		4	4MHz							
		5	>4MHz							
P3.90	Data	16bit	Data format		DEC					
	Modbus	1780,1781	CANopen		0x235A,0x00					



	communication address		communication address	
--	-----------------------	--	-----------------------	--

**6.4.4 Analog input 3 adjustment**

	P3.70 <sup>1</sup>	Analog input 3 function	Setting range	Default	Unit	Available mode			
			0~3	2	-	P	S	T	F

This parameter is used to set the function of analog input 3.

Setting value	Definition	Unit
<b>【0】</b>	Invalid	-
1	Speed limit	r/min
2	Torque limit <sup>*1</sup>	%
3	Speed command <sup>*2</sup>	r/min

**Note:** <sup>\*1</sup> If P3.70 is 2 and P0.09 is 0 or 4, the analog input 3 corresponds to the negative torque limit and parameters of P0.62~P0.65,P3.23~P3.25 correspond to the negative torque limit.

<sup>\*2</sup> If P3.70 is 3, P0.42~P0.45,P3.20~P3.22 are invalid.

P3.70 <sup>1</sup>	Data	16bit	Data format	DEC
	Modbus communication address	1740,1741	CANopen communication address	0x2346,0x00

	P3.71	Analog input 3 zero drift	Setting range	Default	Unit	Available mode			
			-10.000~10.000	0.000	V	P	S	T	F

The voltage of analog input 3 zero drift.

P3.71	Data	32bit	Data format	DEC
	Modbus communication address	1742,1743	CANopen communication address	0x2347,0x00

	P3.72	Analog input 3 dead zone	Setting range	Default	Unit	Available mode			
			0.000~3.000	0.000	V	P	S	T	F

Analog input 3 dead zone.

P3.72	Data	16bit	Data format	DEC
	Modbus communication address	1744,1745	CANopen communication address	0x2348,0x00

P3.73	Analog input 3 gain	Setting range	Default	Unit	Available mode			
		0~2000	300	-	P	S	T	F

This parameter is used to set the analog input 3 gain and the corresponding function is as below:

P3.70Setting value	Definition	P3.73 unit
<b>【0】</b>	Invalid	-
1	Speed limit	(r/min)/V
2	Torque limit <sup>*1</sup>	0.1%/V
3	Speed command <sup>*2</sup>	(r/min)/V

P3.73	Data	32bit	Data format	DEC
	Modbus communication address	1746,1747	CANopen communication address	0x2349,0x00

P3.74	Analog input 3 reverse	Setting range	Default	Unit	Available mode			
		0~1	0	-	P	S	T	F

This parameter is used to set the voltage polarity of analog input 3.

Setting value	Detection result	
<b>【0】</b>	Positive polarity	[+voltage] -> [positive],[ - voltage] -> [negative]
1	Negative polarity	[+voltage] -> [negative],[ - voltage] -> [positive]

P3.74	Data	16bit	Data format	DEC
	Modbus communication address	1748,1749	CANopen communication address	0x234A,0x00

	address		address	
--	---------	--	---------	--

	P3.75	Analog input 3 voltage protection	Setting range	Default	Unit	Available mode				
			0.000~10.000	0.000	V	P	S	T	F	
This parameter is used to set the voltage protection of analog input 3. If the absolute value of the voltage exceeds the setting value, the system will report alarm.										
P3.75	Data	32bit	Data format	DEC						
	Modbus communication address	1750,1751	CANopen communication address	0x234B,0x00						

	P3.76	Analog input 3 filter	Setting range	Default	Unit	Available mode				
			0.0~1000.0	0.0	ms	P	S	T	F	
This parameter is used to set the filter time constant of the analog input 3.										
P3.76	Data	16bit	Data format	DEC						
	Modbus communication address	1752,1753	CANopen communication address	0x234C,0x00						

## 6.5 Extension and application (P4)

### 6.5.1 Communication setting

	P4.01 <sup>1</sup>	485 local communication address	Setting range	Default	Unit	Available mode				
			1~255	1	-	P	S	T	F	
This parameter is used to set the local (slave) communication address of the 485 serial communication.										
P4.01 <sup>1</sup>	Data	16bit	Data format	DEC						
	Modbus communication address	1802,1803	CANopen communication address	0x2401, 0x00						

	P4.02 <sup>1</sup>	CAN communication baud rate	Setting range	Default	Unit	Available mode			
			0~5	1	-	P	S	T	F

This parameter is used to select the CAN communication baud rate. Available baud rate are as follow:

Setting value	Baud rate
0	1000kbps
<b>【1】</b>	500kbps
2	250kbps
3	125kbps
4	50kbps
5	20kbps

P4.02 <sup>1</sup>	Data	16bit	Data format	DEC
	Modbus communication address	1804,1805	CANopen communication address	0x2402, 0x00

P4.03 <sup>1</sup>	485 communication baud rate	Setting range	Default	Unit	Available mode			
		0~3	1	-	P	S	T	F

This parameter is used to select the 485 communication baud rate. Available baud rate are as follow:

Setting value	Baud rate
0	9600bps
<b>【1】</b>	19200bps
2	38400bps
3	57600bps

P4.03 <sup>1</sup>	Data	16bit	Data format	DEC
	Modbus communication address	1806,1807	CANopen communication address	0x2403,0x00

P4.04 <sup>1</sup>	485 communication parity mode	Setting range	Default	Unit	Available mode			
		0~5	0	-	P	S	T	F

This parameter is used to set the 485 communication parity mode and it is only support RTU mode.

Setting value	Baud rate
<b>【0】</b>	None (8, N, 1)
1	Even (E, 8, 1)
2	Odd (8, O, 1)
3	None(N, 8, 2)
4	Even(E, 8, 2)
5	Odd(O, 8, 2)

P4.04 <sup>1</sup>	Data	16bit	Data format	DEC
	Modbus communication address	1808,1809	CANopen communication address	0x2404,0x00

P4.05 <sup>1</sup>	CAN communication node	Setting range	Default	Unit	Available mode			
		1~127	1	-	P	S	T	F

This parameter is used to set the local (salve) CAN communication node.

P4.05 <sup>1</sup>	Data	16bit	Data format	DEC
	Modbus communication address	1810,1811	CANopen communication address	0x2405,0x00

P4.06	485 communication fault clear mode	Setting range	Default	Unit	Available mode			
		0~1	1	-	P	S	T	F

Set the processing method of the drive at 485 communication fault.

Setting value	Meaning
0	Not clear
<b>【1】</b>	Clear automatically

P4.06	Data	16bit	Data format	DEC
	Modbus	1812, 1813	CANopen	0x2406, 0x00

	communication address		communication address	
--	-----------------------	--	-----------------------	--

	P4.07 <sup>1</sup>	EtherCAT synchronous cycle	Setting range	Default	Unit	Available mode			
			0~3	2	-	P	S	T	F

When EtherCAT communication adopts DC mode, DC sync0 interrupts synchronous cycle.

Setting value	Meaning
0	250us
1	500us
<b>【2】</b>	1ms
3	2ms

P4.07 <sup>1</sup>	Data	16bit	Data format	DEC
	Modbus communication address	1814, 1815	CANopen communication address	0x2407, 0x00

	P4.08 <sup>1</sup>	EtherCAT synchronous type	Setting range	Default	Unit	Available mode			
			0~2	0	-	P	S	T	F

Set the synchronous mode between master station and slave station of EtherCAT communication.

Setting value	Meaning
<b>【0】</b>	Free-run
2	DC mode(sync0)

P4.08 <sup>1</sup>	Data	16bit	Data format	DEC
	Modbus communication address	1816, 1817	CANopen communication address	0x2408, 0x00

	P4.09 <sup>1</sup>	EtherCAT fault detection time	Setting range	Default	Unit	Available mode			
			0~10000	100	ms	P	S	T	F

Set EtherCAT communication fault detection time.

<b>Note:</b> When setting the parameter to 0, do not detect EtherCAT fault.				
P4.09 <sup>1</sup>	Data	16bit	Data format	DEC
	Modbus communication address	1818, 1819	CANopen communication address	0x2409, 0x00

### 6.5.2 Servo type and communication control command

	P4.10 <sup>1</sup>	Upper PC	Setting range	Default	Unit	Available mode			
			0~1	0	-	P	S	T	F

This parameter is used to set the upper PC which is classified by the interface.

Setting value	Upper PC	Control interface
<b>【0】</b>	Pulse + analog	Position control/fully close loop: pulse and bit control Speed control /torque control: analog and internal setting
1	Communication bus	485(protocol: Modbus) CAN(protocol: CANopen CiA301/402) PROFIBUS(protocol: PROFIBUS-DPV0)

P4.10 <sup>1</sup>	Data	16bit	Data format	DEC
	Modbus communication address	1820,1821	CANopen communication address	0x240A,0x00

	P4.11*	Bus servo enabling	Setting range	Default	Unit	Available mode			
			0~1	0	-	P	S	T	F

If P4.10 is 1, this parameter can control the bus servo enabling of the drive.

Setting value	Function
<b>【0】</b>	Disabled
1	Enabled

**Note:** If the drive is enabled by P0.04, and the drive is disabled if P4.11 is from state 1 to state 0.

P4.11*	Data	16bit	Data format	DEC
--------	------	-------	-------------	-----

	Modbus communication address	1822,1823	CANopen communication address	0x240B,0x00
--	------------------------------	-----------	-------------------------------	-------------

	P4.12*	Bus position command	Setting range	Default	Unit	Available mode			
			$-(2^{31}-1)\sim(2^{31}-1)$	0	pulse	P			F

If P4.10 is 1, the bus position command can be set.

P4.12*	Data	32bit	Data format	DEC			
	Modbus communication address	1824,1825	CANopen communication address	0x240C,0x00			

	P4.13*	Bus speed command	Setting range	Default	Unit	Available mode			
			-20000~20000	0	r/min		S		

If P4.10 is 1, the bus speed command can be set.

P4.13*	Data	16bit	Data format	DEC			
	Modbus communication address	1826,1826	CANopen communication address	0x240D,0x00			

	P4.14*	Bus torque command	Setting range	Default	Unit	Available mode			
			-500.0~500.0	0.0	%			T	

If P4.10 is 1, the bus torque command can be set.

P4.14*	Data	16bit	Data format	DEC			
	Modbus communication address	1828,1829	CANopen communication address	0x240E,0x00			

	P4.15*	Switching command of control mode	Setting range	Default	Unit	Available mode			
			0~1	0	-	P	S	T	F



When P4.10 is 1, this parameter can be used to switch the control mode.

Setting value	Function	Actual control mode	
【0】	Disabled	Position/speed	Position
		Position/torque	Position
		Speed/torque	Speed
1	Enabled	Position/speed	Speed
		Position/torque	Torque
		Speed/torque	Torque

**Note:** After the updating of the command, the actual switching process will be carried out according to the setting of P0.90~P.92.

P4.15*	Data	16bit	Data format	DEC
	Modbus communication address	1830,1831	CANopen communication address	0x240F,0x00

P4.16*	Gain switching command	Setting range	Default	Unit	Available mode			
		0~1	0	-	P	S	T	F

If P4.10 is 1, this parameter can be used to set the gain switching command. When P2.22,P2.27,P2.31 is 2, the actual controlled gain setting can be switched.

Setting value	Function	Actual gain
【0】	Disabled	1 <sup>st</sup> gain setting
1	Enabled	2 <sup>nd</sup> gain setting

P4.16*	Data	16bit	Data format	DEC
	Modbus communication address	1832,1833	CANopen communication address	0x2410,0x00

P4.17*	Switching command of electronic gear ratio	Setting range	Default	Unit	Available mode			
		0~3	0	-	P			F

If P4.10 is 1, this parameter can be used to set the switching command of electronic gear ratio.

Setting value	Molecule of actual electronic gear ratio	Denominator of actual electronic gear ratio		
<b>【0】</b>	Molecule of 1 <sup>st</sup> electronic gear ratio(P0.25)	Denominator of electronic gear ratio(P0.26)		
1	Molecule of 2 <sup>nd</sup> electronic gear ratio(P0.27)			
2	Molecule of 3 <sup>rd</sup> electronic gear ratio(P0.28)			
3	Molecule of 4 <sup>th</sup> electronic gear ratio(P0.29)			
P4.17*	Data	16bit	Data format	DEC
	Modbus communication address	1834,1835	CANopen communication address	0x2411,0x00

P4.18*	Inertia ratio switch command	Setting range	Default	Unit	Available mode			
		0~1	0	-	P	S	T	F

If P4.10 is 1, this parameter can be used to set the inertia ratio switch command.

Setting value	Function	Actual inertia ratio
<b>【0】</b>	Disabled	The first inertia ratio (P1.01)
1	Enabled	The second inertia ratio (P1.02)

P4.18*	Data	16bit	Data format	DEC
	Modbus communication address	1836,1837	CANopen communication address	0x2412,0x00

P4.19*	Zero speed clamp command	Setting range	Default	Unit	Available mode			
		0~1	0	-		S	T	

If P4.10 is 1, this parameter can be used to set the zero speed clamp command.

	Setting value	Function		
	<b>【0】</b>	Disabled		
	1	Enabled		
P4.19*	Data	16bit	Data format	DEC
	Modbus communication address	1838,1839	CANopen communication address	0x2413,0x00

P4.20*	Retention pulse clear	Setting range	Default	Unit	Available mode		
		0~1	0	-	P		F
<p>If P4.10 is 1, this parameter can be used to set the retention pulse clear. The detailed mode is determined by P3.45 and after clearing, R0.04 is 0.</p>							
	Setting value	Function					
	<b>【0】</b>	Disabled					
	1	Enabled					
P4.20*	Data	16bit	Data format	DEC			
	Modbus communication address	1840,1841	CANopen communication address	0x2414,0x00			

P4.21*	Torque switching command	Setting range	Default	Unit	Available mode		
		0~1	0	-	P	S	T
<p>If P4.10 is 1, this parameter can be used to set the torque control switching.</p>							
	Setting value	Function					
	<b>【0】</b>	Disabled					
	1	Enabled					
P4.21*	Data	16bit	Data format	DEC			
	Modbus communication address	1842,1843	CANopen communication address	0x2415,0x00			

	address		address	
--	---------	--	---------	--

	P4.22*	External fault command	Setting range	Default	Unit	Available mode			
			0~1	0	-	P	S	T	F

If P4.10 is 1, this parameter can be used to set the external fault command.

Setting value	Function
<b>【0】</b>	Disabled
1	Enabled

P4.22*	Data	16bit	Data format	DEC
	Modbus communication address	1844,1845	CANopen communication address	0x2416,0x00

	P4.23*	E-stop command	Setting range	Default	Unit	Available mode			
			0~1	0	-	P	S	T	F

If P4.10 is 1, this parameter can be used to set E-stop command.

Setting value	Function
<b>【0】</b>	Disabled
1	Enabled

P4.23*	Data	16bit	Data format	DEC
	Modbus communication address	1846,1847	CANopen communication address	0x2417,0x00

	P4.24*	Switch input command of vibration control	Setting range	Default	Unit	Available mode			
			0~1	0	-	P			F

If P4.10 is 1, this parameter can be used to set the switch input command of vibration control.

	Setting value	Function		
	<b>【0】</b>	Disabled		
	1	Enabled		
P4.24*	Data	16bit	Data format	DEC
	Modbus communication address	1848,1849	CANopen communication address	0x2418,0x00

6.5.3 Extension and application

	P4.30	Stop mode	Setting range	Default	Unit	Available mode			
			0~1	0	-	P	S	T	F

When the servo is turned OFF and when an fault alarm occurs, this parameter is used to set whether the dynamic brake works or not as well as the state selection of the servo motor after stop:

P4.30Setting value	Action	
	During deceleration	After stopping
<b>【0】</b>	Coast to stop	Keep the inertia operation state
1	Dynamic brake to stop	Keep the inertia operation state

**Note:** 1. If it is 1 and the motor speed is higher than the setting value of P3.58, it will begin dynamic braking and when it is lower than the setting value of P3.58, the dynamic braking will stop.

2. If the motor speed is higher than the rated speed, do not use the dynamic breaker. If the operation speed is high and with large inertia, please use the dynamic breaker with cautions.

Do not start the dynamic breaker frequently; damage may occur to the servo drive.

P4.30	Data	16bit	Data format	DEC
	Modbus communication address	1860,1861	CANopen communication address	0x241E,0x00

	P4.31	Max speed limit	Setting range	Default	Unit	Available mode			
			0~20000	5000	r/min	P	S	T	F

This parameter can be used to set the highest speed the servo motor can run. If the absolute value of the speed command is larger than the value of this parameter, the magnitude of the actual speed setting will be limited by this parameter; the direction is the same as that of the original speed command. This parameter is active in all modes.

**Note:** The default value of this parameter is related to the power level of the drive.

P4.31	Data	16bit	Data format	DEC
	Modbus communication address	1862,1863	CANopen communication address	0x241F,0x00

P4.32	Overspeed level	Setting range	Default	Unit	Available mode			
		0~20000	6000	r/min	P	S	T	F

This parameter is used to set the overspeed level of the servo motor. When the rotation speed of the motor exceeds this speed setting, an overspeed fault alarm will be reported.

**Note:** The default of this parameter is related to the power level of the drive.

P4.32	Data	16bit	Data format	DEC
	Modbus communication address	1864,1865	CANopen communication address	0x2420,0x00

P4.33	Pulse range for over-position	Setting range	Default	Unit	Available mode			
		0~134217748	100000	pulse	P			F

This parameter is used to set the alarm threshold for the over-position fault (Er22-0). In the position or fully close loop mode, when the number of retention pulses exceeds this setting, an over-position fault alarm will be reported.

P4.33	Data	32bit	Data format	DEC
	Modbus communication address	1866,1867	CANopen communication address	0x2421,0x00

P4.34 <sup>1</sup>	Brake overload detection	Setting range	Default	Unit	Available mode			
		0~2	0	-	P	S	T	F

These parameters are used to set the dynamic braking and overload protection mode.

	Setting value	Dynamic braking and overload protection		
	【0】	Prohibition (no dynamic braking)		
	1	Embedded		
	2	External		
P4.34 <sup>1</sup>	Data	16bit	Data format	DEC
	Modbus communication address	1868,1869	CANopen communication address	0x2422,0x00

P4.36 <sup>1</sup>	Undervoltage protection of the main power supply	Setting range	Default	Unit	Available mode			
		0~1	1	-	P	S	T	F

This parameter is used to set whether the drive will report the alarm when undervoltage occurs to the main power supply.

	Setting value	Protection		
	0	Not to display the undervoltage fault of the main circuit (Er13-1)		
	【1】	Display the undervoltage fault of the main circuit (Er13-1) and stop		
P4.36 <sup>1</sup>	Data	16bit	Data format	DEC
	Modbus communication address	1872,1873	CANopen communication address	0x2424,0x00

P4.37	Undervoltage detection time of the main power supply	Setting range	Default	Unit	Available mode			
		70~2000	70	ms	P	S	T	F

This parameter is used to set the undervoltage detection time of the main power supply.

**Note:** The function is invalid if it is set to be 2000.

P4.37	Data	16bit	Data format	DEC
	Modbus communication address	1874,1875	CANopen communication address	0x2425,0x00

	address		address	
--	---------	--	---------	--

	P4.38	Motor overload ratio	Setting range	Default	Unit	Available mode			
			0.0~500.0	115.0	%	P	S	T	F

This parameter is used to set the alarm threshold of the motor overload. If the actual load ratio is more than this setting value, it will report alarm.

P4.38	Data	16bit	Data format	DEC
	Modbus communication address	1876,1877	CANopen communication address	0x2426,0x00

	P4.39	Speed tolerance	Setting range	Default	Unit	Available mode			
			0~20000	0	r/min	P	S		F

This parameter is used to set the test conditions of the speed tolerance. If the absolute value of the minus of actual speed command and motor speed is larger than this value and lasts for more than 100ms, it will report speed tolerance alarm.

**Note:** If it is set to be 0, the speed tolerance will not be tested.

P4.39	Data	16bit	Data format	DEC
	Modbus communication address	1878,1879	CANopen communication address	0x2427,0x00

	P4.40	Forward speed limit	Setting range	Default	Unit	Available mode			
			0~20000	20000	r/min	P	S	T	F

This parameter is used to set the forward speed limit.

**Note:** The default value and setting range of the parameter is relative to the power level.

P4.40	Data	16bit	Data format	DEC
	Modbus communication address	1880,1881	CANopen communication address	0x2428,0x00

	P4.41	Reverse speed limit	Setting	Default	Unit	Available mode			
--	-------	---------------------	---------	---------	------	----------------	--	--	--



			range						
			-20000~0	-20000	r/min	P	S	T	F
This parameter is used to set the reverse speed limit.									
<b>Note:</b> The default value and setting range of the parameter is relative to the power level.									
P4.41	Data	16bit	Data format	DEC					
	Modbus communication address	1882,1883	CANopen communication address	0x2429.0x00					

	P4.50 <sup>1</sup>	Offset of encoder Z phase	Setting range	Default	Unit	Available mode			
			0~1048575	0	pulse	P	S	T	F
This parameter is used to set the output position of Z phase, and the setting value of the offset of Z phase is the pulse of CCW direction.									
P4.50 <sup>1</sup>	Data	32bit	Data format	DEC					
	Modbus communication address	1900,1901	CANopen communication address	0x2432.0x00					

	P4.51	Switching time 1 of the torque limit	Setting range	Default	Unit	Available mode			
			0~4000	0	ms/(100%)	P	S		F
This parameter is used to set the switching time from the first torque limit to the second torque limit.									
P4.51	Data	16bit	Data format	DEC					
	Modbus communication address	1902,1903	CANopen communication address	0x2433.0x00					

	P4.52	Switching time 2 of the torque limit	Setting range	Default	Unit	Available mode			
			0~4000	0	ms/(100%)	P	S		F
This parameter is used to set the switching time from the second torque limit to the first torque limit.									
P4.52	Data	16bit	Data format	DEC					

	Modbus communication address	1904,1905	CANopen communication address	0x2434,0x00
--	------------------------------	-----------	-------------------------------	-------------

P4.53	Current loop response inching	Setting range	Default	Unit	Available mode			
		50.0~100.0	100.0	%	P	S	T	F

This parameter is used to set the current loop response inching factor.

P4.53	Data	16bit	Data format	DEC
	Modbus communication address	1906,1907	CANopen communication address	0x2435,0x00

P4.54 <sup>1</sup>	Initialization time after power on	Setting range	Default	Unit	Available mode			
		0~10000	0	ms	P	S	T	F

This parameter is used to set the initialization time after power on.

P4.54 <sup>1</sup>	Data	16bit	Data format	DEC
	Modbus communication address	1908,1909	CANopen communication address	0x2436,0x00

### 6.5.4 Full-closed loop control

P4.60 <sup>1</sup>	Frequency division molecular of external grating ruler	Setting range	Default	Unit	Available mode			
		0~1048576	0	-				F

This parameter is used to set the frequency division molecular of external grating ruler. When the setting value is 0, the encoder resolution is default as the as frequency division molecular.

P4.60 <sup>1</sup>	Data	32bit	Data format	DEC
	Modbus communication address	1920,1921	CANopen communication address	0x243C,0x00

P4.61 <sup>1</sup>	Frequency division denominator of external grating ruler	Setting range	Default	Unit	Available mode			
		0~1048576	10000	-				F

This parameter is used to set the frequency division denominator of external grating ruler.

P4.61 <sup>1</sup>	Data	32bit	Data format	DEC
	Modbus communication address	1922,1923	CANopen communication address	0x243D,0x00

P4.62 <sup>1</sup>	Direction reverse of external grating ruler	Setting range	Default	Unit	Available mode		
		0~1	0	-			F

This parameter is used to set the direction reverse of external grating ruler.

Setting value	Function
【0】	Use the counting value of the grating ruler directly
1	Use after the reversing of the counting value of the grating ruler

P4.62 <sup>1</sup>	Data	16bit	Data format	DEC
	Modbus communication address	1924,1925	CANopen communication address	0x243E,0x00

P4.64 <sup>1</sup>	Large mixed deviation setting	Setting range	Default	Unit	Available mode		
		1~134217728	160000	Command unit			F

In the full-close loop control, the deviation between the encoder feedback position and the grating ruler feedback position can be set. If R0.05 exceeds the setting value, the drive will report Er22-1.

P4.64 <sup>1</sup>	Data	32bit	Data format	DEC
	Modbus communication address	1928,1929	CANopen communication address	0x2440,0x00

P4.65 <sup>1</sup>	Mixed deviation clearing	Setting range	Default	Unit	Available mode		
		0~100	0	Circle			F

This parameter is used to set the condition of mixed deviation clearing. After rotates for several circles, the mixed control will be cleared. If it is set to be 0, the control will not be cleared.

P4.65 <sup>1</sup>	Data	16bit	Data format	DEC
	Modbus communication address	1930,1931	CANopen communication address	0x2441,0x00

P4.67 <sup>1</sup>	External grating pulse output of AB phase	Setting range	Default	Unit	Available mode			
		0~1	0	-				F

In the full closed loop mode, this parameter is used to set the pulse feedback signal source.

Setting value	Pulse feedback signal source
【0】	Encoder feedback
1	Grating ruler feedback

P4.67 <sup>1</sup>	Data	16bit	Data format	DEC
	Modbus communication address	1934,1935	CANopen communication address	0x2443,0x00

P4.68 <sup>1</sup>	External grating ruler (2 <sup>nd</sup> encoder) resolution	Setting range	Default	Unit	Available mode			
		1~1048576	10000	pulse	P			F

Set the external grating ruler (2<sup>nd</sup> encoder) resolution. When connecting the 2<sup>nd</sup> encoder, output the number of pulses per circle.

P4.68 <sup>1</sup>	Data	32bit	Data format	DEC
	Modbus communication address	1936, 1937	CANopen communication address	0x2444, 0x00

P4.69 <sup>1</sup>	Frequency division output source	Setting range	Default	Unit	Available mode			
		0~3	0	-	P	S	T	F

Set the signal source of frequency division output.

	Setting value	Pulse feedback signal source		
	<b>【0】</b>	Normal frequency division output		
	1	2 <sup>nd</sup> encoder Bypass		
	2	AB quadrature pulse input Bypass		
	3	Internal virtual spindle		
P4.69 <sup>1</sup>	Data	32bit	Data format	DEC
	Modbus communication address	1938, 1939	CANopen communication address	0x2445, 0x00

	P4.78 <sup>1</sup>	MotionNet node number	Setting range	Default	Unit	Available mode				
			0~63	0	-	P	S	T	F	
Set the node number of the local machine (slave station) in MotionNet communication.										
P4.78 <sup>1</sup>	Data	16bit	Data format	DEC						
	Modbus communication address	1956, 1957	CANopen communication address	0x244E, 0x00						

	P4.79 <sup>1</sup>	MotionNet baud rate	Setting range	Default	Unit	Available mode				
			0~3	2	-	P	S	T	F	
Set MotionNet baud rate as follows:										
	Setting value	Baud rate								
	0	2.5Mbps								
	1	5.0Mbps								
	<b>【2】</b>	10.0Mbps								
	3	20.0Mbps								
P4.79 <sup>1</sup>	Data	16bit	Data format	DEC						
	Modbus communication address	1958, 1959	CANopen communication address	0x244F, 0x00						

	P4.80	PZD setting parameter 1 configuration	Setting range	Default	Unit	Available mode			
--	-------	---------------------------------------	---------------	---------	------	----------------	--	--	--

			1000~2398	1998	-	P	S	T	F
This parameter is used to set the mapping content of setting parameter 1 (1998 corresponds to the reserved parameters).									
P4.80	Data	16bit	Data format	DEC					
	Modbus communication address	1960,1961	CANopen communication address	0x2450,0x00					

P4.81	PZD setting parameter 2 configuration	Setting range	Default	Unit	Available mode				
		1000~2398	1998	-	P	S	T	F	
This parameter is used to set the mapping content of setting parameter 2 (1998 corresponds to the reserved parameters).									
P4.81	Data	16bit	Data format	DEC					
	Modbus communication address	1962,1963	CANopen communication address	0x2451,0x00					

P4.82	PZD setting parameter 3 configuration	Setting range	Default	Unit	Available mode				
		1000~2398	1998	-	P	S	T	F	
This parameter is used to set the mapping content of setting parameter 3 (1998 corresponds to the reserved parameters).									
P4.82	Data	16bit	Data format	DEC					
	Modbus communication address	1964,1965	CANopen communication address	0x2452,0x00					

P4.83	PZD feedback parameter 1 configuration	Setting range	Default	Unit	Available mode				
		4000~5852	4012	-	P	S	T	F	
This parameter is used to set the mapping content of feedback parameter 1 (4012 corresponds to R0.04).									
P4.83	Data	16bit	Data format	DEC					
	Modbus	1966,1967	CANopen	0x2453,0x00					

	communication address		communication address	
--	-----------------------	--	-----------------------	--

P4.84	PZD feedback parameter 2 configuration	Setting range	Default	Unit	Available mode			
		4000~5852	4018	-	P	S	T	F

This parameter is used to set the mapping content of feedback parameter 2 (4018 corresponds to R0.07).

P4.84	Data	16bit	Data format	DEC
	Modbus communication address	1968,1969	CANopen communication address	0x2454,0x00

P4.85	PZD feedback parameter 3 configuration	Setting range	Default	Unit	Available mode			
		4000~5852	4032	-	P	S	T	F

This parameter is used to set the mapping content of feedback parameter 3 (4032 corresponds to R0.14).

P4.85	Data	16bit	Data format	DEC
	Modbus communication address	1970,1971	CANopen communication address	0x2455,0x00

P4.86 <sup>1</sup>	PPO type of DP communication	Setting range	Default	Unit	Available mode			
		5	5	-	P	S	T	F

This parameter is used to set the frame type of PROFIBUS-DP communication.

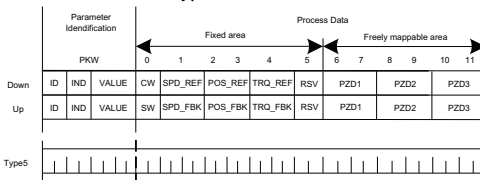

**Note:** SV-DA200 only supports PROFIBUS-DPV0 and the PPO only supports 5.

P4.86 <sup>1</sup>	Data	16bit	Data format	DEC
	Modbus	1972,1973	CANopen	0x2456,0x00

	communication address		communication address	
--	-----------------------	--	-----------------------	--

P4.87	CANopen communication cycle	Setting range	Default	Unit	Available mode			
		0~2 <sup>31</sup> -1	0	us	P	S	T	F

CANopen communication cycle of the slave station.

**Note:** The unit is recommended as 1000us.

P4.87	Data	16bit	Data format	DEC			
	Modbus communication address	1974,1975	CANopen communication address	0x2457,0x00			

P4.88	CANopen heartbeat cycle	Setting range	Default	Unit	Available mode			
		0~32767	1000	ms	P	S	T	F

CANopen heartbeat cycle of the slave station.

P4.88	Data	16bit	Data format	DEC			
	Modbus communication address	1976,1977	CANopen communication address	0x2458,0x00			

### 6.5.5 Special instruction

P4.90*	Fault restore	Setting range	Default	Unit	Available mode			
		0~1	0	-	P	S	T	F

This parameter can be set through the upper PC for the fault clearing.

Setting value	Function
【0】	Disabled
1	Enabled

**Note:** 1. If the command is enabled, and the servo drive is disabled, if the fault can not happen, the fault can be restore automatically. But other fault can not be cleared online.

2. The user can carry out the fault clearing through LED operation.

P4.90*	Data	16bit	Data format	DEC			
--------	------	-------	-------------	-----	--	--	--



	Modbus communication address	1980,1981	CANopen communication address	0x245A,0x00
--	------------------------------	-----------	-------------------------------	-------------

	P4.91*	Parameters saving	Setting range	Default	Unit	Available mode			
			0~1	0	-	P	S	T	F

If P4.10 is 1 or 2, or P0.17 is 1, the saving command can be sent and written into EEPROM.

Setting value	Function
【0】	Disabled
1	Enabled

P4.91*	Data	16bit	Data format	DEC
	Modbus communication address	1982,1983	CANopen communication address	0x245B,0x00

	P4.92*	Restore to the factory value	Setting range	Default	Unit	Available mode			
			0~1	0	-	P	S	T	F

After the operation, all parameters can restore to the factory state except the factory parameters.

Setting value	Function
【0】	Disabled
1	Enabled

P4.92*	Data	16bit	Data format	DEC
	Modbus communication address	1984,1985	CANopen communication address	0x245C,0x00

	P4.93*	Read enabled of the fault record	Setting range	Default	Unit	Available mode			
			0~1	0	-	P	S	T	F

This parameter can set the enabling of reading the fault record.

	Setting value	Function		
	【0】	Disabled		
	1	Enabled		

P4.93*	Data	16bit	Data format	DEC
	Modbus communication address	1986,1987	CANopen communication address	0x245D,0x00

	P4.94*	Clear enabling of fault record	Setting range	Default	Unit	Available mode			
			0~1	0	-	P	S	T	F

This parameter can set the enabling of clearing the fault record.

	Setting value	Function		
	【0】	Disabled		
	1	Enabled		

P4.94*	Data	16bit	Data format	DEC
	Modbus communication address	1988,1989	CANopen communication address	0x245E,0x00

	P4.95*	Group number of fault record	Setting range	Default	Unit	Available mode			
			0~9	0	-	P	S	T	F

This parameter can set the group number of fault record.  
0 corresponds to the group 1 fault recorded and the latest one.

P4.95*	Data	16bit	Data format	DEC
	Modbus communication address	1990,1991	CANopen communication address	0x245F,0x00

	P4.96*	Initial angle encoder test	Setting	Default	Unit	Available mode			
--	--------	----------------------------	---------	---------	------	----------------	--	--	--

			range						
			0~1	0	-	P	S	T	F
<p>This parameter is used to set the initial angle encoder test.</p> <p>If the encoder is the communication encoder (the encoder is type 3,4,5,6), the angle will be written into the EEPROM after test.</p> <p><b>Note:</b>1. The motor shaft can not be connected with any load during test.</p> <p>2. This function is only for the factory.</p>									
P4.96*	Data	16bit	Data format	DEC					
	Modbus communication address	1992,1993	CANopen communication address	0x2460,0x00					

	P4.97*	EEPROM operation	Setting range	Default	Unit	Available mode			
			0~1	0	-	P	S	T	F
<p>All the motor parameters can be written into the EEPROM and during the starting, the drive will initialize the data of the relative parameters.</p>									
P4.97*	Data	16bit	Data format	DEC					
	Modbus communication address	1994,1995	CANopen communication address	0x2461,0x00					









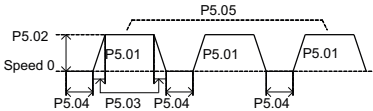

	P4.98*	EEPROM data fault block	Setting range	Default	Unit	Available mode			
			0~1	0	-	P	S	T	F
<p>This parameter can be used to shield the no data and error data fault of encoder EEPROM.</p> <p>If Er2-c or Er2-d occurs, set correct motor model and power on, the motor can be used. And the drive will initialize the motor parameters of relative data in EEPROM.</p>									
P4.98*	Data	16bit	Data format	DEC					
	Modbus communication address	1996,1997	CANopen communication address	0x2462,0x00					

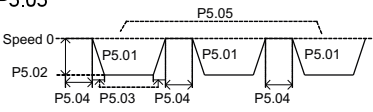

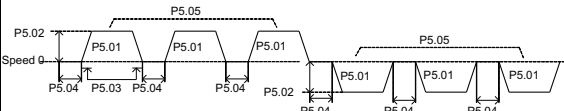
## 6.6 Bit control and returning (P5 and P6)

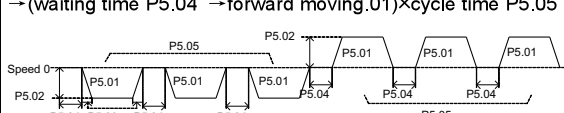
### 6.6.1 Program JOG

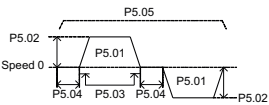
P5.00	JOG mode	Setting range	Default	Unit	Available mode		
		0~6	0	-	P		

This parameter is used to set the JOG operation mode:

Mode	Start key	Function
<b>【0】</b>		(waiting time P5.04 → forward moving P5.01) × cycle time P5.05 
1		(waiting time P5.04 → reverse moving P5.01) × cycle time P5.05 
2		(waiting time P5.04 → forward moving P5.01) × cycle time P5.05 → (waiting time P5.04 → reverse moving P5.01) × cycle time P5.05 
3		(waiting time P5.04 → reverse moving P5.01) × cycle time P5.05 → (waiting time P5.04 → forward moving P5.01) × cycle time P5.05 
4		(waiting time P5.04 → forward moving P5.01 → waiting time P5.04 → reverse moving P5.01) × cycle time P5.05 
5		(waiting time P5.04 → reverse moving P5.01 → waiting time

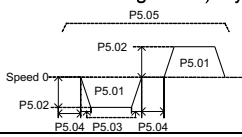
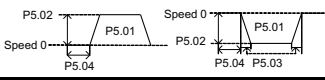
6	 Or 	P5.04 →forward moving P5.01×cycle time P5.05 		
		(waiting time P5.04→forward or reverse moving P5.01)×cycle 1 time 		
P5.00	Data	16bit	Data format	DEC
	Modbus communication address	2000,2001	CANopen communication address	0x2500,0x00

P5.01	JOG movement amount	Setting range	Default	Unit	Available mode		
		1~2 <sup>30</sup>	50000	pulse	P		
This parameter is used to set the JOG movement amount.							
P5.01	Data	32bit	Data format	DEC			
	Modbus communication address	2002,2003	CANopen communication address	0x2501,0x00			

P5.02	JOG speed setting	Setting range	Default	Unit	Available mode		
		1~5000	500	r/min	P		
This parameter is used to set the highest JOG speed.							
P5.02	Data	16bit	Data format	DEC			
	Modbus communication address	2004,2005	CANopen communication address	0x2502,0x00			

P5.03	JOG ACC/DEC time	Setting range	Default	Unit	Available mode		
		2~10000	100	ms	P		

This parameter is used to set the JOG ACC/DEC time and the time corresponds to the time from zero speed to the rated speed. For example, if the target speed is from zero speed to 50% of the rated speed, it is 50% of the time to the target speed.

P5.03	Data	16bit	Data format	DEC
	Modbus communication address	2006,2007	CANopen communication address	0x2503,0x00

P5.04	JOG waiting time	Setting range	Default	Unit	Available mode		
		0~10000	100	ms	P		

This parameter is used to set the JOG waiting time and the time is from JOG starting to the actual operation time or the time from the finishing of one displacement to the starting of next displacement.

P5.04	Data	16bit	Data format	DEC
	Modbus communication address	2008,2009	CANopen communication address	0x2504,0x00

P5.05	JOG cycle times	Setting range	Default	Unit	Available mode		
		0~10000	1	-	P		

This parameter is used to set the JOG cycle times. Please refer to P5.00.

P5.05	Data	16bit	Data format	DEC
	Modbus communication address	2010,2011	CANopen communication address	0x2505,0x00

**6.6.2 Back to the origin**

P5.10 <sup>1</sup>	Returning mode	Setting range	Default	Unit	Available mode		
		0~128	0	-	P		F

This parameter is used to set the returning mode.  
 Display mode: DEC

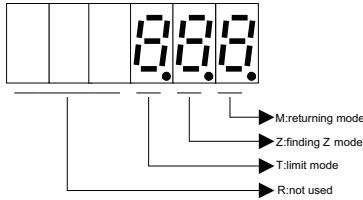

R	T	Z	M
Reserved	Limit mode	Finding Z mode	Returning mode
	0-1	0-2	0-8
	T: Invalid	Z=0: define the point of finding Z as the origin;	M=0: forward rotation, the forward limit switch is the returning point
	T: Invalid	Z=1 define the point of finding Z as the origin;	M=1: reverse rotation, the reverse limit switch is the returning point
	To the limit	Z=2: not finding Z, define the point of returning as the origin	M=2: forward rotation, the rising edge of the origin switch is the returning point
	T=0: report the exceeding fault		M=3: reverse rotation, the rising edge of the origin switch is the returning point
	T=1: direction reverse		
		Z: Invalid	M=4: forward rotation, the first Z single is the returning point
		Z: Invalid	M=5: reverse rotation, the first Z single is the returning point
		define the point of finding Z as the origin;	M=6: forward rotation, the declining edge of the origin switch is the returning point
	Z=1 define the point of finding Z as the origin;	M=7: reverse rotation, the declining edge of the origin switch is the returning point	

			Z=2: not finding Z, define the point of returning as the origin		
		T: Invalid		M=8: the current position is defined as the origin	
P5.10 <sup>1</sup>	Data	16bit	Data format	DEC	
	Modbus communication address	2020,2021	CANopen communication address	0x2505,0x00	

P5.11	To the origin automatically after power on	Setting range	Default	Unit	Available mode								
		0~1	0	-	P								
<p>This parameter is used to set whether it can be to the origin automatically after power on.</p> <table border="1"> <tr> <th>Setting value</th> <th>Instruction</th> </tr> <tr> <td>【0】</td> <td>Invalid</td> </tr> <tr> <td>1</td> <td>Valid</td> </tr> </table>								Setting value	Instruction	【0】	Invalid	1	Valid
Setting value	Instruction												
【0】	Invalid												
1	Valid												
<b>Note:</b> It is valid when no fault occurs.													
P5.11	Data	16bit	Data format	DEC									
	Modbus communication address	2022,2023	CANopen communication address	0x250B,0x00									

P5.12	High speed of the first step	Setting range	Default	Unit	Available mode		
		0~2000	100	r/min	P		



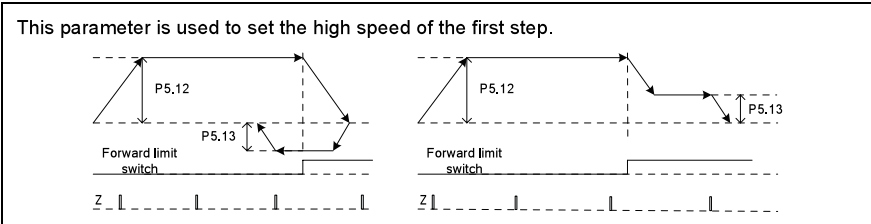

P5.12	Data	16bit	Data format	DEC
	Modbus communication address	2024,2025	CANopen communication address	0x250C,0x00

P5.13	High speed of the second step	Setting range	Default	Unit	Available mode		
		0~500	20	r/min	P		

This parameter is used to set the high speed of the second step.

P5.13	Data	16bit	Data format	DEC
	Modbus communication address	2026,2027	CANopen communication address	0x250D,0x00

P5.14	Origin setting	Setting range	Default	Unit	Available mode		
		$-(2^{31}-1)\sim(2^{31}-1)$	0	pulse	P		

This parameter is used to set the setting value of the origin.

P5.14	Data	32bit	Data format	DEC
	Modbus communication address	2028,2029	CANopen communication address	0x250E,0x00

P5.15*	Trigger command	Setting range	Default	Unit	Available mode		
		0~1	0	-	P		

This parameter is used to trigger the returning command.

P5.15*	Data	16bit	Data format	DEC
	Modbus communication address	2030,2031	CANopen communication address	0x250F,0x00

	address		address	
--	---------	--	---------	--

### 6.6.3 PTP control

	P5.20*	Step trigger command	Setting range	Default	Unit	Available mode				
			-1~100	-1	-	P				

This parameter is used to trigger the target step.

Write: step trigger, the internal buffer can receive at most 8 trigger signal.

Signal	Function
【-1】	Invalid
0-15	Control 0-15 step, the same as the function of SI:CTRG+ POSn
16-99	Invalid, can not be written
100	Be forced to stop

**Example:**

Wiring step signal 3 means to trigger the step program 3.

	Data	16bit	Data format	DEC
P5.20*	Modbus communication address	2040,2041	CANopen communication address	0x2514,0x00

	P5.21	00 target speed	Setting range	Default	Unit	Available mode				
			0~6000	20	r/min	P				
	P5.22	01 target speed	Setting range	Default	Unit	Available mode				
			0~6000	50	r/min	P				
	P5.23	02 target speed	Setting range	Default	Unit	Available mode				
			0~6000	100	r/min	P				
	P5.24	03 target speed	Setting range	Default	Unit	Available mode				
			0~6000	200	r/min	P				
	P5.25	04 target speed	Setting	Default	Unit	Available mode				

			range						
			0~6000	300	r/min	P			
P5.26	05 target speed	Setting range	Default	Unit	Available mode				
			0~6000	500	r/min	P			
P5.27	06 target speed	Setting range	Default	Unit	Available mode				
			0~6000	600	r/min	P			
P5.28	07 target speed	Setting range	Default	Unit	Available mode				
			0~6000	800	r/min	P			
P5.29	08 target speed	Setting range	Default	Unit	Available mode				
			0~6000	1000	r/min	P			
P5.30	09 target speed	Setting range	Default	Unit	Available mode				
			0~6000	1300	r/min	P			
P5.31	10 target speed	Setting range	Default	Unit	Available mode				
			0~6000	1500	r/min	P			
P5.32	11 target speed	Setting range	Default	Unit	Available mode				
			0~6000	1800	r/min	P			
P5.33	12 target speed	Setting range	Default	Unit	Available mode				
		0~6000	2000	r/min	P				
P5.34	13 target speed	Setting range	Default	Unit	Available mode				
		0~6000	2300	r/min	P				
P5.35	14 target speed	Setting range	Default	Unit	Available mode				
		0~6000	2500	r/min	P				
P5.36	15 target speed	Setting range	Default	Unit	Available mode				

			0~6000	3000	r/min	P			
These parameters are used to set the target speed of bit 00 ~15.									
P5.21	Data	16bit	Data format	DEC					
	Modbus communication address	2042,2043	CANopen communication address	0x2515,0x00					
P5.22	Data	16bit	Data format	DEC					
	Modbus communication address	2044,2045	CANopen communication address	0x2516,0x00					
P5.23	Data	16bit	Data format	DEC					
	Modbus communication address	2046,2047	CANopen communication address	0x2517,0x00					
P5.24	Data	16bit	Data format	DEC					
	Modbus communication address	2048,2049	CANopen communication address	0x2518,0x00					
P5.25	Data	16bit	Data format	DEC					
	Modbus communication address	2050,2051	CANopen communication address	0x2519,0x00					
P5.26	Data	16bit	Data format	DEC					
	Modbus communication address	2052,2053	CANopen communication address	0x251A,0x00					
P5.27	Data	16bit	Data format	DEC					
	Modbus communication address	2054,2055	CANopen communication address	0x251B,0x00					
P5.28	Data	16bit	Data format	DEC					
	Modbus communication address	2056,2057	CANopen communication address	0x251C,0x00					
P5.29	Data	16bit	Data format	DEC					

	Modbus communication address	2058,2059	CANopen communication address	0x251D,0x00
P5.30	Data	16bit	Data format	DEC
	Modbus communication address	2060,2061	CANopen communication address	0x251E,0x00
P5.31	Data	16bit	Data format	DEC
	Modbus communication address	2062,2063	CANopen communication address	0x251F,0x00
P5.32	Data	16bit	Data format	DEC
	Modbus communication address	2064,2065	CANopen communication address	0x2520,0x00
P5.33	Data	16bit	Data format	DEC
	Modbus communication address	2066,2067	CANopen communication address	0x2521,0x00
P5.34	Data	16bit	Data format	DEC
	Modbus communication address	2068,2069	CANopen communication address	0x2522,0x00
P5.35	Data	16bit	Data format	DEC
	Modbus communication address	2070,2071	CANopen communication address	0x2523,0x00
P5.36	Data	16bit	Data format	DEC
	Modbus communication address	2072,2073	CANopen communication address	0x2524,0x00

	P5.37	00 ACC/DEC time	Setting range	Default	Unit	Available mode				
			0~32767	200	ms	P				

			Setting range	Default	Unit	Available mode			
P5.38	01 ACC/DEC time		0~32767	300	ms	P			
P5.39	02 ACC/DEC time		0~32767	500	ms	P			
P5.40	03 ACC/DEC time		0~32767	600	ms	P			
P5.41	04 ACC/DEC time		0~32767	800	ms	P			
P5.42	05 ACC/DEC time		0~32767	900	ms	P			
P5.43	06 ACC/DEC time		0~32767	1000	ms	P			
P5.44	07 ACC/DEC time		0~32767	1200	ms	P			
P5.45	08 ACC/DEC time		0~32767	1500	ms	P			
P5.46	09 ACC/DEC time		0~32767	2000	ms	P			
P5.47	10 ACC/DEC time		0~32767	2500	ms	P			
P5.48	11 ACC/DEC time		0~32767	3000	ms	P			
P5.49	12 ACC/DEC time		Setting	Default	Unit	Available mode			

			range						
			0~32767	5000	ms	P			
	P5.50	13 ACC/DEC time	Setting range	Default	Unit	Available mode			
			0~32767	8000	ms	P			
	P5.51	14 ACC/DEC time	Setting range	Default	Unit	Available mode			
			0~32767	50	ms	P			
	P5.52	15 ACC/DEC time	Setting range	Default	Unit	Available mode			
			0~32767	30	ms	P			

These parameters are used to set the ACC/DEC time of bit 00 ~15.

P5.37	Data	16bit	Data format	DEC
	Modbus communication address	2074,2075	CANopen communication address	0x2525,0x00
P5.38	Data	16bit	Data format	DEC
	Modbus communication address	2076,2077	CANopen communication address	0x2526,0x00
P5.39	Data	16bit	Data format	DEC
	Modbus communication address	2078,2079	CANopen communication address	0x2527,0x00
P5.40	Data	16bit	Data format	DEC
	Modbus communication address	2080,2081	CANopen communication address	0x2528,0x00
P5.41	Data	16bit	Data format	DEC
	Modbus communication address	2082,2083	CANopen communication address	0x2529,0x00
P5.42	Data	16bit	Data format	DEC
	Modbus communication	2084,2085	CANopen communication	0x252A,0x00

	address		address	
P5.43	Data	16bit	Data format	DEC
	Modbus communication address	2086,2087	CANopen communication address	0x252B,0x00
P5.44	Data	16bit	Data format	DEC
	Modbus communication address	2088,2089	CANopen communication address	0x252C,0x00
P5.45	Data	16bit	Data format	DEC
	Modbus communication address	2090,2091	CANopen communication address	0x252D,0x00
P5.46	Data	16bit	Data format	DEC
	Modbus communication address	2092,2093	CANopen communication address	0x252E,0x00
P5.47	Data	16bit	Data format	DEC
	Modbus communication address	2094,2095	CANopen communication address	0x252F,0x00
P5.48	Data	16bit	Data format	DEC
	Modbus communication address	2096,2097	CANopen communication address	0x2530,0x00
P5.49	Data	16bit	Data format	DEC
	Modbus communication address	2098,2099	CANopen communication address	0x2531,0x00
P5.50	Data	16bit	Data format	DEC
	Modbus communication address	2100,2101	CANopen communication address	0x2532,0x00
P5.51	Data	16bit	Data format	DEC
	Modbus	2102,2103	CANopen	0x2533,0x00



	communication address		communication address	
P5.52	Data	16bit	Data format	DEC
	Modbus communication address	2104,2105	CANopen communication address	0x2534,0x00

			Setting range	Default	Unit	Available mode				
P5.53	00 delay time		0~32767	0	ms	P				
P5.54	01 delay time		0~32767	100	ms	P				
P5.55	02 delay time		0~32767	200	ms	P				
P5.56	03 delay time		0~32767	400	ms	P				
P5.57	04 delay time		0~32767	500	ms	P				
P5.58	05 delay time		0~32767	800	ms	P				
P5.59	06 delay time		0~32767	1000	ms	P				
P5.60	07 delay time		0~32767	1500	ms	P				
P5.61	08 delay time		0~32767	2000	ms	P				

P5.62	09 delay time	Setting range	Default	Unit	Available mode			
		0~32767	2500	ms	P			
P5.63	10 delay time	Setting range	Default	Unit	Available mode			
		0~32767	3000	ms	P			
P5.64	11 delay time	Setting range	Default	Unit	Available mode			
		0~32767	3500	ms	P			
P5.65	12 delay time	Setting range	Default	Unit	Available mode			
		0~32767	4000	ms	P			
P5.66	13 delay time	Setting range	Default	Unit	Available mode			
		0~32767	4500	ms	P			
P5.67	14 delay time	Setting range	Default	Unit	Available mode			
		0~32767	5000	ms	P			
P5.68	15 delay time	Setting range	Default	Unit	Available mode			
		0~32767	5500	ms	P			

These parameters are used to set the delay time of bit 00 ~15.

P5.53	Data	16bit	Data format	DEC
	Modbus communication address	2106,2107	CANopen communication address	0x2535,0x00
P5.54	Data	16bit	Data format	DEC
	Modbus communication address	2108,2109	CANopen communication address	0x2536,0x00
P5.55	Data	16bit	Data format	DEC
	Modbus communication address	2110,2111	CANopen communication address	0x2537,0x00
P5.56	Data	16bit	Data format	DEC

	Modbus communication address	2112,2113	CANopen communication address	0x2538,0x00
P5.57	Data	16bit	Data format	DEC
	Modbus communication address	2114,2115	CANopen communication address	0x2539,0x00
P5.58	Data	16bit	Data format	DEC
	Modbus communication address	2116,2117	CANopen communication address	0x253A,0x00
P5.59	Data	16bit	Data format	DEC
	Modbus communication address	2118,2119	CANopen communication address	0x253B,0x00
P5.60	Data	16bit	Data format	DEC
	Modbus communication address	2120,2121	CANopen communication address	0x253C,0x00
P5.61	Data	16bit	Data format	DEC
	Modbus communication address	2122,2123	CANopen communication address	0x253D,0x00
P5.62	Data	16bit	Data format	DEC
	Modbus communication address	2124,2125	CANopen communication address	0x253E,0x00
P5.63	Data	16bit	Data format	DEC
	Modbus communication address	2126,2127	CANopen communication address	0x253F,0x00
P5.64	Data	16bit	Data format	DEC
	Modbus communication address	2128,2129	CANopen communication address	0x2540,0x00

P5.65	Data	16bit	Data format	DEC
	Modbus communication address	2130,2131	CANopen communication address	0x2541,0x00
P5.66	Data	16bit	Data format	DEC
	Modbus communication address	2132,2133	CANopen communication address	0x2542,0x00
P5.67	Data	16bit	Data format	DEC
	Modbus communication address	2134,2135	CANopen communication address	0x2543,0x00
P5.68	Data	16bit	Data format	DEC
	Modbus communication address	2136,2137	CANopen communication address	0x2544,0x00

P6.00	00 control word	Setting range	Default	Unit	Available mode		
		0~0x7FFFFFFF	0	-	P		

Description:

Bit	Name	Function
Bit3~0	MODE	Step operation mode
Bit7~4	OPT	Step feature
Bit11~8	JMP	Jump to the next step
Bit15~12	ACC	ACC/DEC time index
Bit19~16	SPD	Target speed index
Bit23~20	DLY	Delay time index
Bit30~24	CYL	Cycle number of the step

MODE:

MODE	Instruction
0	Stop after the excitation of the step
1	Jump to the next step after the excavation
2	Stop after the cycle, the cycle is invalid if CMD=1
3	Jump to the next step after the cycle, the cycle is invalid if

	CMD=1
--	-------

OPT:

Bit	Name	Function
Bit4	INS	Insert off, to stop the executing step or the step to be executed
Bit5	OVLP	Overlap , the step can be overlapped with the next step
Bit7~6	CMD	Position command, 0:incremental position, 1:absolute position

INS:

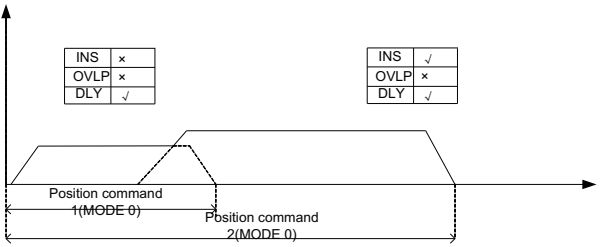
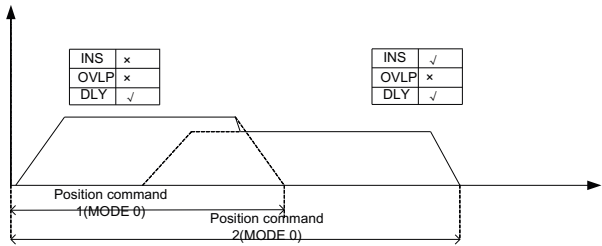

OVLP:

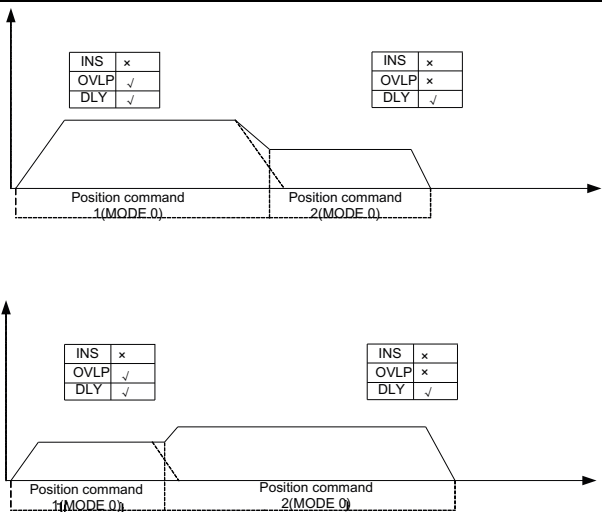

Relationship between INS and OVLP:

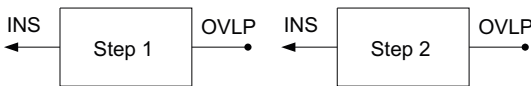

No.	Instruction
1	INS:the step has the priority to the previous step OVLP:the step has the priority to the next step
2	INS has the priority to OVLP; if step 1 OVLP and step 2 INS are enabled at the same time, step 1 OVLP is invalid
3	Two steps which have opposite operation direction can not be overlapped

P6.00	Data	32bit	Data format	HEX
	Modbus communication address	2200,2201	CANopen communication address	0x2600,0x00

P6.01	00 position	Setting range	Default	Unit	Available mode		
		$-(2^{31}-1)\sim(2^{31}-1)$	0	pulse	P		
This parameter is used to set the target position of 01 step. CMD determines the position command mode of the step and P0.37 is invalid.							
P6.01	Data	32bit	Data format	DEC			

	Modbus communication address	2202,2203	CANopen communication address	0x2601,0x00
--	------------------------------	-----------	-------------------------------	-------------

			Setting range	Default	Unit	Available mode			
P6.02	01 control word		0~0x7FFFFFFF	0x00000000	-	P			
P6.04	02 control word		0~0x7FFFFFFF	0x00000000	-	P			
P6.06	03 control word		0~0x7FFFFFFF	0x00000000	-	P			
P6.08	04 control word		0~0x7FFFFFFF	0x00000000	-	P			
P6.10	05 control word		0~0x7FFFFFFF	0x00000000	-	P			
P6.12	06 control word		0~0x7FFFFFFF	0x00000000	-	P			
P6.14	07 control word		0~0x7FFFFFFF	0x00000000	-	P			
P6.16	08 control word		0~0x7FFFFFFF	0x00000000	-	P			
P6.18	09 control word		0~0x7FFFFFFF	0x00000000	-	P			
P6.20	10 control word		0~0x7FFFFFFF	0x00000000	-	P			

P6.22	11 control word	Setting range	Default	Unit	Available mode		
		0~0x7FFFFFFF	0x00000000	-	P		
P6.24	12 control word	Setting range	Default	Unit	Available mode		
		0~0x7FFFFFFF	0x00000000	-	P		
P6.26	13 control word	Setting range	Default	Unit	Available mode		
		0~0x7FFFFFFF	0x00000000	-	P		
P6.28	14 control word	Setting range	Default	Unit	Available mode		
		0~0x7FFFFFFF	0x00000000	-	P		
P6.30	15 control word	Setting range	Default	Unit	Available mode		
		0~0x7FFFFFFF	0x00000000	-	P		

This parameter is used to set the target position of 01~15 step. Please refer to P6.00 for detailed information.

P6.02	Data	32bit	Data format	HEX
	Modbus communication address	2204,2205	CANopen communication address	0x2602,0x00
P6.04	Data	32bit	Data format	HEX
	Modbus communication address	2208,2209	CANopen communication address	0x2604,0x00
P6.06	Data	32bit	Data format	HEX
	Modbus communication address	2212,2213	CANopen communication address	0x2606,0x00
P6.08	Data	32bit	Data format	HEX
	Modbus communication address	2216,2217	CANopen communication address	0x2608,0x00
P6.10	Data	32bit	Data format	HEX
	Modbus	2220,2221	CANopen	0x260A,0x00



	communication address		communication address	
P6.12	Data	32bit	Data format	HEX
	Modbus communication address	2224,2225	CANopen communication address	0x260C,0x00
P6.14	Data	32bit	Data format	HEX
	Modbus communication address	2228,2229	CANopen communication address	0x260E,0x00
P6.16	Data	32bit	Data format	HEX
	Modbus communication address	2232,2233	CANopen communication address	0x2610,0x00
P6.18	Data	32bit	Data format	HEX
	Modbus communication address	2236,2237	CANopen communication address	0x2612,0x00
P6.20	Data	32bit	Data format	HEX
	Modbus communication address	2240,2241	CANopen communication address	0x2614,0x00
P6.22	Data	32bit	Data format	HEX
	Modbus communication address	2244,2245	CANopen communication address	0x2616,0x00
P6.24	Data	32bit	Data format	HEX
	Modbus communication address	2248,2249	CANopen communication address	0x2618,0x00
P6.26	Data	32bit	Data format	HEX
	Modbus communication address	2252,2253	CANopen communication address	0x261A,0x00
P6.28	Data	32bit	Data format	HEX

	Modbus communication address	2256,2257	CANopen communication address	0x261C,0x00
P6.30	Data	32bit	Data format	HEX
	Modbus communication address	2260,2261	CANopen communication address	0x261E,0x00

P6.03	01 position	Setting range	Default	Unit	Available mode			
		$-(2^{31}-1)\sim(2^{31}-1)$	0	pulse	P			
P6.05	02 position	Setting range	Default	Unit	Available mode			
		$-(2^{31}-1)\sim(2^{31}-1)$	0	pulse	P			
P6.07	03 position	Setting range	Default	Unit	Available mode			
		$-(2^{31}-1)\sim(2^{31}-1)$	0	pulse	P			
P6.09	04 position	Setting range	Default	Unit	Available mode			
		$-(2^{31}-1)\sim(2^{31}-1)$	0	pulse	P			
P6.11	05 position	Setting range	Default	Unit	Available mode			
		$-(2^{31}-1)\sim(2^{31}-1)$	0	pulse	P			
P6.13	06 position	Setting range	Default	Unit	Available mode			
		$-(2^{31}-1)\sim(2^{31}-1)$	0	pulse	P			
P6.15	07 position	Setting range	Default	Unit	Available mode			
		$-(2^{31}-1)\sim(2^{31}-1)$	0	pulse	P			
P6.17	08 position	Setting range	Default	Unit	Available mode			
		$-(2^{31}-1)\sim(2^{31}-1)$	0	pulse	P			
P6.19	09 position	Setting range	Default	Unit	Available mode			
		$-(2^{31}-1)\sim(2^{31}-1)$	0	pulse	P			

P6.21	10 position	Setting range	Default	Unit	Available mode			
		$-(2^{31}-1)\sim(2^{31}-1)$	0	pulse	P			
P6.23	11 position	Setting range	Default	Unit	Available mode			
		$-(2^{31}-1)\sim(2^{31}-1)$	0	pulse	P			
P6.25	12 position	Setting range	Default	Unit	Available mode			
		$-(2^{31}-1)\sim(2^{31}-1)$	0	pulse	P			
P6.27	13 position	Setting range	Default	Unit	Available mode			
		$-(2^{31}-1)\sim(2^{31}-1)$	0	pulse	P			
P6.29	14 position	Setting range	Default	Unit	Available mode			
		$-(2^{31}-1)\sim(2^{31}-1)$	0	pulse	P			
P6.31	15 position	Setting range	Default	Unit	Available mode			
		$-(2^{31}-1)\sim(2^{31}-1)$	0	pulse	P			

These parameters are used to set the target position of 01~15 step. CMD determines the position command mode of the step and P0.37 is invalid.

P6.03	Data	32bit	Data format	DEC
	Modbus communication address	2206,2207	CANopen communication address	0x2603,0x00
P6.05	Data	32bit	Data format	DEC
	Modbus communication address	2210,2211	CANopen communication address	0x2605,0x00
P6.07	Data	32bit	Data format	DEC
	Modbus communication address	2214,2015	CANopen communication address	0x2607,0x00
P6.09	Data	32bit	Data format	DEC
	Modbus communication	2218,2219	CANopen communication	0x2609,0x00

	address		address	
P6.11	Data	32bit	Data format	DEC
	Modbus communication address	2222,2223	CANopen communication address	0x260B,0x00
P6.13	Data	32bit	Data format	DEC
	Modbus communication address	2226,2227	CANopen communication address	0x260D,0x00
P6.15	Data	32bit	Data format	DEC
	Modbus communication address	2230,2229	CANopen communication address	0x260F,0x00
P6.17	Data	32bit	Data format	DEC
	Modbus communication address	2234,2235	CANopen communication address	0x2611,0x00
P6.19	Data	32bit	Data format	DEC
	Modbus communication address	2238,2239	CANopen communication address	0x2613,0x00
P6.21	Data	32bit	Data format	DEC
	Modbus communication address	2242,2243	CANopen communication address	0x2615,0x00
P6.23	Data	32bit	Data format	DEC
	Modbus communication address	2246,2247	CANopen communication address	0x2617,0x00
P6.25	Data	32bit	Data format	DEC
	Modbus communication address	2250,2251	CANopen communication address	0x2619,0x00
P6.27	Data	32bit	Data format	DEC
	Modbus	2254,2255	CANopen	0x261B,0x00

	communication address		communication address	
P6.29	Data	32bit	Data format	DEC
	Modbus communication address	2258,2259	CANopen communication address	0x261D,0x00
P6.31	Data	32bit	Data format	DEC
	Modbus communication address	2262,2263	CANopen communication address	0x261F,0x00

## 6.7 Factory parameters (P8,P9 and P10)

## 6.8 State monitoring

### 6.8.1 User monitoring parameters (R0 group)

R0.00	Motor speed	Display range	Precision	Unit
		-20000~20000	0	r/min
Display the actual speed of the motor				
<b>Note:</b> This parameter is processed when displaying.				
R0.00	Data	16bit	Data format	DEC
	Modbus communication address	4000,4001	CANopen communication address	0x3000,0x00

R0.01	Speed command	Display range	Precision	Unit
		-20000~20000	0	r/min
Display the current speed command of the motor.				
<b>Note:</b> If the ACC/DEC time is enabled, the speed command is processed by the ACC/DEC time.				
R0.01	Data	16bit	Data format	DEC
	Modbus communication address	4002,4003	CANopen communication address	0x3001,0x00

R0.02	Feedback pulse accumulation	Display range	Precision	Unit
		$-(2^{63}-1)\sim(2^{63}-1)$	1	pulse

Accumulate and display the feedback accumulation pulse of the servo motor encoder. With sign and the unit is the user unit.

R0.02	Data	64bit	Data format	DEC
	Modbus communication address	4004,4005, 4006,4007	CANopen communication address	0x3002,0x00 0x3002,0x01

R0.03	Command pulse accumulation	Display range	Precision	Unit
		$-(2^{63}-1)\sim(2^{63}-1)$	1	pulse

Accumulate and display the command pulse accumulation. With sign and the unit is the user unit.

R0.03	Data	64bit	Data format	DEC
	Modbus communication address	4008,4009, 4010,4011	CANopen communication address	0x3003,0x00 0x3003,0x01

R0.04	Retention pulse	Display range	Precision	Unit
		$-(2^{31}-1)\sim(2^{31}-1)$	1	pulse

Display the number of retention pulses of the position deviation counter. The 6th bit is the sign bit.

R0.04	Data	32bit	Data format	DEC
	Modbus communication address	4012,4013	CANopen communication address	0x3004,0x00

R0.05	Hybrid control deviation	Display range	Precision	Unit
		$-(2^{31}-1)\sim(2^{31}-1)$	1	pulse

In the mode, this parameter is used to display the deviation between the encoder feedback position and the grating feedback position. With sign, and the unit is the user unit.

R0.05	Data	32bit	Data format	DEC
	Modbus communication address	4014,4015	CANopen communication address	0x3005,0x00

R0.06	Current torque	Display range	Precision	Unit
		-500.0~500.0	0.1	%

Display the current torque. If the rated torque is 100.0%, the actual value will be converted as the percentage value to be displayed.

R0.06	Data	16bit	Data format	DEC
	Modbus communication address	4016,4017	CANopen communication address	0x3006,0x00

R0.07	DC voltage of main circuit	Display range	Precision	Unit
		0.0~1000.0	0.1	V

Display the DC voltage of main circuit.

R0.07	Data	16bit	Data format	DEC
	Modbus communication address	4018,4019	CANopen communication address	0x3007,0x00

R0.08	DC voltage of control circuit	Display range	Precision	Unit
		0.0~1000.0	0.1	V

Display the DC voltage of control circuit.

R0.08	Data	16bit	Data format	DEC
	Modbus communication address	4020,4021	CANopen communication address	0x3008,0x00

R0.09	Output voltage	Display range	Precision	Unit
		0.0~1000.0	0.1	Vrms

Display the valid value of the current output voltage.

R0.09	Data	16bit	Data format	DEC
	Modbus communication address	4022,4023	CANopen communication address	0x3009,0x00

R0.10	Output current	Display range	Precision	Unit
		0.00~1000.00	0.01	Arms

Display the valid value of the output current.

R0.10	Data	16bit	Data format	DEC
	Modbus communication address	4024,4025	CANopen communication address	0x300A,0x00

R0.11	Drive temperature	Display range	Precision	Unit
		-55.0~180.0	0.1	℃

Display the current temperature of the IGBT module.

R0.11	Data	16bit	Data format	DEC
	Modbus communication address	4026,4027	CANopen communication address	0x300B,0x00

R0.12	Torque limit	Display range	Precision	Unit
		-500.0~500.0	0.1	%

Display the current torque limit. If the rated torque is 100.0%, the actual value will be converted as the percentage value to be displayed.

R0.12	Data	16bit	Data format	DEC
	Modbus communication address	4028,4029	CANopen communication address	0x300C,0x00

R0.13	Encoder feedback	Display range	Precision	Unit
		0~1048575	1	pulse

Display the current encoder feedback value.

R0.13	Data	32bit	Data format	DEC
	Modbus communication address	4030,4031	CANopen communication address	0x300D,0x00

R0.14	Position relative to Z pulse	Display range	Precision	Unit
		0~1048575	1	pulse

Display the position of the rotor relative to Z pulse in one revolution. The unit is pulse.

R0.14	Data	32bit	Data format	DEC
-------	------	-------	-------------	-----



	Modbus communication address	4032,4033	CANopen communication address	0x300E,0x00
--	------------------------------	-----------	-------------------------------	-------------

	R0.15	Inertia ratio of load	Display range	Precision	Unit
			0~10000	1	%

Display the predicted value of the ratio of rotational inertia of the servo motor to that of the load converted onto the servo motor's shaft in real-time.

	R0.15	Data	16bit	Data format	DEC
		Modbus communication address	4034,4035	CANopen communication address	0x300F,0x00

	R0.16	Output power	Display range	Precision	Unit
			-500.0~500.0	0.1	%

Display the current output power. If the rated power is 100.0%, the actual value will be converted as the percentage value to be displayed.

**Note:** The negative value means the motor is in power generation.

	R0.16	Data	16bit	Data format	DEC
		Modbus communication address	4036,4037	CANopen communication address	0x3010,0x00

	R0.17	Motor load ratio	Display range	Precision	Unit
			0.0~500.0	0.1	%

Display the actual motor load ratio. If the rated power is 100.0%, the actual value will be converted as the percentage value to be displayed.

	R0.18	Data	16bit	Data format	DEC
		Modbus communication address	4038,4039	CANopen communication address	0x3011,0x00

	R0.18	Molecule of actual electric gear ratio	Display range	Precision	Unit
			0~(2 <sup>31</sup> -1)	1	-

Display the molecule of actual electric gear ratio				
	Data	32bit	Data format	DEC
<b>R0.18</b>	Modbus communication address	4040,4041	CANopen communication address	0x3012,0x00

	<b>R0.19</b>	Denominator of actual electric gear ratio	Display range	Precision	Unit
			1~(2 <sup>31</sup> -1)	1	-

Display the denominator of actual electric gear ratio				
	Data	32bit	Data format	DEC
<b>R0.19</b>	Modbus communication address	4042,4043	CANopen communication address	0x3013,0x00

	<b>R0.20</b>	Position command speed	Display range	Precision	Unit
			-20000~20000	0	r/min

Display the position command speed.				
	Data	16bit	Data format	DEC
<b>R0.20</b>	Modbus communication address	4044,4045	CANopen communication address	0x3014,0x00

	<b>R0.21</b>	Instant speed	Display range	Precision	Unit
			-20000~20000	0	r/min

Display the instant speed of the motor and the speed is not processed by filtering.				
	Data	16bit	Data format	DEC
<b>R0.21</b>	Modbus communication address	4046,4047	CANopen communication address	0x3015,0x00

	<b>R0.22</b>	Bit state	Display range	Precision	Unit
			-1~215	0	-

Display the bit state; -1: no bit control; 0-15: executing bit number; the step and 200 means the step is finished.

R0.22	Data	16bit	Data format	DEC
	Modbus communication address	4048,4049	CANopen communication address	0x3016,0x00

R0.23	Absolute position of encoder feedback	Display range	Precision	Unit
		$-(2^{31}-1)\sim(2^{31}-1)$	0	pulse

Display the absolute position of encoder feedback, and after clearing, the value is 0.

R0.23	Data	32bit	Data format	DEC
	Modbus communication address	4050,4051	CANopen communication address	0x3017,0x00

R0.24	EEPROM data state	Display range	Precision	Unit
		0~3	0	-

Display the EEPROM state when EEPROM has no motor data or the data is not normal , the system will use the internal motor parameters.

Setting value	State
【0】	No EEPROM
1	EEPROM no data
2	EEPROM data error
3	EEPROM data normal

R0.24	Data	16bit	Data format	DEC
	Modbus communication address	4052,4053	CANopen communication address	0x3018,0x00

R0.25	Circles of multi-circle encoder	Display range	Precision	Unit
		-32768~32767	0	-

Display the circles of multi-circle encoder.

R0.25	Data	16bit	Data format	DEC
	Modbus communication	4054, 4055	CANopen communication	0x3019, 0x00

	address		address	
--	---------	--	---------	--

<b>R0.26</b>	Available encoder type	Display range	Precision	Unit
		0~6	0	-

Display the available encoder type.

Setting value	Meaning
<b>【0】</b>	Optical encoder
1	17-bit absolute value encoder
2	20-bit absolute value encoder
3	17-bit absolute value encoder and optical encoder
4	20-bit absolute value encoder and optical encoder
5	12-bit rotary transformer encoder
6	16-bit rotary transformer encoder

<b>R0.26</b>	Data	16bit	Data format	DEC
	Modbus communication address	4056, 4057	CANopen communication address	0x301A, 0x00

<b>R0.27</b>	EtherCAT clock synchronous correction state	Display range	Precision	Unit
		0~1	0	-

When EtherCAT communication synchronous mode selects DC mode, the internal clock of the drive and DC Sync0 are synchronous or not.

Setting value	Meaning
<b>【0】</b>	Unsynchronized
1	Synchronized

<b>R0.27</b>	Data	16bit	Data format	DEC
	Modbus communication address	4058, 4059	CANopen communication address	0x301B, 0x00

	R0.28	State of CANopen state machine	Display range	Precision	Unit																								
			0~18	0	-																								
The current state of CANopen state machine in CAN communication and the state of CoE(CANopen over EtherCAT) state machine in EtherCAT communication																													
<table border="1"> <thead> <tr> <th>Setting value</th> <th>Communication mode</th> <th>Meaning</th> </tr> </thead> <tbody> <tr> <td>【0】</td> <td>-</td> <td>Invalid</td> </tr> <tr> <td>1</td> <td rowspan="4">CAN</td> <td>Init</td> </tr> <tr> <td>2</td> <td>Pre-Op</td> </tr> <tr> <td>5</td> <td>Stop</td> </tr> <tr> <td>8</td> <td>Op(Operational)</td> </tr> <tr> <td>11</td> <td rowspan="4">EtherCAT</td> <td>Init</td> </tr> <tr> <td>12</td> <td>Pre-Op</td> </tr> <tr> <td>14</td> <td>Safe-Op</td> </tr> <tr> <td>18</td> <td>Op(Operational)</td> </tr> </tbody> </table>						Setting value	Communication mode	Meaning	【0】	-	Invalid	1	CAN	Init	2	Pre-Op	5	Stop	8	Op(Operational)	11	EtherCAT	Init	12	Pre-Op	14	Safe-Op	18	Op(Operational)
Setting value	Communication mode	Meaning																											
【0】	-	Invalid																											
1	CAN	Init																											
2		Pre-Op																											
5		Stop																											
8		Op(Operational)																											
11	EtherCAT	Init																											
12		Pre-Op																											
14		Safe-Op																											
18		Op(Operational)																											
R0.28	Data	16bit	Data format	DEC																									
	Modbus communication address	4060, 4061	CANopen communication address	0x301C, 0x00																									

	R0.29	Node of PROFIBUS-DP slave station	Display range	Precision	Unit
			0~99	0	-
Display the received node of PROFIBUS-DP slave station and correspond to the position of rotary switch.					
R0.29	Data	16bit	Data format	DEC	
	Modbus communication address	4062,4063	CANopen communication address	0x301D,0x00	

	R0.30	System state	Display range	Precision	Unit
			0~5	1	-
Display the system state.					

	Setting value	State		
	<b>【0】</b>	initialization		
	1	The high voltage		
	2	ready		
	3	Operation		
	4	Force to stop		
	5	Fault		
<b>R0.30</b>	Data	16bit	Data format	DEC
	Modbus communication address	4064,4065	CANopen communication address	0x301E,0x00

<b>R0.31</b>	IGBT state	Display range	Precision	Unit
		0~1	1	-

Display the IGBT state.

Setting value	State
<b>【0】</b>	Off
1	On

<b>R0.31</b>	Data	16bit	Data format	DEC
	Modbus communication address	4066,4067	CANopen communication address	0x301F,0x00

<b>R0.32</b>	Current mode	Display range	Precision	Unit
		0~7	1	-

Display the current control mode.

Setting value	State
<b>【0】</b>	Position mode
1	Speed mode
2	Torque mode
7	Factory mode

R0.32	Data	16bit	Data format	DEC
	Modbus communication address	4068,4069	CANopen communication address	0x3020,0x00

R0.33	Power on time	Display range	Precision	Unit
		0~(2 <sup>31</sup> -1)	1	s

Display the power on time.

R0.33	Data	32bit	Data format	DEC
	Modbus communication address	4070,4071	CANopen communication address	0x3021,0x00

R0.34	Operation time	Display range	Precision	Unit
		0~(2 <sup>31</sup> -1)	1	s

Display the operation time.

R0.34	Data	32bit	Data format	DEC
	Modbus communication address	4072,4073	CANopen communication address	0x3022,0x00

R0.35	DSP software version	Display range	Precision	Unit
		0.00~10.00	0.01	-

Display the DSP software version.

R0.35	Data	16bit	Data format	DEC
	Modbus communication address	4074,4075	CANopen communication address	0x3023,0x00

R0.36	FPGA software version	Display range	Precision	Unit
		0.00~10.00	0.01	-

Display the FPGA software version.

R0.36	Data	16bit	Data format	DEC
	Modbus communication address	4076,4077	CANopen communication address	0x3024,0x00

	communication address		communication address	
--	-----------------------	--	-----------------------	--

	R0.37	Communication card software version	Display range	Precision	Unit
			0.00~10.00	0.01	-
Display the communication card software version.					
R0.37	Data	16bit	Data format	DEC	
	Modbus communication address	4078,4079	CANopen communication address	0x3025,0x00	

	R0.38	Drive serial No.1	Display range	Precision	Unit
			0~65535	1	-
Display the drive serial No.1					
R0.38	Data	16bit	Data format	DEC	
	Modbus communication address	4080,4081	CANopen communication address	0x3026,0x00	

	R0.39	Drive serial No.2	Display range	Precision	Unit
			0~65535	1	-
Display the drive serial No.2					
R0.39	Data	16bit	Data format	DEC	
	Modbus communication address	4082,4083	CANopen communication address	0x3027,0x00	

	R0.40	Drive serial No.3	Display range	Precision	Unit
			0~65535	1	-
Display the drive serial No.3					
R0.40	Data	16bit	Data format	DEC	
	Modbus communication address	4084,4085	CANopen communication address	0x3028,0x00	



	R0.41	Drive serial No.4	Display range	Precision	Unit
			0~65535	1	-
Display the drive serial No.4					
R0.41	Data	16bit	Data format	DEC	
	Modbus communication address	4086,4087	CANopen communication address	0x3029,0x00	

	R0.42	Drive serial No.5	Display range	Precision	Unit
			0~65535	1	-
Display the drive serial No.5					
R0.42	Data	16bit	Data format	DEC	
	Modbus communication address	4088,4089	CANopen communication address	0x302A,0x00	

	R0.43	Drive serial No.6	Display range	Precision	Unit
			0~65535	1	-
Display the drive serial No.6					
R0.43	Data	16bit	Data format	DEC	
	Modbus communication address	4090,4091	CANopen communication address	0x302B,0x00	

	R0.44	Absolute position of grating ruler (2 <sup>nd</sup> encoder) in single circle	Display range	Precision	Unit
			0~1048575	0	pulse
Display the feedback value of absolute position of grating ruler (2 <sup>nd</sup> encoder) in single circle.					
R0.44	Data	32bit	Data format	DEC	
	Modbus communication address	4092, 4093	CANopen communication address	0x302C, 0x00	

### 6.8.2 IO monitoring parameters (R1)

<b>R1.00</b>	Digital input state	Display range	Precision	Unit
		0x000~0x3FF	-	-
<b>R1.01</b>	Digital output state	Display range	Precision	Unit
		0x00~0x3F	-	-

Detailed instruction:

This value is a hexadecimal number arranged in the sequence of the digital quantities to indicate the state of all digital quantities. When a terminal is in ON state, its corresponding bit is denoted as 1. When a terminal is in OFF state, its corresponding bit is denoted as 0. Then, this binary number is converted into a hexadecimal number. For example, 000000001011 is denoted as 0x00B.

The digital input state is denoted with 3 digits of hexadecimal number. The arrangement sequence of the digital input is: (the digits not listed are filled with 0).

<b>BIT9</b>	<b>BIT8</b>	<b>BIT7</b>	<b>BIT6</b>	<b>BIT5</b>	<b>BIT4</b>	<b>BIT3</b>	<b>BIT2</b>	<b>BIT1</b>	<b>BIT0</b>
SI10	SI9	SI8	SI7	SI6	SI5	SI4	SI3	SI2	SI1

The digital output state is denoted with 2 digits of hexadecimal number. The arrangement sequence of the digital output is:

<b>BIT5</b>	<b>BIT4</b>	<b>BIT3</b>	<b>BIT2</b>	<b>BIT1</b>	<b>BIT0</b>
SO6	SO5	SO4	SO3	SO2	SO1

<b>R1.00</b>	Data	16bit	Data format	HEX
	Modbus communication address	4200,4201	CANopen communication address	0x3100,0x00
<b>R1.01</b>	Data	16bit	Data format	HEX
	Modbus communication address	4202,4203	CANopen communication address	0x3101,0x00

<b>R1.02</b>	Original sample of the analog speed command	Display range	Precision	Unit
		0~65535	1	-

Display the original value of the analog speed command (input channel 1) after AD sample convertering. The default value 32768 corresponds to 0V.

<b>R1.02</b>	Data	16bit	Data format	DEC
	Modbus communication address	4204,4205	CANopen communication address	0x3102,0x00

	R1.03	Original sample of the analog torque command	Display range	Precision	Unit
			0~65535	16	-
Display the original value of the analog torque command (input channel 2) after AD sample converting. The default value 32768 corresponds to 0V.					
R1.03	Data	16bit	Data format	DEC	
	Modbus communication address	4206,4207	CANopen communication address	0x3103,0x00	

	R1.04	Original sample of analog input 3	Display range	Precision	Unit
			0~65535	16	-
Display the original value of the analog input (input channel 3) after AD sample converting. The default value 32768 corresponds to 0V.					
R1.04	Data	16bit	Data format	DEC	
	Modbus communication address	4208,4209	CANopen communication address	0x3104,0x00	

	R1.05	Voltage of the analog speed command	Display range	Precision	Unit
			-10.000~10.000	0.001	V
Display the voltage after correction of the analog speed command (input channel 1).					
R1.05	Data	16bit	Data format	DEC	
	Modbus communication address	4210,4211	CANopen communication address	0x3105,0x00	

	R1.06	Voltage of the analog torque command	Display range	Precision	Unit
			-10.000~10.000	0.005	V
Display the voltage after correction of the torque speed command (input channel 2).					
R1.06	Data	16bit	Data format	DEC	
	Modbus communication address	4212,4213	CANopen communication address	0x3106,0x00	

	R1.07	Voltage of analog input 3	Display range	Precision	Unit
			-10.000~10.000	0.005	V
Display the voltage after correction of analog input channel 3.					
R1.07	Data	16bit	Data format	DEC	
	Modbus communication address	4214,4215	CANopen communication address	0x3107,0x00	

	R1.08	Voltage of analog output 1	Display range	Precision	Unit
			-10.000~10.000	0.001	V
Display the voltage after correction of analog output channel 1.					
R1.08	Data	16bit	Data format	DEC	
	Modbus communication address	4216,4217	CANopen communication address	0x3108,0x00	

	R1.09	Voltage of analog output 2	Display range	Precision	Unit
			-10.000~10.000	0.001	V
Display the voltage after correction of analog output channel 2.					
R1.09	Data	16bit	Data format	DEC	
	Modbus communication address	4218,4219	CANopen communication address	0x3109,0x00	

	R1.11	Cumulative value of input pulses	Display range	Precision	Unit
			$-(2^{31}-1)\sim(2^{31}-1)$	1	pulse
Accumulate and display the received pulse number of external pulse input.					
R1.11	Data	32bit	Data format	DEC	
	Modbus communication address	4222,4223	CANopen communication address	0x310B,0x00	

	R1.12	Pulse position command	Display range	Precision	Unit
--	-------	------------------------	---------------	-----------	------

			$-(2^{31}-1)\sim(2^{31}-1)$	1	pulse
Display the position command in the test cycle of each pulse input command.					
R1.12	Data	32bit	Data format	DEC	
	Modbus communication address	4224,4225	CANopen communication address	0x310C,0x00	

### 6.8.3 Factory monitoring parameters (R2)

#### 6.8.4 Fault records (R3)

R3.00	Fault code record	Display range	Precision	Unit
		-	-	-
Display the fault code when the fault occurs. The default is the latest 1 fault record.				

R3.01	Power on time when fault occurs	Display range	Precision	Unit
		0~(2 <sup>31</sup> -1)	1	s
Display the power on time when the fault occurs.				

R3.02	Operation time when fault occurs	Display range	Precision	Unit
		0~(2 <sup>31</sup> -1)	1	s
Display the operation time when fault occurs.				

R3.03	Motor speed when fault occurs	Display range	Precision	Unit
		-20000~20000	1	r/min
Display the motor speed when fault occurs.				

R3.04	Speed command when fault occurs	Display range	Precision	Unit
		-20000~20000	1	r/min
Display the speed command when fault occurs.				

R3.05	Feedback pulse accumulation when fault occurs	Display range	Precision	Unit
		$-(2^{63}-1)\sim(2^{63}-1)$	1	pulse
Display the feedback pulse accumulation when fault occurs.				

		Command pulse accumulation when fault occurs	Display range	Precision	Unit
	R3.06		$-(2^{63}-1)\sim(2^{63}-1)$	1	pulse
Display the command pulse accumulation when fault occurs.					

		Stranded pulse when fault occurs	Display range	Precision	Unit
	R3.07		$-(2^{31}-1)\sim(2^{31}-1)$	1	pulse
Display the stranded pulse when fault occurs.					

		Current torque when fault occurs	Display range	Precision	Unit
	R3.08		-500.0~500.0	0.1	%
Display the current torque when fault occurs.					

		Main circuit dc voltage when fault occurs	Display range	Precision	Unit
	R3.09		0.0~1000.0	0.1	V
Display the main circuit dc voltage when fault occurs.					

		Output voltage at fault	Display range	Precision	Unit
	R3.10		0.0~1000.0	0.1	Vrms
Display the valid value of the output voltage when the fault occurs.					

		Output current at fault	Display range	Precision	Unit
	R3.11		0.0~1000.0	0.1	Arms
Display the valid value of the output current when the fault occurs.					

		Latest fault record	Display range	Precision	Unit
	R3.20		-	-	-
Displays the fault record of the previous fault occur.					

		Latest 2 fault record	Display range	Precision	Unit
	R3.21		-	-	-
Display the fault record of the latest 2 fault occur.					

	R3.22	Latest 3 fault record	Display range	Precision	Unit
			-	-	-
Display the fault record of the latest 3 fault occur.					

	R3.23	Latest 4 fault record	Display range	Precision	Unit
			-	-	-
Display the fault record of the latest 4 fault occur.					

	R3.24	Latest 5 fault record	Display range	Precision	Unit
			-	-	-
Display the fault record of the latest 5 fault occur.					

	R3.25	Latest 6 fault record	Display range	Precision	Unit
			-	-	-
Display the fault record of the latest 6 fault occur.					

	R3.26	Latest 7 fault record	Display range	Precision	Unit
			-	-	-
Display the fault record of the latest 7 fault occur.					

	R3.27	Latest 8 fault record	Display range	Precision	Unit
			-	-	-
Display the fault record of the latest 8 fault occur.					

	R3.28	Latest 9 fault record	Display range	Precision	Unit
			-	-	-
Display the fault record of the latest 9 fault occur.					

	R3.29	Latest 10 fault record	Display range	Precision	Unit
			-	-	-
Display the fault record of the latest 10 fault occur.					

# Commissioning

# 7

## 7.1 Operation instruction of inertia identification

There are two kinds of online mode and offline mode.

1 Online inertia identification:

It is necessary to set following parameters when online inertia identification is selected: 1.P1.00; 2.P1.08. If P1.00 and P1.08 is more than 0, the online mode is valid. If the inertia identification requirements are met, (1. the speed is more than 150 r/min; 2. the ACC time is longer than 20 ms; 3.the range is more than 150 r/min; 4. in 0.3 seconds, the speed can from 0 r/min to 3000 r/min), the identification result will be updated to P1.01 and written into EEPROM in every 30 minutes.

2 Offline inertia identification:

It is necessary to set following parameters when offline inertia identification is selected: 1.P1.05; 2.P1.06. The offline mode is available by the auxiliary function EF-Jld of the panel operation. Refer to section 5.2.5.5 for the procedure. The offline mode is not affected by P1.00 and P1.08.

Before executing the function of EF-Jld, set P1.05 to the operation mode of the motor, set P1.06 to the rotating cycle and set P1.07 to the mechanical rigidity. The higher the mechanical rigidity, the smaller the ACC/DEC time constant. Set P1.05 to be 1 or 2. The smaller value of P1.06 and P1.07 is, the more correct the identification result is.

When executing the function of EF-Jld, please ensure P1.05 and P1.06 meet the needs; otherwise, there may be damage to the machine. Press Mode key can stop the execution.

If the execution is finished normally, the identification result will be saved into P1.01 automatically. If there is fault, P1.01 will keep the result before identification. If it report Er25-7, increase P1.06 or reduce P1.07.

The precision of the identification result will be affected if following occur: 1. Mechanical rigidity is low; 2. The load inertia change too fast; 3. There is a space; 4. The external disturbance changes too fast.

## 7.2 General method for parameters adjusting

There are two kinds of parameters adjustment:

1. Automatic adjustment setting of rigid choice. The inertia ratio of the load can be counted manually.

There are 32 steps of rigidity for the gain setting of the loop.

◆ The adjustment needs to be carried out to the actual situation:

Mechanical structure	Rigid set
Big handling, transmission equipment	0~13
Belt drive mechanism	5~16
Manipulator	10~20



Mechanical structure	Rigid set
Ball screw + Belt drive	13~25
Direct ball screw or rigid bodies	18~31

The bigger the value is the faster response and higher rigidity and easier vibration. In stable system, higher rigidity setting makes fast response.

2. Manual adjustment. If the servo system has vibration or the control performance is not good, the system performance or the vibration can be improved by adjusting the parameters of speed loop and position loop.

Gain of the speed loop: mainly used to determine the response speed of the speed loop. Under the precondition the mechanical system does not vibrate, the larger the setting of this parameter, the higher the response speed.

Speed loop integration time constant: the speed loop has an integrator which can reflect minor input. This integrator can delay the operation of the servo system. Therefore, when the time constant increases, the response becomes slower, and the required positioning setting time is longer. When the load inertia is larger or the mechanical system is likely to vibrate, the loop integration time parameter must be large enough to avoid the vibration of the mechanical system.

Torque command filter: in some cases the mechanical system may resonate, generating vibration noise of sharp tone. At this time trap wave filtering must be performed to eliminate resonance.

Gain of the position loop: the reaction of the servo system is determined by the gain of the position loop. When the gain of the position loop is set higher, the reaction speed will increase and the time required for positioning will be shortened. If you want to set the gain of the position loop to a high value, the rigidity and natural frequency of the mechanical system must be very high.

In general case the gain of the speed loop should be ensured higher than the gain of the position loop whenever possible. When the position gain is much higher than the speed gain, the system may overshoot under the action of the step signal. This will seriously damage the system performance. Various parameters of the system always limit each other. If only the gain of the position loop increases, the command outputted by the position loop may become unstable. This may cause the reaction of the entire servo system to become unstable. In general cases, we can adjust the system by referring to the follow procedures:

- 1) First set the gain of the position loop at a lower value, then, under the precondition that abnormal sound and vibration are not generated, gradually increase the gain of the speed loop to the maximum.
- 2) Gradually decrease the gain of the speed loop while increasing the gain of the position loop. Under the precondition that the whole response is free from overshoot and vibration, set the gain of the position loop to the maximum.
- 3) Speed loop integration time constant depends on the length of the positioning time. Please

decrease this value as small as possible under the precondition that the mechanical system does not vibrate.

4) After that, finely adjust the gain of the position loop, speed loop and the integration time constant to find their optimal values.

Hereunder we illustrate several typical cases (in each case, only one parameter is changed relative to a case when the parameters are appropriate):

◆ Parameters are appropriate

In this case the parameters are set relatively appropriate. The motor speed can closely follow the position command, the speed has basically no overshoot, and the positioning time is relatively short.

◆ Speed loop integration time constant is relatively small

The speed loop of the servo drive must have high reaction speed. When the speed fluctuates, it indicates that the stability of the speed loop is damaged due to the shorting integration time of the speed loop. This causes the servo motor to run unstably at fluctuating speed.

◆ Speed loop integration time constant is relatively large

In this case, there is no apparent difference with the case when the parameters are appropriate. The influence of the speed loop integration on the speed follow-up position command is not very high, but too large speed loop integration time will delay the reaction time of the speed loop.

◆ Gain of the speed loop is relatively high

In this case, the motor speed will fluctuate. The influence is the same as the case when the speed loop integration time is too short. Both of them must keep coordinated. While increasing the gain of the speed loop, the speed loop integration time must also be increased. Otherwise the servo system will oscillate.

◆ Gain of the speed loop is too low

Decreasing the gain of the speed loop will cause fluctuation of the motor speed to fluctuate. By comparing with the case when the speed gain is too high we can know that the fluctuation frequency of the motor speed is lower in this case which fully indicates that increasing the gain of the speed loop can heighten the operating frequency of the system, improve the quick response performance of the system, and effectively overcome the influence of the interference.

◆ Gain of the position loop is excessively low

In the servo system, the operating frequency of the position loop is much lower than the speed loop. When the gain of the position loop is too low, the system is difficult to eliminate the position deviation formed during speed response. This can cause prolongation of the time interval of the motor speed follow-up position command.

◆ Gain of the position loop is excessively high

In the position servo system, the gain of the position loop also affects the stability. At this time, as the

gain of the position loop is excessively high, it makes the motor speed to fluctuate. Additionally, comparing with the case when the gain of the position loop is too low we can know that the pure time delay of the response to the position command of the motor speed is decreased.

◆ Gain of the position loop is too low

When we adjust the gain of the position loop to a low value, the motor speed follow-up position command represents obvious lag and the positioning time is prolonged largely. The high accuracy and high response performance of the positioning system are seriously affected.

### 7.2.1 Adjustment of the gain of the position loop

The position control block diagram of the SV-DA200 series servo drive is shown in the figure below. The gain parameters that can be adjusted in the position mode are marked on the block diagram.

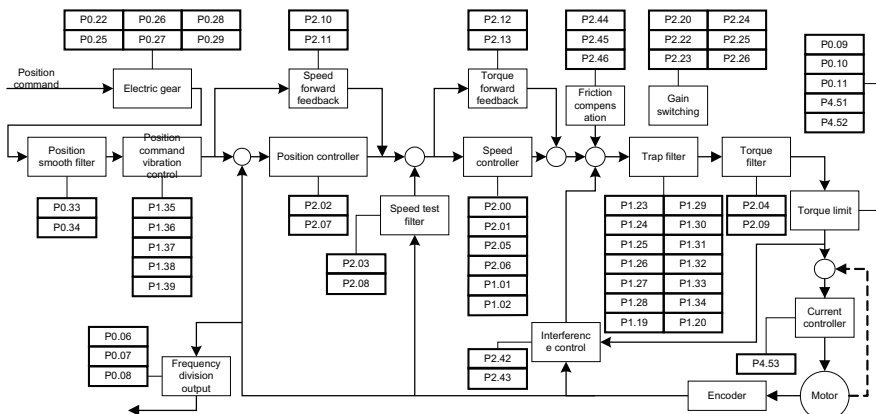

Fig. 7-1 Block diagram of position control

The general procedures for parameter adjustment in the position mode are:

1) Initial setting of the parameters

The defaults of the parameters can be recovered by the default parameter recovering operation (see chapter 5.2.4 for details).

2) Adjustment of the gain of the position loop

When the servo motor is running with default parameters, if the system oscillation occurs with buzz, the position gain(P2.02, P2.07) should be adjusted smaller. If the system rigidity is relatively small, the position gain should be adjusted larger.

3) Adjustment of the position smoothing filter

During position control, if the position pulse commands input frequency varies largely, it may be caused by a larger impulse. At this time the position smoothing filters time constant(P0.33) should be adjusted to moderate the impulse.

4) Adjustment of the electronic gear

If the pulse transmission frequency of the pulse generator is restricted, or the transmission frequency does not meet the mechanical requirements, we can change the pulse input frequency by adjusting the value of the electronic gear parameters(P0.25, P0.26, P0.27, P0.28, P0.29) to meet the requirements for position control.

5) Adjustment of position feed-forward

In the case the retention pulse is large or fault-free follow-up is required, we can improve the position follow-up performance by adjusting the speed feed-forward gain parameter(P2. 10) and speed feed-forward gain filter parameter(P2. 11).However, it should be noted that if the speed feed-forward gain is too large, it may cause system oscillation.

6) Frequency division of the feedback pulse output

If the feedback pulse needs to be outputted, the frequency division coefficient of pulse output(P0.06, P0.07) can be used to change the frequency of the output pulse.

**7.2.2 Adjustment of the gain of the speed loop**

The speed control block diagram of the SV-DA200 series servo drive is shown in the figure below.

The gain parameters that can be adjusted in the speed mode are marked on the block diagram.

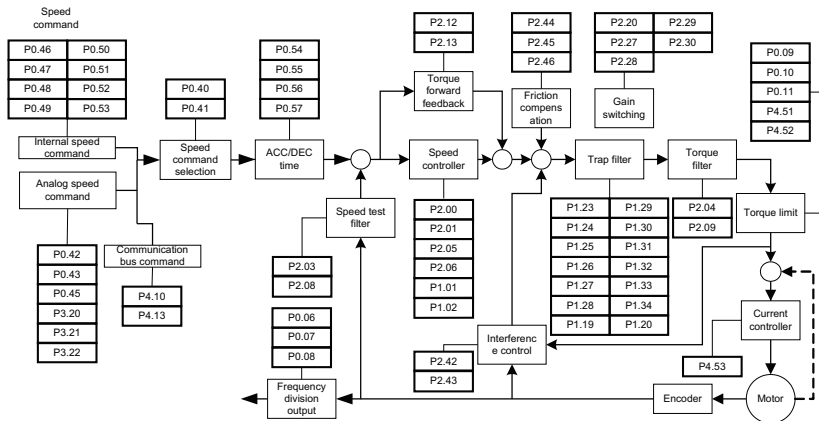

Fig. 7-2 Block diagram of speed control

The general procedures for parameter adjustment in the speed mode are:

1) Initial setting of the parameters

The defaults of the parameters can be recovered by the default parameter recovering operation (see chapter 5.2.4 for details).

2) Adjustment of the gain of the speed loop

When the servo motor is running with default parameters, if the system oscillation occurs with buzz,

the speed gain(P2.00, P2.05) should be adjusted smaller. If the system rigidity is relatively small or the speed fluctuates largely, the speed gain should be adjusted larger.

### 3) Adjustment of the speed integration time constant

When the gain of the speed loop is increased, the speed integration time constant(P2.01, P2.06) should be increased at the same time. Similarly, when the gain of the speed loop is decreased, the speed integration time constant should be decreased at the same time.

### 4) Adjustment of the ACC/DEC time

If the speed varies violently during starting, it may cause large impulse or even overcurrent. At this time we adjust the ACC time(P0.54) to smoothen the speed rise. Similarly, we can adjust the DEC time(P0.55) to smoothen the speed fall during stopping.

### 5) S curve ACC/DEC adjustment

If the requirement for smooth variation of speed can not be met by adjusting the ACC/DEC time, we can adjust the S curve ACC/DEC time(P0.56, P0.57) to make it change more smoothly.

### 6) Adjustment of the speed smoothing filter

In the case where the analog speed command is inputted, we can adjust the speed smoothing filter time constant to make the speed change smoothly.

### 7) Adjustment of speed feed-forward

If the speed follow-up performance is still poor after above parameter adjustment, we can adjust the torque feed-forward gain(P2.12) to improve the speed follow-up performance. It should be noted however that too large torque feed-forward gain may affect the stability of the system.

### 8) Adjustment of speed filter

The performance of the speed loop can be improved by adjusting P2.04/P2.09 and P2.03/P2.08.

### 9) Adjustment of trap wave filtering

See chapter 7.2.

### 10) Frequency division of the feedback pulse output

If the feedback pulse of the encoder needs to be outputted, the frequency division coefficient of pulse output can be used to change the frequency of the output pulse.

### 11) Interference control adjustment

If the gain is small, the load changes or there is sudden external interference torque, it can adjust P2.42 and P2.43 to reduce the interference and improve the performance.

12) Friction compensation adjustment If the following performance of the motor is bad during the direction changing of forward and reverse rotation, it can adjust P2.45 and P2.46 to improve the performance.

## 7.2.3 Adjustment of the gain of the torque loop

The torque control block diagram of the SV-DA200 series servo drive is shown in the figure below.

The gain parameters that can be adjusted in the torque mode are marked out on the block diagram.

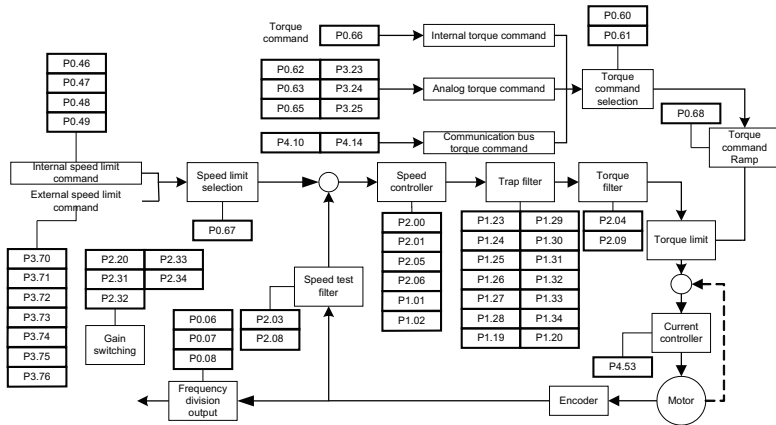

Fig. 7-3 Block diagram of torque control

The general procedures for parameter adjustment in the torque mode are:

1) Initial setting of the parameters

The defaults of the parameters can be recovered by the default parameter recovering operation (see chapter 5.2.4 for details).

2) Adjustment of the torque smoothing filter

In the case the analog torque command is inputted, we can adjust the torque smoothing filter time constant to make the torque change smoothly.

3) Frequency division of the feedback pulse output

If the feedback pulse of the encoder needs to be outputted, the frequency division coefficient of pulse output can be used to change the frequency of the output pulse.

**7.2.4 Full closed loop gain adjustment**

The gain parameters which can be adjusted are listed as the figure below:

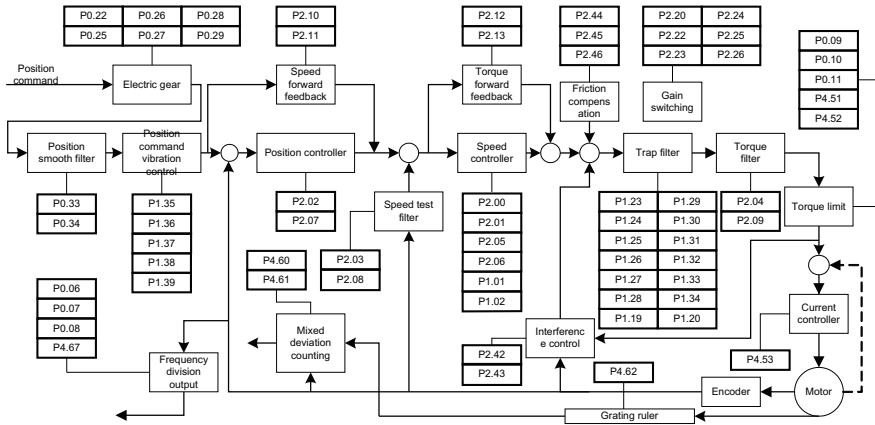

Figure 7-4 Block diagram of Full closed loop

Refer to the adjustment steps of position mode in section 7.1.1.

### 7.3 Suppression of mechanical resonance

The mechanical system has a certain resonant frequency. If the response speed of the servo is improved, the system may resonate (oscillation and abnormal noise) near the mechanical resonant frequency. The resonance of the mechanical system can be effectively suppressed by setting the parameters of the trap wave filters.

The trap wave filters achieve the goal of suppressing mechanical resonance by decreasing the gain of certain frequency. We can set the frequency to be suppressed as well as the suppression extent with relevant parameters.

The notch filter is as figure 7-2, the servo drive has four notch filters, of which, and the 3<sup>rd</sup> and 4<sup>th</sup> notch filters can be set automatically.

**Note**

The notch filter is the lag factor for the servo system, so, if the center frequency of control width is large, the vibration may be strengthened. It is recommended to increase the width unit it meets the requirements.

The relationship between the Q value, width and depth:

$$Q \text{ value of the notch wave} = \text{center frequency of the notch wave} / \text{width of the notch wave}$$

If the width of the notch is 0, the width of the filter is the deviation between two frequencies when the power of the center frequency drops to -3dB.

The width of the filter means the ratio of input and output, and the intensity attenuation  $20\log(P1.25\%, P1.28\%, P1.31\%, P1.34\%)$ dB.

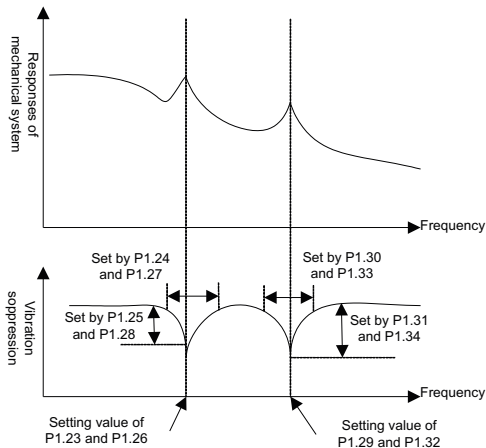

Figure 7-5 Schematic diagram of setting of the trap wave filters

### 7.4 Gain switching function

Gain switching operation is performed through internal data or external signal:

- 1) Can switch to lower gain to suppress vibration in the state when the motor is stopped (the servo is locked);
- 2) Can switch to higher gain to shorten the positioning time in the state the motor is stop;
- 3) Can switch to high gain to obtain better command follow-up performance in the state when the motor is running.
- 4) Can switch between different gain settings through external signal according to the conditions of load, equipment and so on.

●Position control and full closed loop control (●: valid, —: invalid)

Condition setting of gain switching			Parameters setting of position control and full close loop control mode		
P2.22	Switch to the 2 <sup>nd</sup> gain	Figure	Delay time*1	Level	Lag*2
			P2.23	P2.24	P2.25
0	Fixed on the 1 <sup>st</sup> gain		-	-	-
1	Fixed on the 2 <sup>nd</sup> gain		-	-	-
2	Gain switch input		-	-	-
3	Torque command	1	●	●(0.1%)	●(0.1%)
4	Speed command	3	●	●(r/min)	●(r/min)
5	Position deviation	4	●	● <sup>*3</sup> (pulse)	● <sup>*3</sup> (pulse)



6	With position command	5	●	-	-
7	Position not finished	6	●	-	-
8	Actual speed	3	●	●(r/min)	●(r/min)
9	With position command +speed command	7	●	●(r/min) <sup>*5</sup>	●(r/min) <sup>*5</sup>

## ●Speed control mode

Condition setting of gain switching			Parameters setting of speed control mode		
P2.27	Switch to the 2 <sup>nd</sup> gain	Figure	Delay time*1	Level	Lag*2
			P2.28	P2.29	P2.30
0	Fixed on the 1 <sup>st</sup> gain		-	-	-
1	Fixed on the 2 <sup>nd</sup> gain		-	-	-
2	Gain switch input		-	-	-
3	Torque command	1	●	●(0.1%)	●(0.1%)
4	Speed command variable	2	-	● <sup>*4</sup> (10(r/min)/s)	● <sup>*4</sup> (10(r/min)/s)
5	Speed command	3	●	●(r/min)	●(r/min)

## ●Torque control mode

Condition setting of gain switching			Parameters setting of torque control mode		
P2.31	Switch to the 2 <sup>nd</sup> gain	Figure	Delay time*1	Level	Lag*2
			P2.32	P2.33	P2.34
0	Fixed on the 1 <sup>st</sup> gain		-	-	-
1	Fixed on the 2 <sup>nd</sup> gain		-	-	-
2	Gain switch input		-	-	-
3	Torque command	1	●	●(0.1%)	●(0.1%)

\*1 Delay time (P2.23,P2.28,P2.32) is only valid when the 2<sup>nd</sup> gain to the 1<sup>st</sup> gain

\*2 The definition of lag (P2.25,P2.30,P2.34) is shown as the figure below.

\*3 The encoder and external grating ruler can be designated in the control mode.

\*4 If 10r/min speed changing in 1s, the setting value is 1.

\*5 If P2.22=9, the delay time, level and lag have different meaning (see figure 7).

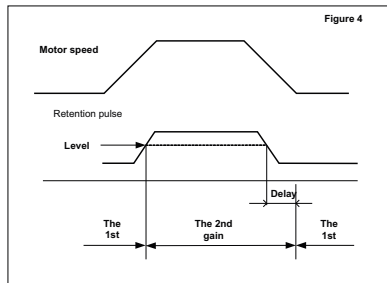
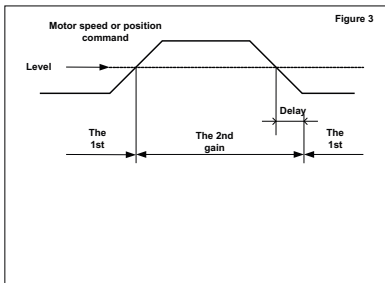
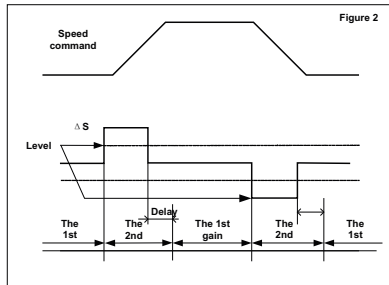
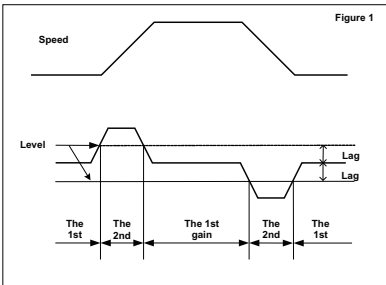
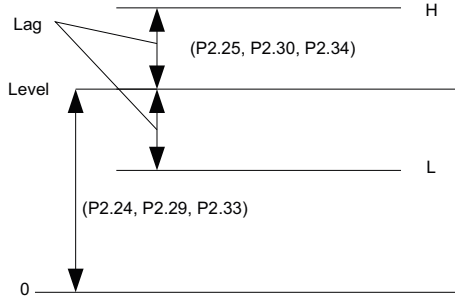

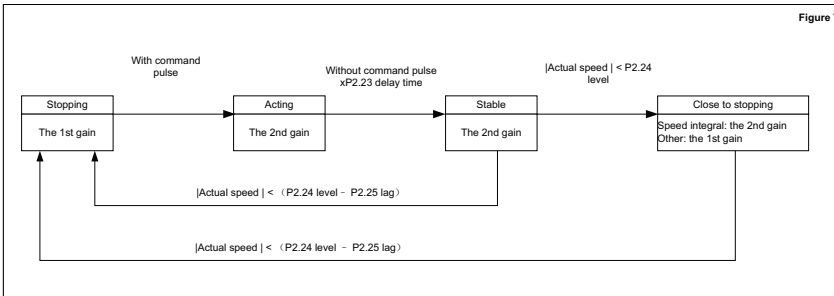
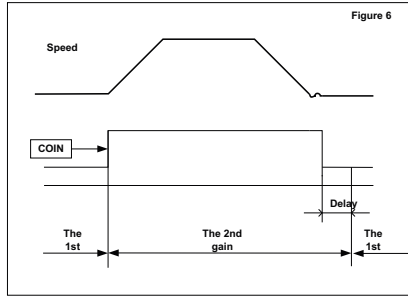
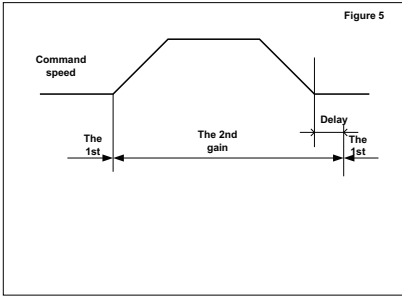

# Communication

# 8

## 8.1 Instruction

SV-DA200 servo drives provide RS485, CANopen and PROFIBUS-DP communication interface. Asynchronous serial half-duplex communication between 31 servo drives and NC or PLC is available through the RS485 interface; asynchronous serial half-duplex communication between 127 servo drives and NC or PLC is available through the CAN interface; asynchronous serial half-duplex communication between 100 servo drives and NC or PLC is available through the PROFIBUS-DP interface.

- ◆ Read/write the function parameters of the servo drives
- ◆ Monitor the operating state of the servo drives
- ◆ Form a multi-axis control system

There are three kinds of communication interface USB, CANopen and Ethernet between the servo drive and PC. And the PC has functions of parameter calibration, condition monitoring and data access to the drive. External communication card is needed for Ethernet communication.

## 8.2 RS485 communication protocol

The SV-DA200 provide RS485 communication interface. It adopts international standard ModBus communication protocol to perform master-slave communication. The user can realize centralized control through PC/PLC, upper control PC, etc. (set the control command, running frequency of the inverter, modify relevant function codes, monitor and control the operating state and fault information of the inverter and so on) to adapt specific application requirements.

### 8.2.1 Protocol content

The Modbus serial communication protocol defines the frame content and usage format in asynchronous transmission which includes: master polling, and the format of the broadcast frame and the slave answering frame. The frame of the master includes: the slave address (or the broadcast frame), commands, digit and error checkout. The slave answering also applies the same structure: action confirmation, digit returning and error checkout. If there is a mistake during the frame receiving of the slave or the slave can not finish the action which the master requires, it will respond an error frame to the master as a response.

### 8.2.2 Protocol instructions

The communication protocol of the SV-DA200 series servo drives is an asynchronous serial Master-Slave communication protocol. The master is the only device in the network to build up the protocol (named as inquiry/command), while the other devices (the slaves) can respond to or do

action to the inquiry/command of the master through providing digits. The master in this manual means PC, industrial control devices and PLC. The slaves mean the servo drives and other control devices with the same communication protocol. The master can communicate with a certain slave, as well as, send broadcast message to all slaves. For the separately-visiting inquiry/command of the master, the slave should return a message as the response. While for the broadcast message, the slave needs not to do so.

### 8.2.3 Communication protocol format

Modbus protocol supports RTU mode. The user can select whatever they prefer as well as the serial communication parameters, such as, the baud rate and the checkout means.

#### 8.2.3.1 RTU mode

When the control device is set as RTU mode, every 8bit byte in the message frame includes two 4bit hex characters.

Table 8-1: The message frame in RTU mode

The start bit	Device address	Command code	Data	LRC checkout	The tailed
T1-T2-T3-T4	8Bit	8Bit	n 8Bit(s)	16Bit	T1-T2-T3-T4

The Modbus minimum idle time between frames should be no less than 3.5 bytes. The network device is detecting, even during the interval time, the network bus. When the first field (the address field) is received, the corresponding device decodes next transmitting character. When the interval time is at least 3.5 byte, the message ends.

The whole message frame in RTU mode is a continuous transmitting flow. If there is an interval time (more than 1.5 bytes) before the completion of the frame, the receiving device will renew the uncompleted message and suppose the next byte as the address field of the new message. As such, if the new message follows the previous one within the interval time of 3.5 bytes, the receiving device will deal with it as the same with the previous message. If these two phenomena all happen during the transmission, the CRC will generate a fault message to respond to the sending devices.

### 8.2.4 Command code and the communication data instructions

#### 8.2.4.1 Command code: 03H

Function: read N words (can read no more than 16 words continuously).

For example, the servo drive with the slave address of 01H, if its starting address is 03F2H, read 2 words continuously, and then the structure of the frame is:

Table 8-2 The RTU master device request command

START	T1-T2-T3-T4 (transmission time of 3.5 bytes)
ADDR	01H

CMD	03H
High bit of start address	03H
Low bit of start address	F2H
High bit of data number	00H
Low bit of data number	02H
Low bit of CRC CHK	65H
High bit of CRC CHK	BCH
END	T1-T2-T3-T4 (transmission time of 3.5 bytes)

Table 8-3 The RTU slave device reply

START	T1-T2-T3-T4 (transmission time of 3.5 bytes)
ADDR	01H
CMD	03H
Byte number	04H
Higher bit of 03F2H	00H
Low bit of 03F2H	C8H
High bit of 03F3H	00H
Low bit of 03F3H	00H
Low bit of CRC CHK	7BH
High bit of CRC CHK	CDH
END	T1-T2-T3-T4 (transmission time of 3.5 bytes)

#### 8.2.4.2 Command code: 10H

Function: write N words (N≥2)

For example, write 300(0000012CH) into address 03F2H, slave device address 01H. And then the structure of the frame is:

Table 8-4 The RTU master device request command

START	T1-T2-T3-T4 (transmission time of 3.5 bytes)
ADDR	01H
CMD	10H
High bit of data address	03H
Low bit of data address	F2H
High bit of data number	00H
Low bit of data number	02H
Byte number	04H
High bit of 1 <sup>st</sup> word of data content	01H

Low bit of 1 <sup>st</sup> word of data content	2CH
High bit of 2 <sup>nd</sup> word of data content	00H
Low bit of 2 <sup>nd</sup> word of data content	00H
Low bit of CRC CHK	A9H
High bit of CRC CHK	F7H
END	T1-T2-T3-T4 (transmission time of 3.5 bytes)

Table 8-5 The RTU slave device reply command

START	T1-T2-T3-T4 (transmission time of 3.5 bytes)
ADDR	01H
CMD	10H
High bit of start address	03H
Low bit of start address	F2H
High bit of data number	00H
Low bit of data number	02H
Low bit of CRC CHK	E0H
High bit of CRC CHK	7FH
END	T1-T2-T3-T4 (transmission time of 3.5 bytes)

### 8.2.5 Error checkout of the communication frame

The error checkout of the frame can be divided into two parts: the bit checkout of the byte and the whole data checkout of the frame (CRC check or LRC check).

#### 8.2.5.1 Bit checkout of the byte

The user can select different bit checkouts or non-checkout, which impacts the check bit setting of each byte.

The definition of even checkout: add an even check bit before the data transmission to illustrate the number of "1" in the data transmission is odd number or even number. When it is even, the check byte is "0", otherwise, the check byte is "1". This method is used to stabilize the parity of the data.

The definition of odd checkout: add an odd check bit before the data transmission to illustrate the number of "1" in the data transmission is odd number or even number. When it is odd, the check byte is "0", otherwise, the check byte is "1". This method is used to stabilize the parity of the data.

For example, when transmitting "11001110", there are five "1" in the data. If the even checkout is applied, the even check bit is "1"; if the odd checkout is applied; the odd check bit is "0". The even and odd check bit is calculated on the check bit position of the frame. And the receiving devices also carry out even and odd checkout. If the parity of the receiving data is different from the setting value, there is an error in the communication.

### 8.2.5.2 CRC CRC check

The checkout uses RTU frame format. The frame includes the frame error detection field which is based on the CRC calculation method. The CRC field is two bytes, including 16 figure binary values. It is added into the frame after calculated by transmitting device. The receiving device recalculates the CRC of the received frame and compares them with the value in the received CRC field. If the two CRC values are different, there is an error in the communication.

During CRC, 0\*FFFF will be stored. And then, deal with the continuous 6-above bytes in the frame and the value in the register. Only the 8Bit data in every character is effective to CRC, while the start bit, the tailed and the odd and even check bit is ineffective.

The calculation of CRC applies the international standard CRC checkout principles. When the user is editing CRC calculation, he can refer to the relative standard CRC calculation to write the required CRC calculation program.

## 8.2.6 Fault Responses

The slave uses functional code fields and fault addresses to indicate it is a normal response or some error occurs (named as objection response). For normal responses, the slave shows corresponding function codes, digital address or sub-function codes as the response. For objection responses, the slave returns a code which equals the normal code, but the first byte is logic 1.

**Example:** When the master sends a message to the slave, requiring it to read a group of address data of servo device function codes, there will be following function codes:

0 0 0 0 0 1 1 (Hex 03H)

For normal responses, the slave responds the same codes, while for objection responses, it will return:

1 0 0 0 0 1 1 (Hex 83H)

Besides the function codes modification for the objection fault, the slave will respond a byte of abnormal code which defines the error reason.

When the master receives the response for the objection, in a typical processing, it will send the message again or modify the corresponding order.

Table 8-6 Meaning of error code

Modbus abnormal code		
Code	Name	Meaning
01H	Illegal function	Receiving function codes from the upper devices is not allowable. This may because these function codes can only be applied to new devices or the slave device is dealing with this requirement in a wrong situation.
02H	Illegal digital	For servo drives, the requirement digital address is not allowable;



Modbus abnormal code		
Code	Name	Meaning
	address	especially the mix of the register address and transmitting byte numbers is invalid.
03H	Illegal digital value	The digital value received is beyond the range of address parameters, leading the parameter modification invalid.
11H	Check error	In the frame message sent by the upper devices, if the CRC check bit of RTU format or the LRC check bit of ASCII format is different from the check number calculated by the below devise, an check error will be reported.

## 8.3 CANopen communication protocol

### 8.3.1 CANopen instructions

CANopen is the high level communication protocol on the control area network, includes the applications communication agreement and equipment sub-agreement in embedded system. The basic CANopen devices and sub communication protocols are in CAN in Automation (CiA) draft standard 301. And there are some expansion for some sub-agreement based on CiA 301, for example, CiA 402 for dynamic control.

### 8.3.2 CANopen hardware configuration

Refer to section 3.6 for the definitions and functions of pins of CAN communication terminals.

See the table below:

Baud rate	Communication length
1Mbit/s	25m
500kbit/s(default)	100m
250kbit/s	250m
125kbit/s	500m
50kbit/s	1000m
20kbit/s	2500m

#### Note:

1. All CANL and CANH pins of the slave station can be connected directly with series connection other than y connection.
2. The resistance of 120 ohms is needed between the master station end and the last node.
3. In order to avoid interference, CAN cable is shielded twisted-pair cable.
4. The longer connection needs higher drive ability of the CAN chip.

### 8.3.3 CANopen software configuration

Configure following three parameters before the application of CANopen:

1. Set P0.03 through LED panel or ServoPlover software to 7;
2. Set P4.02 through LED panel or ServoPlover software(0:1Mbps; 1:500kbps; 2: 250kbps; 3:125kbps; 4:50kbps; 5:20kbps);
3. Set P4.05 through LED panel or ServoPlover software(range:1~127)

#### Note:

1. Above three parameters are valid after restarting, so it is necessary to repower again or reset the drive.
2. The node number of slave station can not be the same as the node number of master station and other slave station (CNC or PLC).
3. Synchronous signal is generated by the master station or be configured by the slave station. The unit of synchronous communication cycle is 1us and the minimum unit of SV-DA200 is 1000 us (1ms);
4. 0x1017 parameters is needed to be configured when the main station needs the slave station to send a heartbeat message, the Unit is 1ms;
5. The drive will shut down automatically to ensure safety when CANopen state machine exits from OP state.

### 8.3.4 CANopen functions

SV-DA200 servo drive is the standard slave station of CANopen and support some parameters of 301 standard protocol and 402 dynamic control protocol.

The basic protocol supporting CANopen: NMT, SYNC, SDO, PDO, EMCY.

The pre-definition collection includes 4 receiving PDO (Receive-PDO), 4 sending PDO(Transmit-PDO), 1 SDO(occupying 2 CAN-ID), 1 emergency target and 1node error control (Node-Error-Control)ID, and it also supports NMT-Module-Control service and SYNC signal.

Table 8-7 Specifications of CiA 402 protocol

Index	Object Type	Name	Data Type	Access	Mappable
6040 <sub>h</sub>	VAR	Control word	UNSIGNED16	RW	Y
6041 <sub>h</sub>	VAR	Status word	UNSIGNED16	RO	Y
6042 <sub>h</sub>	VAR	vl target velocity	INTEGER16	RW	Y
6043 <sub>h</sub>	VAR	vl velocity demand	INTEGER16	RO	Y
6044 <sub>h</sub>	VAR	vl control effort	INTEGER16	RO	Y
6046 <sub>h</sub>	ARRAY	vl velocity min max amount	UNSIGNED32	RW	Y

Index	Object Type	Name	Data Type	Access	Mappable
6047 <sub>h</sub>	ARRAY	vl velocity min max	UNSIGNED32	RW	Y
6048 <sub>h</sub>	RECORD	vl velocity acceleration	UNSIGNED32	RW	Y
6049 <sub>h</sub>	RECORD	vl velocity deceleration	UNSIGNED32	RW	Y
6060 <sub>h</sub>	VAR	Mode of operation	INTEGER8	RW	Y
6061 <sub>h</sub>	VAR	Mode of operation display	INTEGER8	RO	Y
6062 <sub>h</sub>	VAR	Position demand value	INTEGER32	RO	Y
6063 <sub>h</sub>	VAR	Position actual value*	INTEGER32	RO	Y
6064 <sub>h</sub>	VAR	Position actual value	INTEGER32	RO	Y
6065 <sub>h</sub>	VAR	Following error window	UNSIGNED32	RW	Y
6066 <sub>h</sub>	VAR	Following error time out	UNSIGNED16	RW	Y
6067 <sub>h</sub>	VAR	Position window	UNSIGNED32	RW	Y
6069 <sub>h</sub>	VAR	Velocity sensor actual value	INTEGER32	RO	Y
606B <sub>h</sub>	VAR	Velocity demand value	INTEGER32	RO	Y
606C <sub>h</sub>	VAR	Velocity actual value	INTEGER32	RO	Y
606D <sub>h</sub>	VAR	Velocity window	UNSIGNED16	RW	Y
606F <sub>h</sub>	VAR	Velocity threshold	UNSIGNED16	RW	Y
6071 <sub>h</sub>	VAR	Target torque	INTEGER16	RW	Y
6072 <sub>h</sub>	VAR	Max torque	UNSIGNED16	RW	Y
6073 <sub>h</sub>	VAR	Max current	UNSIGNED16	RO	Y
6074 <sub>h</sub>	VAR	Torque demand value	INTEGER16	RO	Y
6075 <sub>h</sub>	VAR	Motor rated current	UNSIGNED32	RO	Y
6076 <sub>h</sub>	VAR	Motor rated torque	UNSIGNED32	RO	Y
6077 <sub>h</sub>	VAR	Torque actual value	INTEGER16	RO	Y
6078 <sub>h</sub>	VAR	Current actual value	INTEGER16	RO	Y
6079 <sub>h</sub>	VAR	DC link circuit voltage	UNSIGNED32	RO	Y
607A <sub>h</sub>	VAR	Target position	INTEGER32	RW	Y
607C <sub>h</sub>	VAR	Home offset	INTEGER32	RW	Y

Index	Object Type	Name	Data Type	Access	Mappable
607D <sub>h</sub>	ARRAY	Software position limit	INTEGER32	RW	Y
6080 <sub>h</sub>	VAR	Max motor speed	UNSIGNED32	RW	Y
6081 <sub>h</sub>	VAR	Profile velocity	UNSIGNED32	RW	Y
6083 <sub>h</sub>	VAR	Profile acceleration	UNSIGNED32	RW	Y
6084 <sub>h</sub>	VAR	Profile deceleration	UNSIGNED32	RW	Y
6085 <sub>h</sub>	VAR	Quick stop deceleration	UNSIGNED32	RW	Y
6086 <sub>h</sub>	VAR	Motion profile type	INTEGER16	RO	Y
6087 <sub>h</sub>	VAR	Torque slope	UNSIGNED32	RW	Y
6088 <sub>h</sub>	VAR	Torque profile type	INTEGER16	RO	Y
6093 <sub>h</sub>	ARRAY	Position factor	UNSIGNED32	RW	Y
6098 <sub>h</sub>	VAR	Homing method	INTEGER8	RW	Y
6099 <sub>h</sub>	ARRAY	Homing speeds	UNSIGNED32	RW	Y
60C0 <sub>h</sub>	VAR	Interpolation sub mode select	INTEGER16	RO	Y
60C1 <sub>h</sub>	ARRAY	Interpolation data record	INTEGER32	RW	Y
60C2 <sub>h</sub>	RECORD	Interpolation time period	INTEGER8	RW	Y
60F4 <sub>h</sub>	VAR	Following error actual value	INTEGER32	RO	Y
60F8 <sub>h</sub>	VAR	Max slippage	INTEGER32	RW	Y
60FA <sub>h</sub>	VAR	Control effort	INTEGER32	RO	Y
60FC <sub>h</sub>	VAR	Position demand value*	INTEGER32	RO	Y
60FD <sub>h</sub>	VAR	Digital inputs	UNSIGNED32	RO	Y
60FE <sub>h</sub>	ARRAY	Digital outputs	UNSIGNED32	RO	Y
60FF <sub>h</sub>	VAR	Target velocity	INTEGER32	RW	Y

Table 8-8 CANopen fault code

Display	Fault name	32-bit fault code (16-bit ErrorCode + 16 additional information)
Er01-0	IGBT fault	FF01-0101h
Er02-0	Encoder fault–The encoder wire break	7300-0200h
Er02-1	Encoder fault–Encoder feedback error is too large	7300-0201h
Er02-2	Encoder fault–Parity error	7300-0202h
Er02-3	Encoder fault–CRC error	7300-0203h
Er02-4	Encoder fault–Frame error	7300-0204h
Er02-5	Encoder fault–A short frame error	7300-0205h
Er02-6	Encoder fault–Encoder overtime	7300-0206h
Er02-7	Encoder fault–FPGA overtime	7300-0207h
Er02-8	Encoder fault–Low voltage alarm of the encoder	7300-0208h
Er02-9	Encoder fault–Undervoltage alarm of the encoder	7300-0209h
Er02-a	Encoder fault–Encoder temperature	7300-020Ah
Er02-b	Encoder fault–EEPROM error	7300-020Bh
Er03-0	Current sensor fault–U IGBT fault	7300-0300h
Er03-1	Current sensor fault–V IGBT fault	7300-0301h
Er03-2	Current sensor fault–W IGBT fault	7300-0302h
Er04-0	System initialization fault	FF01-0400h
Er05-1	Setting fault–Motor model error	FF01-0501h
Er05-2	Setting fault–Motor and drive model error	FF01-0502h
Er05-3	Setting fault–Software limit setting error	FF01-0503h
Er05-4	Setting fault–Back to the origin of fault settings	FF01-0504h
Er05-5	Setting fault–Position control overflow fault	FF01-0505h
Er07-0	Regeneration of discharge overload fault	7100-0700h
Er08-0	Analog input overvoltage fault–Analog speed command	5441-0800h
Er08-1	Analog input overvoltage fault–Analog torque command	5442-0801h
Er08-2	Analog input overvoltage fault–Analog input 3	5443-0802h

Display	Fault name	32-bit fault code (16-bit ErrorCode + 16 additional information)
Er09-0	EEPROM fault–Read-write fault	5530-0900h
Er09-1	EEPROM fault–data verification fault	5530-0901h
Er10-0	Hardware fault–FPGA fault	5544-0A00h
Er10-1	Hardware fault–Communication card fault	5544-0A01h
Er10-2	Hardware fault–Ground short circuit fault	5544-0A02h
Er10-3	Hardware fault–External input fault	5544-0A03h
Er10-4	Hardware fault–E-stop fault	4458-0A04h
Er11-1	Software fault–Reentrant cycle mission	6100-0B01h
Er11-2	Software fault–Illegal operation	6100-0B02h
Er12-0	IO fault–Repeat switch input and distribution	FF01-0C00h
Er12-2	IO fault–Pulse input frequency is too high	FF01-0C01h
Er13-0	Main circuit overvoltage fault	3110-0D00h
Er13-1	Main circuit undervoltage fault	3120-0D01h
Er14-0	Undervoltage control power supply fault	5200-0E00h
Er18-0	Motor overload fault	2310-1200h
Er19-0	Speed fault–Overspeed fault	7180-1300h
Er20-0	Speed deviation fault	8400-1400h
Er22-0	Deviation fault–Position deviation	8500-1600h
Er22-1	Deviation fault–Hybrid control deviation is too large	FF01-1601h
Er22-2	Position increment fault	FF01-1602h
Er22-3	CANopen fault–Sync signal timeout	FF01-1603h
Er23-0	The drive thermal fault	4210-1700h
Er24-0	PROFIBUS-DP fault–PWK parameters ID error	8100-1800h
Er24-1	PROFIBUS-DP fault–PWK Parameters beyond the range	8100-1801h
Er24-2	PROFIBUS-DP fault–PWK Parameters are read-on	8100-1802h
Er24-3	PROFIBUS-DP fault–PZD Configuration parameter does not exist	8100-1803h
Er24-4	PROFIBUS-DP fault–PZD Configuration	8100-1804h

Display	Fault name	32-bit fault code (16-bit ErrorCode + 16 additional information)
	parameter properties do not match	
Er25-6	Application fault–Offside of back to the origin	FF01-1903h
Er25-7	Application fault– Moment of inertia identification failure	FF01-1903h
Er26-0	CANopen fault–SDO overtime	FF01-1A00h
Er26-1	CANopen fault–SDO index does not exist	FF01-1A01h
Er26-2	CANopen fault–SDO sub index does not exist	FF01-1A02h
Er26-3	CANopen fault–SDO block length error	FF01-1A03h
Er26-4	CANopen fault–SDO beyond the scope of written data	FF01-1A04h
Er26-5	CANopen fault–Read-only	FF01-1A05h
Er26-6	CANopen fault–PDO mapping length error	FF01-1A06h
Er26-7	CANopen fault–PDO mapping data does not exist	FF01-1A07h
Er26-8	CANopen fault–PDO is not allowed to be changed during operating	FF01-1A08h
Er26-9	CANopen fault–PDO mapping is not allowed	FF01-1A09h
Er26-a	CANopen fault–Sync signal is too fast	FF01-1A0Ah
Er26-b	CANopen fault–Receive fault	FF01-1A0Bh
Er26-c	CANopen fault–Send failure	FF01-1A0Ch
Er26-d	CANopen fault–Sync signal repeat	FF01-1A0Dh
Er26-e	CANopen fault–The bus load rate is too high	FF01-1A0Eh
Er26-f	CANopen fault–Parameter state changes error	FF01-1A0Fh

## 8.4 PROFIBUS-DP communication protocol

### 8.4.1 PROFIBUS-DP instructions

PROFIBUS is a fieldbus standard used in automation technology and in 1987 promoted by Germany's Siemens and other 14 companies and five research institutions. PROFIBUS is short for PROcess Field BUS.

PROFIBUS DP is used in factory automation applications, can control many sensors and actuators by a central controller and can master the state of each module by the standard or choose diagnostic function.

### 8.4.2 PROFIBUS-DP hardware

The front side of PROFIBUS-DP communication card is as the figure below:

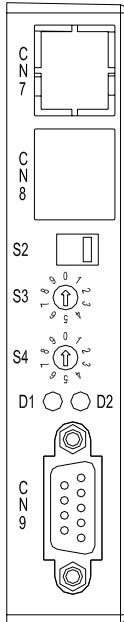

Name	Meaning
S2	PROFIBUS-DP communication terminal resistance selection switch: Press down: terminal resistance valid Hold on: terminal resistance invalid
S3	PROFIBUS-DP setting button of station address: ten
S4	PROFIBUS-DP setting button of station address: one
D1	PROFIBUS-DP diagnostic lights (red): Keep on: PROFIBUS-DP communication offline; Flicker (frequency 1Hz): configuration failure Flicker (frequency 2Hz): parameters configuration failure Flicker (frequency 4Hz): ASIC initialization failure; Off: PROFIBUS-DP communication online and trouble-free.
D2	PROFIBUS-DP communication On-Line status indicators (green): On: online Off: offline
CN7,CN8	Ethernet/EtherCAT communication interface
CN9	PROFIBUS-DP communication interface

Scope of profibus-dp communication rate is from 9.6Kbps to 12Mbps, which corresponds to the transmission distance of the range from 100m to 1200m:

Baud rate	Communication length
12Mbit/s	100m
1.5Mbit/s(default)	200m
500kbit/s	400m
187.5kbit/s	1000m
93.75kbit/s	1200m
19.2kbit/s	1200m
9.6kbit/s	1200m



**Note:**

1. PROFIBUS-DP communication card provide two rotary switched to set the communication address on PROFIBUS-DP network. These two rotary switches of binary are used to set the one and ten figure of the communication. The valid range of the communication address is 0~99 and after modification, it is necessary to repower on.
2. It is necessary to use 150Ω twisted pair cables according to the electric transmission mode of EIA-485 standards.
3. The last node between the master station and the slave station needs to connect a terminal resistance as the figure below:

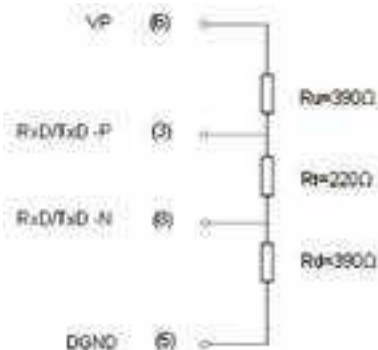

4. The bus transmission baud rate can be identified automatically after the power on of PROFIBUS-DP communication card.

**8.4.3 PROFIBUS-DP software configuration**

“Master-slave” mode is available between the data transmission between the main control module and slave control module and SV-DA200 servo drive is always the slave. In real-time control, the cycle data is used for the command setting and state monitoring and the non-cycle communication function is used for the diagnosis and troubleshooting of the data transmission.

The drive control needs parameter and process data. The non-cycle data is used to control commands and drives. The process data is cycle data for servo drive control. SV-DA200 only supports PROFIBUS-DP V0 protocol version (support PKW+PZD mode) and PPO type 5. DP-V0 is the basic communication protocol version and only supports cycle data exchange (MS0 communication). It has the basic configuration for parameters definition and diagnose.

PROFIBUS cycle transmission message applies 32 Byte transmission modes and the data format is as below:

0~7(Byte)	8~31(Byte)
PKW	PZD

Of which, PKW is used for the transmission of non-cycle data for the configuration of drive

parameters and for the read-write operation. PZD is used on the transmission of cycle data, such as control word, speed command, position command, torque command or state word, speed response, position response, torque response; PZD data can be used for the data of transmission configuration parameters.

**PKW message format:**

PKW								
PKW number(Byte)	1	2	3	4	5	6	7	8
	PKE		IND* <sup>1</sup>		PWE			

\*<sup>1</sup>: IND is the communication ID (the same as Modbus communication address), PWE is the parameter value.

**Format of PKE message:**

PKE																
Bit	15	14	13	12	11	10	9	8	7	6	5	4	3	2	1	0
	AK (task or answer ID)				SPM (reserved as 0)		Reserved									

**AK task ID:**

Master station → slave station		Slave station → main station	
ID	Function	Positive response ID	Negative response ID
0	No task	0	0
1	Read parameters	1, 2	7
2	Write parameters(single word)	1	7
3	Write parameters(double word)	2	7
13	Write parameters(single word) save EE	1	7
14	Write parameters(double word) save EE	2	7

**PZD message format:**

PZD												
WORD*1	0	1	2	3	4	5	6	7	8	9	10	11
Down	CW	Speed command	Position command*2		Torque command	Reserved	Configuration setting Parameter 1		Configuration setting Parameter 2		Configuration setting Parameter 3	
		Speed feedback	Position feedback		Torque feedback		Configuration feedback Parameter 1		Configuration setting Parameter 2		Configuration setting Parameter 3	
Up	SW	Speed feedback	Position feedback		Torque feedback	Reserved	Configuration feedback Parameter 1		Configuration setting Parameter 2		Configuration setting Parameter 3	

\*1: the length of WORD is 16bit.

\*2: the fixed content of PZD is: the position command is P4.12; the speed command is P4.13; the torque command is P4.14, the speed feedback is R0.21, the position feedback is R0.02 and the torque feedback is R0.06.

The meaning of each bit is as the table below:

Bit	Function
0	Digital input shield (0: digital input valid; 1: CW valid) *1
1	Servo enable
2	Fault clear
3	E-stop
4	Positive drive disabled
5	Negative drive disabled
6	HOME switch signal
7	HOME trigger
8	Control mode switch
9	Gain switch
10	Inertia ratio switch
11	Torque limit switch
12	Zero speed clamp
13	Retention pulse clear
14	Vibration control switch
15	Reserved

\*1: When Bit0 is set to be 0, the internal software will use digital input as the source of the corresponding function; when it is 1, the digital input is shielded and the corresponding control bit is used as the function source.

The meaning of each bit is as the table below:

Bit	Function
0	Servo ready output
1	Servo operation output
2	Fault output
3	Alarm output
4	External breaker clear
5	Position command or not
6	Positioning finished
7	Control mode switching state
8	Speed matching
9	Speed reaching
10	Speed limiting
11	Speed command or not
12	Speed zero output
13	Torque limiting
14	Zeroing finished
15	PZD controlling

**Note:**

1. All used words and double-words are transmitted by the format of **Big-Endian**, which means the high byte or high word will be transmitted and then the low byte or low word.
2. PZD configuration parameters include setting parameters and feedback parameters for the designated parameter content. The corresponding parameters can be designated by P4.80, P4.81, P4.82, P4.83, P4.84 and P4.85.
3. GSD is a word file for the identification of PROFIBUS-DP device. GSD file includes the data information of a DP slave on the standard DP master station. GSD file has vendor information, supports communication transmission ratio, time information, characters, optional parts and I/O information as the base of master station parameters. The user can download GSD file on the company website for networking.

## 8.5 PC software

### 8.5.1 ServoPlover software

ServoPlover V4.0 is the PC monitoring and commissioning software of DA200 servo drive with following functions:

1. Real-time monitoring to the state parameters
2. Online modification of the parameters setting
3. To support USB, 4-channel waveform monitoring, the minimum resolution is 0.125ms
4. Bulk parameters saved to folders and downloaded to servo drives
5. Fault display and fault record reading
6. Multiple independent functional application interfaces (for example: frequency feature test, inertia identification, program JOG, ECAM, etc.)

### 8.5.2 Hardware

CPU	Above Pentium 4
Internal storage	More than 1G
Hard disk	More than 512M
Screen resolution	More than 1024*768
Communication interface	USB1.1

### 8.5.3 Software

Operation system	Windows XP,Vista,Windows7
.NET version	.NET Framework 4.0
Excel version	Excel2007, 2010 or above

### 8.5.4 Communication connection

The drive has USB interfaces through which the drive and the computer can be connected. The communication connection is as the figure below:

Connection	Operation	Instruction
Micro USB wire	Standard Micro-USB wire 	After power on, the USB wire can connect with the computer and to install the designated drive program

### 8.5.5 Software installation and operation

(The software installation program INVT ServoPlover V4.0 can be downloaded from the website of our company: [http://www.invt-tech.com/products\\_187\\_12.html](http://www.invt-tech.com/products_187_12.html)) During installation, automatically detect whether the user computer needs necessary plug-ins and pop up corresponding prompt messages. Ensure the software and hardware configuration of the computer meets the requirements in 8.5.2 and 8.5.3 before using.

The USB device drive program of the drive is in the drive folder in the directory of software installation

(path: ..\ServoPlorer\Drive\USB drive\). If necessary, the operation procedures for installing drive program in manual are as follows: My computer->Hardware device manager->Update drive program->Open the folder where the drive program is->Select the folder labeled in the red box below

名称	大小	类型
win324		文件夹
i654		文件夹
license		文件夹
x86		文件夹
dirs		文件夹
installer_x64.exe	1 KB	文件
installer_x86.exe	25 KB	应用程序
installer_x86.exe	23 KB	应用程序
kinwayUSB.inf	6 KB	安装信息

When starting ServoPlorer software, double click ServoPlorer.exe in the directory of software installation as follows:

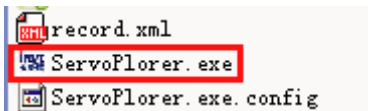

After starting the program, pop up a start-up interface and then the main interface of the software.



### 8.5.6 Program interface

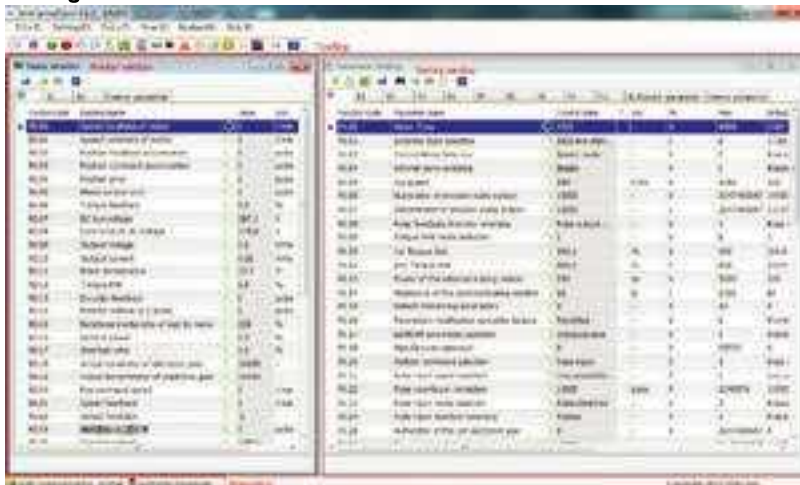

The main interface includes four parts:

1. Menu bar and Tool strip, all kinds of interface and function of the entrance
2. Condition monitoring page on the left of main interface is used to monitor real-time feedback of status parameters
3. The parameter settings page on the right of main interface is used to modify the setting parameters
4. Display the current communication mode, communication condition, fault status and the information such as user permissions

### 8.5.7 Parameter setting

1. Find the line to the parameters to be modified in the parameter setting interface
2. Click the current value twice, if the permission is allowed, the corresponding bar will appear and then input right value
3. Send the modified parameters to the drive by two methods
  - a. Press carriage return at the edition window
  - b. Click the sending button [  ]

Function Code	Parameter Name	Current Value	Unit	Min	Max	Default
P0.03	Control Mode Selection	2300 mode	-	0	7	Position mode
P0.00	Motor Type	2300	-	0	9999	2300

### 8.5.8 Help file

The software has the help file of chm format, including the operation instruction and detailed parameter information for the corresponding help.

The main window has the access to general documentation and the help button of each window can

lead the user to relative chapter.

### 8.5.9 Oscilloscope

The oscilloscope function can be started by the oscilloscope button or the route of menu bar ->tool->oscilloscope.

#### User interface



There are five areas:

1. Waveform display area: Draw waveform and auxiliary display elements, such as the cursor, gain, etc.
2. Channel selection area: Choose the display content of the channel monitoring, support parameter selection and two modes of the internal variable function codes
3. Display control area:
  - a. Managing interface: Control the starting, stopping, moving and magnifying of the oscilloscope waveform and the displaying of the cursor, zero and trigger threshold;
  - b. Page replay interface: Be used in the USB trigger mode and waveform file restoring mode, including the function of starting, stopping, and moving and position selection;
  - c. File operations interface: Saving and restoring of csv waveform file and the figures;
4. Communication control area: Control the starting and stopping of the oscilloscope communication, saving of the channel data, switching of the high-speed and low-speed oscilloscope (valid in the USB mode), setting in the trigger mode and help.
5. Information display area: Display the name of the current monitored content, display or hide the result and so on.



# Fault process

# 9

## 9.1 Meanings of the fault alarm codes and countermeasures

Code	Name	Causes	Countermeasures
Er01-0	IGBT fault	<p>The actual output current exceeds the specified value</p> <ol style="list-style-type: none"> <li>1. Drive fault (drive circuit, IGBT fault)</li> <li>2. Short circuit of motor cable U, V, W, or the motor cable is not connected well</li> <li>3. Motor Burnout</li> <li>4. Reverse sequence of U, V, W phase</li> <li>5. System parameters are not appropriate to spread.</li> <li>6. ACC/DEC of start-stop process is too short</li> <li>7. Instantaneous load is too large</li> </ol>	<ol style="list-style-type: none"> <li>1. Remove the motor cables and enable the drive, if not available, change the drive</li> <li>2. Check the motor cables and wiring</li> <li>3. Reduce the value of P0.10 and P0.11</li> <li>4. Commission the loop parameters and reduce the value of P0.12</li> <li>5. Longer the ACC/DEC time</li> <li>6. Change to a drive with bigger power</li> <li>7. Change the motor</li> </ol>
Er02-0	Encoder fault— The encoder wire break	<ol style="list-style-type: none"> <li>1. The encoder is not connected</li> <li>2. The encoder connector becomes loose</li> </ol>	<ol style="list-style-type: none"> <li>1. Check the encoder connector or replace the encoder cable</li> </ol>
Er02-1	Encoder fault—Encoder feedback error is too large	<ol style="list-style-type: none"> <li>3. The line of one of the U, V, W, A, B, Z phases of the encoder signal cable is broken</li> </ol>	<ol style="list-style-type: none"> <li>2. Connect the encoder voltage</li> <li>3. Reduce the interference of the encoder, route the encoder and motor independently and connect the shield cables of the encoder to FG</li> </ol>
Er02-2	Encoder fault—Parity error	<ol style="list-style-type: none"> <li>4. Reversed A/B phase of the encoder</li> </ol>	<ol style="list-style-type: none"> <li>4. If reporting encoder offline fault when power on, check whether the available drive encoder type is consistent with the available motor encoder type according to P0.01.</li> </ol>
Er02-3	Encoder fault—CRC error	<ol style="list-style-type: none"> <li>5. Communication breaks or abnormal data</li> </ol>	
Er02-4	Encoder fault—Frame error	<ol style="list-style-type: none"> <li>6. Abnormal communication data</li> </ol>	
Er02-5	Encoder fault—A short frame error	<ol style="list-style-type: none"> <li>7. FPGA communication</li> </ol>	

Code	Name	Causes	Countermeasures
Er02-6	Encoder fault– Encoder overtime	overtime 8. The drive does not support the encoder type	
Er02-7	Encoder fault –FPGA overtime		
Er02-8	Encoder fault –Low voltage alarm of the encoder	If multiple circle encoder is used, the battery voltage of the external encoder is between 3.0V~3.2V	1. Check the connection of encoder battery 2. Check whether the voltage is below 3.2V, if yes, change the battery 3. Change the battery when the drive is power on; otherwise the encoder data will be loss.
Er02-9	Encoder fault –Undervoltage alarm of the encoder	If multiple circle encoder is used, the battery voltage of the external encoder is between 2.5V~3.0V	1. Check the connection of encoder battery 2. Check whether the voltage is below 3.0V, if yes, change the battery 3. Change the battery when the drive is power on; otherwise the encoder data will be loss.
Er02-a	Encoder fault –Encoder temperature	The feedback encoder temperature is higher than the setting protection value	1. Check the setting value of the overtemperature protection 2. Stop the motor and reduce the encoder temperature
Er02-b	Encoder fault– EEPROM error	If the motor is used with communication encoder, and when the drive updates the data, there is communication transmission error or data validation errors	1. Check the encoder connection and reduce the encoder interference 2. Write in for several times or change the motor
Er02-c	Encoder fault– EEPROM no data	If the motor is used with communication encoder, and when read encoder EEPROM during power on, there is no	1. Select the current motor model through P0.00 and then carry out the encoder EEPROM writing through P4.97

Code	Name	Causes	Countermeasures
		data	2. Shielded the fault by P4.98, and then carry out corresponding initialization to the motor parameters
Er02-d	Encoder fault–EEPROM polarity error	If the motor is used with communication encoder, and when read encoder EEPROM during power on, there is polarity error	1. Check the encoder connection and reduce the encoder interference 2. Select the current motor model through P0.00 and then carry out the encoder EEPROM writing through P4.97 3. Shield the fault by P4.98, and then carry out corresponding initialization to the motor parameters
Er03-0	Current sensor fault–U IGBT fault	1. Current sensor or abnormal detection circuit 2. Power on when the motor shaft is in a state of non-stationary	Repower on when the motor is in static state or change the drive
Er03-1	Current sensor fault–V IGBT fault		
Er03-2	Current sensor fault–W IGBT fault		
Er04-0	System initialization fault	The self inspection is not passed after initialization	1. Repower on 2. If the fault occurs for several times, change the drive
Er05-1	Setting fault–Motor model error	Wrong P0.00 setting	Ensure the motor model and the drive model
Er05-2	Setting fault–Motor and drive model error		
Er05-3	Setting fault–Software limit setting error	Software limit values setting is not reasonable The setting value of P0.35 is less than or equal to the setting value of P0.36	Reset P0.35 and P0.36.

Code	Name	Causes	Countermeasures
Er05-4	Setting fault–Back to the origin of fault settings	Sub mode of P5.10 is set correctly	Set P5.10 to the instructions
Er05-5	Setting fault–Position control overflow fault	The single increment exceeds 231-1	The single travel can not exceed 231-1 in the position mode
Er07-0	Regeneration of discharge overload fault	<ol style="list-style-type: none"> <li>1. The power of the built-in braking resistor is relatively low</li> <li>2. The motor speed is too high or the deceleration is too short</li> <li>3. The action limit of the external braking resistor is 10% of the duty ratio</li> </ol>	<ol style="list-style-type: none"> <li>1. Connect an external braking resistor of higher power</li> <li>2. Replace with a braking resistor of higher power</li> <li>2. Modify the deceleration time</li> <li>3. Reduce the motor speed</li> <li>4. Improve the capacity of the motor and drive</li> </ol>
Er08-0	Analog input overvoltage fault–Analog speed command	1. The voltage of input analog speed command exceeds the setting value of P3.22	<ol style="list-style-type: none"> <li>1. Set P3.22,P3.25,P3.75</li> <li>2. Check the terminals wiring</li> <li>3. Set P3.22,P3.25,P3.75 to be 0 and disable the protection</li> </ol>
Er08-1	Analog input overvoltage fault–Analog torque command	<ol style="list-style-type: none"> <li>2. The voltage of input analog torque command exceeds the setting value of P3.25</li> <li>3. The voltage of input analog</li> </ol>	
Er08-2	Analog input overvoltage fault–Analog input 3	3 command exceeds the setting value of P3.75	
Er09-0	EEPROM fault–Read-write fault	<p>The data storage has damage when read write from EEPROM</p> <p>Interference to EEPROM write</p>	<ol style="list-style-type: none"> <li>1. Try again after repower on</li> <li>2. If occur for many times, change the drive</li> </ol>
Er09-1	EEPROM fault–verification fault	1. The data read from EEPROM when power on are different during writing	<ol style="list-style-type: none"> <li>1. Reset all parameters</li> <li>2. If occur for many times, change the drive</li> </ol>

Code	Name	Causes	Countermeasures
		2. The drive DSP software version updates	
Er10-0	Hardware fault– FPGA fault	FPGA chip fault	1. Repower on 2. If occur for many times, change the drive
Er10-1	Hardware fault– Communication card fault	External communication card fault	1. Repower on 2. If occur for many times, change the communication card
Er10-2	Hardware fault– Ground short circuit fault	During the earth test after power on, one of motor cables V,W is short-connected	1. Check the connection of the motor cables 2. Change the cable or test the motor is insulation aging or not
Er10-3	Hardware fault– External input fault	If configured as external fault input, the fault occurs when action	1. Clear the external fault input 2. Repower on
Er10-4	Hardware fault– E-stop fault	If configured as E-stop input, the fault occurs when action	1. Clear the E-stop input 2. Repower on
Er10-5	Hardware fault– 485 communication fault	Strong EMI of 485 communication circuit causes drive serial communication alarms	1. Use twisted shielded pairs for 485 communication 2. Arrange communication cables and motor power cables separately
Er11-0	Software fault– Motor control repeat	1. CPU loading ratio is too high 2.DSP software fault	1. Reduce the software 2. Contact with the customers service and change the DSP software
Er11-1	Software fault– Reentrant cycle mission		
Er11-2	Software fault - Illegal operation		
Er12-0	IO fault–Repeat switch input and distribution	Two or more input switches have the same functions	Reset P3.00~P3.09 and ensure no repeated setting

Code	Name	Causes	Countermeasures
Er12-1	IO fault—Repeat analog input and distribution	If the drive is standard, the analog input 3 is speed command	Reset P3.70
Er12-2	IO fault—Pulse input frequency is too high	The tested pulse input frequency is higher than the designated value 1. External input pulse signal frequency is too high. 2. Damage of internal drive pulse frequency detection circuit	1. Test whether the actual frequency exceeds the corresponding frequency of the maximum pulse of P0.21 2. Reduce the external input pulse signal frequency 3. Change the drive
Er13-0	DC fault—overvoltage fault	The DC voltage of the main circuit is higher than the designated value 1. The grid voltage is too high 2. No braking resistor or pipe during braking or the braking resistor is damaged 3. DEC time is too short during the stopping 4. The internal DC voltage test circuit is has damage	1. Check the grid input voltage 2. Check the internal braking resistor is loose or damaged 3. Enlarge the setting value of ACC/DEC time 4. Monitor R0.07 when the drive is disabled, if abnormal, change the drive
Er13-1	DC fault—undervoltage fault	The DC voltage of the main circuit is less than the designated value 1. The grid voltage is too low 2. The buffer relay is not switched on 3. The drive output power is too large 4. The internal DC voltage test circuit is has damage	1. Check the grid input voltage 2. Repower on, and note the pull-in noise of the relay 3. Monitor R0.07 when the drive is disabled, if abnormal and not matched with grid voltage, change the drive
Er14-0	Control circuit overvoltage fault	The DC voltage of the main circuit is less than the	1. Check the grid input voltage 2. Monitor R0.08 when the drive

Code	Name	Causes	Countermeasures
		designated value 1. The grid voltage is too low 2. The internal DC voltage test circuit is has damage	is disabled, if abnormal and not matched with grid voltage, change the drive
Er18-0	Motor overload fault	1. The grid voltage is low 2. The powering-up snubber relay has not picked up	1. Test the input voltage of the grid 2. Replace the drive
Er19-0	Speed fault– Overspeed fault	The absolute value of the motor speed exceeds the setting value of P4.32 1. U, V, W phases of the motor are connected reversely 2. Incorrect setting of the electronic gear ratio or motor speed loop control parameters 3.The setting value of P4.32 is less than the setting value of P4.31 4. Interference to the encoder feedback signal	1. Check the electronic gear ratio 2. Check the setting of speed loop control parameters 3. Check that the phases of the motor cable are connected correctly 4. Change the motor with higher speed
Er20-0	Speed deviation fault	In non-torque mode, the deviation exceeds the deviation of P4.39 1. U, V, W phases of the motor are connected reversely 2. The motor load is too heavy 3. Insufficient Drive output 4. Speed loop control parameters setting is not reasonable	1. Check the cable sequence and ensure right wiring 2. Check the transmission belt or chain or the platform 3. Check the parameters setting or whether the drive has damage or whether the system selection is right 4. Enlarge the setting value of P4.39 5. Set P4.39 to be 0

Code	Name	Causes	Countermeasures
		5.Small setting of P4.39	
Er22-0	Deviation fault–Position deviation	<ol style="list-style-type: none"> <li>1. Server response time is too slow and the retention pulse number exceeds the setting value of P4.33</li> <li>2. The motor load is too heavy</li> <li>3.High pulse frequency input</li> <li>4. Position command input step change exceeds the setting value of P4.33</li> </ol>	<ol style="list-style-type: none"> <li>1. Check the transmission belt or chain or the platform</li> <li>2. Enlarge the position loop gain parameters or speed feedforward gain or P4.33</li> <li>3. Adjust the electronic gear ratio parameter</li> <li>4. Minimize the variation of single position command</li> </ol>
Er22-1	Deviation fault–Hybrid control deviation is too large	In full closed loop control, the deviation exceeds the setting value of P4.64	<ol style="list-style-type: none"> <li>1.Check the connection between the motor and load</li> <li>2. Check the connection between grating ruler and the drive</li> <li>3.Check the setting of P4.60, P4.61 and P4.62</li> </ol>
Er22-2	Position increment fault	The variation of single position command exceeds $2^{31}-1$ after the convertering	<ol style="list-style-type: none"> <li>1. Minimize the variation of single position command</li> <li>2. Modify the gear ratio</li> </ol>
Er22-3	CANopen fault–Sync signal timeout	In the position mode, the time interval between two adjacent frame synchronization signal is longer than twice of the time period of communication	<ol style="list-style-type: none"> <li>1.Check the communication connection</li> <li>2. Confirm the synchronous signal of the synchronous frame interval is correct</li> </ol>
Er23-0	The drive thermal fault	<ol style="list-style-type: none"> <li>1.The operation temperature of the drive exceed the designated value</li> <li>2. Drive overload</li> </ol>	<ol style="list-style-type: none"> <li>1.Reduce the temperature and improve the environment</li> <li>2. Change to a system with bigger power</li> <li>3. Longer the ACC/DEC time and reduce the load</li> </ol>
Er25-4	Application fault–encoder offset	The encoder offset angle is abnormal during test	Check whether the motor shaft can rotate freely, then repower



Code	Name	Causes	Countermeasures
	angle test overtime		on and carry out
Er25-5	Application fault- encoder offset angle test failure	The current feedback fluctuation is large when the encoder offset angle in test	Reduce P4.53 parameter setting, then repower on and carry out
Er25-6	Application fault- Offside of back to the origin	Meet the limit switch or software limit during the returning	Modify the setting of P5.10, and then repower on and carry out
Er25-7	Application fault- Moment of inertia identification failure	1.Vibration in stopping exceeds 3.5s 2. Too short ACC time 3. The identification speed is below 150r/min	1.Improve the mechanical rigidity 2.Prolong P1.07 3.Increase P1.06

## 9.2 CANopen communication fault code and countermeasures

Code	Name	Causes	Countermeasures
Er26-0	SDO overtime	No drive response after the designated time of the master read and write SDO	Check the communication
Er26-1	SDO index does not exist	SDO read or write parameters, the corresponding index does not exist or not be supported	Check the index and modify in EDS file
Er26-2	SDO sub index does not exist	SDO read or write parameters, the corresponding sub index does not exist or not be supported	Check the index and modify in EDS file
Er26-3	SDO length error	The length of SDO read or write command is not matched	Adjust the length to the data length of drive object dictionary
Er26-4	SDO beyond the scope of written data	The range of SDO read or write command exceed the setting rage	Adjust the data length of drive object dictionary

Code	Name	Causes	Countermeasures
Er26-5	Read-only	Modify the parameters only for read	Check the parameters only for read
Er26-6	PDO mapping length error	The mapping length of PDO data exceed 64 bit	Check the mapping length
Er26-7	PDO mapping data does not exist	PDO mapping data can not be found in the object dictionary	Check PDO mapping data in the object dictionary
Er26-8	PDO not allowed to be changed in the operating	Modify the PDO mapping during operation	Switch CANOpen state to pre-operation and then modify PDO mapping
Er26-9	PDO not allow the mapping	Map the parameters not allowed	Check the PDO parameter properties
Er26-a	Sync signal too fast	The received frame exceeds the range	1.Modify the sending interval of the master station or the interval of synchronization frame 2.Modify the baud rate
Er26-b	Receive fault	CAN communication offline or received fault exceeds 128	1.Check the communication connection 2.Restart the drive
Er26-c	Send fault	CAN communication offline or received fault exceeds 128	1.Check the communication connection 2.Restart the drive
Er26-d	Sync signal repeat	Receive the synchronization signal of external input when synchronization signal is from slave station	Modify the configuration
Er26-e	Bus load rate is too high	Asynchronous work mode, the number of frames received exceeds the scope of the baud rate	1. Modify the sending interval of the master station 2. Modify the sending mode of slave station TPDO 3. Modify the baud rate
Er26-f	Parameter modification state	Modify the parameter in the state not allowed	Adjust the CANopen machine to Pre-OP or OP state, and then

Code	Name	Causes	Countermeasures
	error		try to modify the parameters
Er22-3	Sync signal timeout	In the position mode, the time interval between two adjacent frame synchronization signal is longer than twice of the time period of communication	1.Check the communication connection 2. Confirm the synchronous signal of the synchronous frame interval is correct

### 9.3 PROFIBUS-DP communication fault code and countermeasures

Code	Name	Causes	Countermeasures
Er24-0	PROFIBUS-DP fault -PWK ID error	PWK ID error	Read the manual , ensure the ID corresponds to the parameter ID
Er24-1	PROFIBUS-DP fault -PWK exceed the range	The setting of PWK exceed the range	Read the manual , ensure the PWK setting of PWK is in the range
Er24-2	PROFIBUS-DP fault -PWK only for read	PWK is only for read	Read the manual , ensure the parameter can be red and written
Er24-3	PROFIBUS-DP fault -PZD does not exist	The selected ID is not right	Read the manual , ensure the ID corresponds to the parameter ID
Er24-4	PROFIBUS-DP fault -PZD not matching	The parameter is not valid instantly	Read the manual , ensure the parameter is valid instantly

# Appendix

# 10

## 10.1 List of function parameters

P – position mode; S – speed mode; T – torque mode; F – full closed loop control

The function codes with the superscript of “1” indicate that these parameters can be valid only when the system is reset and restarted or repowered after disconnection.

The function codes with the superscript of “2” indicate that these parameters are valid when the servo drive stops. The modification during operation is invalid.

The function codes with the superscript of “\*” indicate that these parameters are not saved after power off.

Table 10-1 List of function parameters

Function code	Name	Unit	Range	Default	Mode
<b>P0 Basic control</b>					
P0.00 <sup>1</sup>	Motor model	-	0~9999	2300	PSTF
P0.01 <sup>1</sup>	Encoder type	-	1~8	4	PSTF
P0.03 <sup>1</sup>	Control mode	-	0~9	0	PSTF
P0.04*	Internal enabling command	-	0~1	0	PSTF
P0.05	Jog speed	r/min	0~1000	200	PSTF
P0.06 <sup>1</sup>	Numerator of the frequency division coefficient of encoder pulse output	-	0~(2 <sup>31</sup> -1)	10000	PSTF
P0.07 <sup>1</sup>	Denominator of the frequency division coefficient of encoder pulse output	-	1~(2 <sup>31</sup> -1)	131072	PSTF
P0.08 <sup>1</sup>	Logic reverse of pulse output	-	0~1	0	PSTF
P0.09	Torque limit mode	-	0~6	1	PSF
P0.10	Max torque limit 1	%	0.0~500.0	300.0	PSTF
P0.11	Max torque limit 2	%	0.0~500.0	300.0	PSF
P0.13 <sup>1</sup>	Power of the external braking resistor	W	0~5000	200	PSTF
P0.14 <sup>1</sup>	Resistance of the external braking resistor	Ω	1~1000	60	PSTF
P0.15	Default monitoring parameters	-	0~22	0	PSTF
P0.16	Parameter modification	-	0~1	0	PSTF

Function code	Name	Unit	Range	Default	Mode
	operation locking				
P0.17	EEPROM write mode	-	0~1	0	PSTF
P0.18*	Factory password	-	0~65535	0	PSTF
P0.20 <sup>1</sup>	Position command	-	0~3	0	PF
P0.22 <sup>1</sup>	Pulse number of a circle motor rotation	pulse	0~1048576	10000	PF
P0.23 <sup>1</sup>	Pulse input form	-	0~2	0	PF
P0.24 <sup>1</sup>	Pulse input direction reversing	-	0~1	0	PF
P0.25	Numerator of the 1 <sup>st</sup> electronic gear	-	0~(2 <sup>31</sup> -1)	0	PF
P0.26 <sup>2</sup>	Denominator of the electronic gear	-	1~(2 <sup>31</sup> -1)	10000	PF
P0.27	Numerator of the 2 <sup>nd</sup> electronic gear	-	0~(2 <sup>31</sup> -1)	0	PF
P0.28	Numerator of the 3 <sup>rd</sup> electronic gear	-	0~(2 <sup>31</sup> -1)	0	PF
P0.29	Numerator of the 4 <sup>th</sup> electronic gear	-	0~(2 <sup>31</sup> -1)	0	PF
P0.33 <sup>2</sup>	Smooth filter of position command	ms	0.0~1000.0	0.0	PF
P0.34 <sup>2</sup>	FIR filter of position command	ms	0.0~1000.0	0.0	PF
P0.35	Software limit of the forward position	-	-(2 <sup>31</sup> -1)~(2 <sup>31</sup> -1)	0	PF
P0.36	Software limit of the reverse position control	-	-(2 <sup>31</sup> -1)~(2 <sup>31</sup> -1)	0	PF
P0.37	Position command mode	-	0~1	0	PF
P0.40	Speed command	-	0~3	1	S
P0.41	Setting of speed command direction	-	0~1	0	S
P0.42	Analog speed command gain	(r/min)/V	10~2000	100	S
P0.43	Analog speed command reverse	-	0~1	0	S

Function code	Name	Unit	Range	Default	Mode
P0.45	Dead zone of analog speed command	V	0.000~3.000	0.000	S
P0.46	Internal speed 1/ Speed limit 1	r/min	-20000~20000	100	ST
P0.47	Internal speed 2/ Speed limit 2	r/min	-20000~20000	0	ST
P0.48	Internal speed 3/ Speed limit 3	r/min	-20000~20000	0	ST
P0.49	Internal speed 4/ Speed limit 4	r/min	-20000~20000	0	ST
P0.50	Internal speed 5	r/min	-20000~20000	0	S
P0.51	Internal speed 6	r/min	-20000~20000	0	S
P0.52	Internal speed 7	r/min	-20000~20000	0	S
P0.53	Internal speed 8	r/min	-20000~20000	0	S
P0.54	ACC time	ms	0~30000	0	S
P0.55	DEC time	ms	0~30000	0	S
P0.56	ACC time of S curve	ms	0~1000	0	S
P0.57	DEC time of S curve	ms	0~1000	0	S
P0.58	Zero speed clamp mode	-	0~3	0	ST
P0.59	Speed threshold of zero speed clamp	r/min	10~20000	30	S
P0.60	Torque command selection	-	0~3	1	T
P0.61	Torque command direction	-	0~1	0	T
P0.62	Analog torque command gain	0.1%/V	0~1000	100	PSTF
P0.63	Analog torque command reverse	-	0~1	0	PSTF
P0.65	Dead zone of analog torque command	V	0.000~3.000	0.000	PSTF
P0.66	Internal speed command	%	-500.0~500.0	0.0	T
P0.67	Speed limit setting	-	0~1	0	T
P0.68	RAMP time of torque command	ms	0~10000	0	T

Function code	Name	Unit	Range	Default	Mode
P0.69	DEC time of fast stop	ms	0~10000	500	PSTF
P0.70	Absolute encoder setting	-	0~1	0	PSTF
P0.71*	Absolute encoder clearing	-	0~1	0	PSTF
P0.90	Max. speed limit of the control mode switching	r/min	0~1000	100	PST
P0.91	Positioning reference of the control mode switching	pulse	-1~1048575	-1	PST
P0.92	Exiting mode of the position mode switching	-	0~1	0	PST
<b>P1 Autoturning control parameters</b>					
P1.00	On-line automatic setting	-	0~1	0	PSTF
P1.01	1 <sup>st</sup> inertia ratio	%	0~10000	250	PSTF
P1.02	2 <sup>nd</sup> inertia ratio	%	0~10000	250	PSTF
P1.03	Machine rigidity setting	-	0~31	13	PSTF
P1.04*	Inertia identification switch	-	0~1	0	PSTF
P1.05	Operation mode of inertia identification	-	0~3	0	PSTF
P1.06	Range of inertia identification	r	0.2~20.0	2	PSTF
P1.07	Time constant of ACC time	ms	2~1000	200	PSTF
P1.08	Speed level of inertia identification	-	0~3	1	PSTF
P1.19	Valid resonance detection bit	%	0.2~100	5	PSTF
P1.20	Resonance test mode	-	0~7	0	PSTF
P1.21*	1 <sup>st</sup> mechanical resonance frequency	Hz	0~5000	5000	PSTF
P1.22*	2 <sup>nd</sup> mechanical resonance frequency	Hz	0~5000	5000	PSTF
P1.23	1 <sup>st</sup> trap wave frequency	Hz	50~5000	5000	PSTF
P1.24	Q value of 1 <sup>st</sup> trap wave	-	0.50~16.00	1.00	PSTF
P1.25	1 <sup>st</sup> trap wave depth	%	0~100	0	PSTF
P1.26	2 <sup>nd</sup> trap wave frequency	Hz	50~5000	5000	PSTF
P1.27	Q value of 2 <sup>nd</sup> trap wave	-	0.50~16.00	1.00	PSTF

Function code	Name	Unit	Range	Default	Mode
P1.28	2 <sup>nd</sup> trap wave depth	%	0~100	0	PSTF
P1.29	3 <sup>rd</sup> trap wave frequency	Hz	50~5000	5000	PSTF
P1.30	Q value of 3 <sup>rd</sup> trap wave	-	0.50~16.00	1.00	PSTF
P1.31	3 <sup>rd</sup> trap wave depth	%	0~100	0	PSTF
P1.32	4 <sup>th</sup> trap wave frequency	Hz	50~5000	5000	PSTF
P1.33	Q value of 4 <sup>th</sup> trap wave	-	0.50~16.00	1.00	PSTF
P1.34	4 <sup>th</sup> trap wave depth	%	0~100	0	PSTF
P1.35	Vibration control selection	-	0~2	0	PF
P1.36	The 1 <sup>st</sup> vibration control frequency	Hz	0.0~200.0	0.0	PF
P1.37	The 1 <sup>st</sup> vibration control factor	-	0.00~1.00	1.00	PF
P1.38	The 2 <sup>nd</sup> vibration control frequency	Hz	0.0~200.0	0.0	PF
P1.39	The 2 <sup>nd</sup> vibration control factor	-	0.00~1.00	1.00	PF
<b>P2 Motor control</b>					
P2.00	1 <sup>st</sup> speed gain	Hz	0.0~3276.7	27.0	PSTF
P2.01	1 <sup>st</sup> speed integration time constant	ms	0.1~1000.0	21.0	PSTF
P2.02	1 <sup>st</sup> position gain	1/s	0.0~3276.7	48.0	PF
P2.03	1 <sup>st</sup> speed detection filter time	-	0~5	0	PSTF
P2.04	1 <sup>st</sup> torque filter	ms	0.00~25.00	0.84	PSTF
P2.05	2 <sup>nd</sup> speed gain	Hz	0.0~3276.7	27.0	PSTF
P2.06	2 <sup>nd</sup> speed integration time constant	ms	0.1~1000.0	1000.0	PSTF
P2.07	2 <sup>nd</sup> position gain	1/s	0.0~3276.7	57.0	PF
P2.08	2 <sup>nd</sup> speed detection filter time	-	0~5	0	PSTF
P2.09	2 <sup>nd</sup> torque filter	ms	0.00~25.00	0.84	PSTF
P2.10	Speed feed-forward gain	%	0.0~100.0	0.0	PF
P2.11	Speed feed-forward filter time constant	ms	0.00~60.00	0.50	PF
P2.12	Torque feed-forward gain	%	0.0~100.0	0.0	PSF
P2.13	Torque feed-forward filter time	ms	0.00~60.00	0.00	PSF



Function code	Name	Unit	Range	Default	Mode
	constant				
P2.20	2 <sup>nd</sup> gain setting	-	0~1	1	PSTF
P2.22	Position mode gain switching	-	0~9	0	PF
P2.23	Delay time of position control switching	ms	0~10000	0	PF
P2.24	Switching level of position control	-	0~20000	0	PF
P2.25	Switching delay of the position control	-	0~20000	0	PF
P2.26	Switching time of position gain	ms	0~10000	0	PF
P2.27	Switching mode of speed control	-	0~5	0	S
P2.28	Delay time of speed control switching	ms	0~10000	0	S
P2.29	Switching level of speed control	-	0~20000	0	S
P2.30	Switching delay of the speed control	-	0~20000	0	S
P2.31	Switching mode of torque control	-	0~3	0	T
P2.32	Delay time of torque control switching	ms	0~10000	0	T
P2.33	Switching level of torque control	-	0~20000	0	T
P2.34	Switching delay of the torque control	-	0~20000	0	T
P2.42	Gain compensation of disturbance torque	%	0.0~100.0	0.0	PSF
P2.43	Filter time of the disturbance observer	ms	0.00~25.00	0.53	PSF
P2.44	Torque command offset	%	-500.0~500.0	0.0	PSTF
P2.45	Friction compensation of forward torque	%	-500.0~500.0	0.0	PSF

Function code	Name	Unit	Range	Default	Mode
P2.46	Friction compensation of negative torque	%	-500.0~500.0	0.0	PSF
P2.47*	Factor setting of alveolar pulsating torque compensation	-	0~1	0	PSF
P2.48	Gain of alveolar pulsating torque compensation	%	0~100.0	0	PSF
P2.60	Validation of the speed observer	-	0~2	0	PSTF
P2.61	Gain of the speed observer	Hz	1~500	100	PSTF
P2.62	Gain of the phase comparator	%	0~1000	100	PSTF
P2.63	Time constant of the torque filter	0.01ms	0~65535	100	PSTF
P2.70	The absolute value encoder speed mode	-	0~1	0	PSTF
P2.71	Filter level of absolute encoder	-	0~6	0	PSTF
<b>P3 I/O management</b>					
P3.00 <sup>1</sup>	Configuration 1 of digital input	-	0x000~0x11E	0x003	PSTF
P3.01 <sup>1</sup>	Configuration 2 of digital input	-	0x000~0x11E	0x00D	PSTF
P3.02 <sup>1</sup>	Configuration 3 of digital input	-	0x000~0x11E	0x004	PSTF
P3.03 <sup>1</sup>	Configuration 4 of digital input	-	0x000~0x11E	0x016	PSTF
P3.04 <sup>1</sup>	Configuration 5 of digital input	-	0x000~0x11E	0x019	PSTF
P3.05 <sup>1</sup>	Configuration 6 of digital input	-	0x000~0x11E	0x01A	PSTF
P3.06 <sup>1</sup>	Configuration 7 of digital input	-	0x000~0x11E	0x001	PSTF
P3.07 <sup>1</sup>	Configuration 8 of digital input	-	0x000~0x11E	0x002	PSTF
P3.08 <sup>1</sup>	Configuration 9 of digital input	-	0x000~0x11E	0x007	PSTF
P3.09 <sup>1</sup>	Configuration 10 of digital input	-	0x000~0x11E	0x008	PSTF
P3.10 <sup>1</sup>	Output configuration of digital value 1	-	0x000~0x110	0x001	PSTF
P3.11 <sup>1</sup>	Output configuration of digital	-	0x000~0x110	0x003	PSTF

Function code	Name	Unit	Range	Default	Mode
	value 2				
P3.12 <sup>1</sup>	Output configuration of digital value 3	-	0x000~0x110	0x007	PSTF
P3.13 <sup>1</sup>	Output configuration of digital value 4	-	0x000~0x110	0x00D	PSTF
P3.14 <sup>1</sup>	Output configuration of digital value 5	-	0x000~0x110	0x005	PSTF
P3.15 <sup>1</sup>	Output configuration of digital value 6	-	0x000~0x110	0x00E	PSTF
P3.20	Offset of analog speed command	V	-10.000~10.000	0.000	S
P3.21	Filter of analog speed command	ms	0.0~1000.0	0.0	S
P3.22	Voltage protection of analog speed command	V	0.000~10.000	0.000	S
P3.23	Offset of analog torque command	V	-10.000~10.000	0.000	PSTF
P3.24	Filter of analog torque command	ms	0.0~1000.0	0.0	PSTF
P3.25	Voltage protection of analog torque command	V	0.000~10.000	0.000	PSTF
P3.30 <sup>1</sup>	AO 1 selection	-	0~19	0	PSTF
P3.31	AO 2 selection	-	0~214748364	0	PSTF
P3.32 <sup>1</sup>	Voltage gain of AO 1	-	0~19	0	PSTF
P3.33	Voltage gain of AO 2	-	0~214748364	0	PSTF
P3.34	Offset voltage of AO1	V	-10.000~10.000	0.000	PSTF
P3.35	Offset voltage of AO2	V	-10.000~10.000	0.000	PSTF
P3.36 <sup>1</sup>	Analog output monitor setting	-	0~2	0	PSTF
P3.40 <sup>1</sup>	Travel limit switch shield	-	0~2	1	PSTF
P3.41 <sup>1</sup>	E-stop shield	-	0~1	1	PSTF
P3.43 <sup>1</sup>	Digital input filter	0.125ms	1~8	1	PSTF
P3.44	Command pulse input invalid	-	0~1	0	PF

Function code	Name	Unit	Range	Default	Mode
	setting disabled				
P3.45 <sup>1</sup>	Clear mode of retention pulse	-	0~1	1	PF
P3.50	Range of position reaching	pulse	0~262144	100	PF
P3.51	Output mode of position reaching	-	0~3	0	PF
P3.52	Retention time of position reaching output terminal	ms	0~30000	0	PF
P3.53	Speed matching range	r/min	10~20000	50	PSTF
P3.54	Speed reaching range	r/min	10~20000	1000	PSTF
P3.55	Zero speed range	r/min	10~20000	50	PSTF
P3.56	Locked time of servo after braking	ms	0~1000	50	PSTF
P3.57	Braking delay time of the electromagnetic brake	ms	0~30000	500	PSTF
P3.58 <sup>1</sup>	Motor speed when brake clear	r/min	0~1000	30	PSTF
P3.59	Torque arriving range	%	5.0~300.0	50.0	T
P3.70 <sup>1</sup>	Pulse input filter	-	0~3	2	PSTF
P3.71	Analog input 3 zero drift	V	-10.000~10.000	0.000	PSTF
P3.72	Analog input 3 dead zone	V	0.000~3.000	0.000	PSTF
P3.73	Analog input 3 gain	-	0~2000	300	PSTF
P3.74	Analog input 3 reverse	-	0~1	0	PSTF
P3.75	Analog input 3 voltage protection	V	0.000~10.000	0.000	PSTF
P3.76	Analog input 3 filter	ms	0.0~1000.0	0.0	PSTF
P3.90	Pulse input filter	-	0~5	2	PSTF
<b>P4 Extension and application</b>					
P4.01 <sup>1</sup>	485 local communication address	-	1~255	1	PSTF
P4.02 <sup>1</sup>	CAN communication baud rate	-	0~5	1	PSTF
P4.03 <sup>1</sup>	485 communication baud rate	-	0~3	1	PSTF
P4.04 <sup>1</sup>	485 communication parity	-	0~5	0	PSTF

Function code	Name	Unit	Range	Default	Mode
	mode				
P4.05 <sup>1</sup>	CAN communication node	-	1~127	1	PSTF
P4.06	485 communication fault clear mode	-	0~1	1	PSTF
P4.07 <sup>1</sup>	EtherCAT synchronous cycle	-	0~3	2	PSTF
P4.08 <sup>1</sup>	EtherCAT synchronous type	-	0~2	0	PSTF
P4.09 <sup>1</sup>	EtherCAT fault detection time	ms	0~10000	100	PSTF
P4.10 <sup>1</sup>	Upper PC	-	0~1	0	PSTF
P4.11*	Bus servo enabling	-	0~1	0	PSTF
P4.12*	Bus position command	pulse	$-(2^{31}-1)\sim(2^{31}-1)$	0	PF
P4.13*	Bus speed command	r/min	-20000~20000	0	S
P4.14*	Bus torque command	%	-500.0~500.0	0.0	T
P4.15*	Switching command of control mode	-	0~1	0	PSTF
P4.16*	Gain switching command	-	0~1	0	PSTF
P4.17*	Switching command of electronic gear ratio	-	0~3	0	PF
P4.18*	Inertia ratio switch command	-	0~1	0	PSTF
P4.19*	Zero speed clamp command	-	0~1	0	ST
P4.20*	Retention pulse clear	-	0~1	0	PF
P4.21*	Torque switching command	-	0~1	0	PSTF
P4.22*	External fault command	-	0~1	0	PSTF
P4.23*	E-stop command	-	0~1	0	PSTF
P4.24*	Switch input command of vibration control	-	0~1	0	PF
P4.30	Stop mode	-	0~1	0	PSTF
P4.31	Max speed limit	r/min	0~20000	5000	PSTF
P4.32	Overspeed level	r/min	0~20000	6000	PSTF
P4.33	Pulse range for over-position	pulse	0~134217748	100000	PF
P4.34 <sup>1</sup>	Brake overload detection	-	0~2	0	PSTF
P4.36 <sup>1</sup>	Undervoltage protection of the main power supply	-	0~1	1	PSTF

Function code	Name	Unit	Range	Default	Mode
P4.37	Undervoltage detection time of the main power supply	ms	70~2000	70	PSTF
P4.38	Motor overload ratio	%	0~500.0	115.0	PSTF
P4.39	Speed tolerance	r/min	0~20000	0	PSF
P4.40	Forward speed limit	r/min	0~20000	20000	PSTF
P4.41	Reverse speed limit	r/min	-20000~0	-20000	PSTF
P4.50 <sup>1</sup>	Offset of encoder Z phase	pulse	0~1048575	0	PSTF
P4.51	Switching time 1 of the torque limit	ms/100 %	0~4000	0	PSF
P4.52	Switching time 2 of the torque limit	ms/100 %	0~4000	0	PSF
P4.53	Current loop response inching	%	50.0~100.0	100.0	PSTF
P4.54 <sup>1</sup>	Initialization time after power on	ms	0~10000	0	PSTF
P4.60 <sup>1</sup>	Frequency division molecular of external grating ruler	-	0~1048576	0	F
P4.61 <sup>1</sup>	Frequency division denominator of external grating ruler	-	1~1048576	10000	F
P4.62 <sup>1</sup>	Direction reverse of external grating ruler	-	0~1	0	F
P4.63 <sup>1</sup>	Invalid Z phase offline detection of external grating ruler	-	0~1	0	F
P4.64 <sup>1</sup>	Large mixed deviation setting	pulse	0~134217728	160000	F
P4.65 <sup>1</sup>	Mixed deviation clearing	r	0~100	0	F
P4.66 <sup>1</sup>	Z phase setting of external grating ruler	us	0~400	0	F
P4.67 <sup>1</sup>	External grating pulse output of AB phase	-	0~1	0	F
P4.68 <sup>1</sup>	External grating ruler (2 <sup>nd</sup> encoder) resolution	pulse	1~1048576	10000	PF
P4.69 <sup>1</sup>	Frequency division output source	-	0~3	0	PSTF

Function code	Name	Unit	Range	Default	Mode
P4.78 <sup>1</sup>	MotionNet node number	-	0~63	0	PSTF
P4.79 <sup>1</sup>	MotionNet baud rate	-	0~3	2	PSTF
P4.80	PZD setting parameter 1 configuration	-	1000~2398	1998	PSTF
P4.81	PZD setting parameter 2 configuration	-	1000~2398	1998	PSTF
P4.82	PZD setting parameter 3 configuration	-	1000~2398	1998	PSTF
P4.83	PZD feedback parameter 1 configuration	-	4000~5852	4012	PSTF
P4.84	PZD feedback parameter 2 configuration	-	4000~5852	4018	PSTF
P4.85	PZD feedback parameter 3 configuration	-	4000~5852	4032	PSTF
P4.86 <sup>1</sup>	PPO type of DP communication	-	5	5	PSTF
P4.87	CANopen communication cycle	us	0~(2 <sup>31</sup> -1)	0	PSTF
P4.88	CANopen heartbeat cycle	ms	0~32767	1000	PSTF
P4.90*	Fault restore	-	0~1	0	PSTF
P4.91*	Parameters saving	-	0~1	0	PSTF
P4.92*	Restore to the factory value	-	0~1	0	PSTF
P4.93*	Read enabled of the fault record	-	0~1	0	PSTF
P4.94*	Clear enabling of fault record	-	0~1	0	PSTF
P4.95*	Group number of fault record	-	0~9	0	PSTF
P4.96*	Initial angle encoder test	-	0~1	0	PSTF
P4.97*	EEPROM operation	-	0~1	0	PSTF
P4.98*	EEPROM data fault block	-	0~1	0	PSTF
<b>P5 Point control and returning (PTP)</b>					
P5.00	JOG mode	-	0~6	0	P
P5.01	JOG movement amount	pulse	1~2 <sup>30</sup>	50000	P

Function code	Name	Unit	Range	Default	Mode
P5.02	JOG speed setting	r/min	1~5000	500	P
P5.03	JOG ACC/DEC time	ms	2~10000	100	P
P5.04	JOG waiting time	ms	0~10000	100	P
P5.05	JOG cycle times	-	0~10000	1	P
P5.10 <sup>2</sup>	Returning mode	-	0~128	0	P
P5.11 <sup>1</sup>	To the origin automatically after power on	-	0~1	0	P
P5.12	High speed of the first step	r/min	0~2000	100	P
P5.13	High speed of the second step	r/min	0~60	20	P
P5.14	Origin setting	pulse	$-(2^{31}-1)\sim(2^{31}-1)$	0	P
P5.15*	Trigger command	-	0~1	0	P
P5.20*	Step trigger command	-	-1~100	-1	P
P5.21	00 target speed	r/min	0~6000	20	P
P5.22	01 target speed	r/min	0~6000	50	P
P5.23	02 target speed	r/min	0~6000	100	P
P5.24	03 target speed	r/min	0~6000	200	P
P5.25	04 target speed	r/min	0~6000	300	P
P5.26	05 target speed	r/min	0~6000	500	P
P5.27	06 target speed	r/min	0~6000	600	P
P5.28	07 target speed	r/min	0~6000	800	P
P5.29	08 target speed	r/min	0~6000	1000	P
P5.30	09 target speed	r/min	0~6000	1300	P
P5.31	10 target speed	r/min	0~6000	1500	P
P5.32	11 target speed	r/min	0~6000	1800	P
P5.33	12 target speed	r/min	0~6000	2000	P
P5.34	13 target speed	r/min	0~6000	2300	P
P5.35	14 target speed	r/min	0~6000	2500	P
P5.36	15 target speed	r/min	0~6000	3000	P
P5.37	00 ACC/DEC time	ms	0~32767	200	P
P5.38	01 ACC/DEC time	ms	0~32767	300	P
P5.39	02 ACC/DEC time	ms	0~32767	500	P
P5.40	03 ACC/DEC time	ms	0~32767	600	P



Function code	Name	Unit	Range	Default	Mode
P5.41	04 ACC/DEC time	ms	0~32767	800	P
P5.42	05 ACC/DEC time	ms	0~32767	900	P
P5.43	06 ACC/DEC time	ms	0~32767	1000	P
P5.44	07 ACC/DEC time	ms	0~32767	1200	P
P5.45	08 ACC/DEC time	ms	0~32767	1500	P
P5.46	09 ACC/DEC time	ms	0~32767	2000	P
P5.47	10 ACC/DEC time	ms	0~32767	2500	P
P5.48	11 ACC/DEC time	ms	0~32767	3000	P
P5.49	12 ACC/DEC time	ms	0~32767	5000	P
P5.50	13 ACC/DEC time	ms	0~32767	8000	P
P5.51	14 ACC/DEC time	ms	0~32767	50	P
P5.52	15 ACC/DEC time	ms	0~32767	30	P
P5.53	00 delay time	ms	0~32767	0	P
P5.54	01 delay time	ms	0~32767	100	P
P5.55	02 delay time	ms	0~32767	200	P
P5.56	03 delay time	ms	0~32767	400	P
P5.57	04 delay time	ms	0~32767	500	P
P5.58	05 delay time	ms	0~32767	800	P
P5.59	06 delay time	ms	0~32767	1000	P
P5.60	07 delay time	ms	0~32767	1500	P
P5.61	08 delay time	ms	0~32767	2000	P
P5.62	09 delay time	ms	0~32767	2500	P
P5.63	10 delay time	ms	0~32767	3000	P
P5.64	11 delay time	ms	0~32767	3500	P
P5.65	12 delay time	ms	0~32767	4000	P
P5.66	13 delay time	ms	0~32767	4500	P
P5.67	14 delay time	ms	0~32767	5000	P
P5.68	15 delay time	ms	0~32767	5500	P
<b>P6 Point control(PTP)</b>					
P6.00	00 control word	-	0~0x7FFFFFFF	0x00	P
P6.01	00 position	pulse	$-(2^{31}-1)\sim(2^{31}-1)$	0	P
P6.02	01 control word	-	0~0x7FFFFFFF	0x00	P

Function code	Name	Unit	Range	Default	Mode
P6.03	01 position	pulse	$-(2^{31}-1)\sim(2^{31}-1)$	0	P
P6.04	02 control word	-	0~0x7FFFFFFF	0x00	P
P6.05	02 position	pulse	$-(2^{31}-1)\sim(2^{31}-1)$	0	P
P6.06	03 control word	-	0~0x7FFFFFFF	0x00	P
P6.07	03 position	pulse	$-(2^{31}-1)\sim(2^{31}-1)$	0	P
P6.08	04 control word	-	0~0x7FFFFFFF	0x00	P
P6.09	04 position	pulse	$-(2^{31}-1)\sim(2^{31}-1)$	0	P
P6.10	05 control word	-	0~0x7FFFFFFF	0x00	P
P6.11	05 position	pulse	$-(2^{31}-1)\sim(2^{31}-1)$	0	P
P6.12	06 control word	-	0~0x7FFFFFFF	0x00	P
P6.13	06 position	pulse	$-(2^{31}-1)\sim(2^{31}-1)$	0	P
P6.14	07 control word	-	0~0x7FFFFFFF	0x00	P
P6.15	07 position	pulse	$-(2^{31}-1)\sim(2^{31}-1)$	0	P
P6.16	08 control word	-	0~0x7FFFFFFF	0x00	P
P6.17	08 position	pulse	$-(2^{31}-1)\sim(2^{31}-1)$	0	P
P6.18	09 control word	-	0~0x7FFFFFFF	0x00	P
P6.19	09 position	pulse	$-(2^{31}-1)\sim(2^{31}-1)$	0	P
P6.20	10 control word	-	0~0x7FFFFFFF	0x00	P
P6.21	10 position	pulse	$-(2^{31}-1)\sim(2^{31}-1)$	0	P
P6.22	11 control word	-	0~0x7FFFFFFF	0x00	P
P6.23	11 position	pulse	$-(2^{31}-1)\sim(2^{31}-1)$	0	P
P6.24	12 control word	-	0~0x7FFFFFFF	0x00	P
P6.25	12 position	pulse	$-(2^{31}-1)\sim(2^{31}-1)$	0	P
P6.26	13 control word	-	0~0x7FFFFFFF	0x00	P
P6.27	13 position	pulse	$-(2^{31}-1)\sim(2^{31}-1)$	0	P
P6.28	14 control word	-	0~0x7FFFFFFF	0x00	P
P6.29	14 position	pulse	$-(2^{31}-1)\sim(2^{31}-1)$	0	P
P6.30	15 control word	-	0~0x7FFFFFFF	0x00	P
P6.31	15 position	pulse	$-(2^{31}-1)\sim(2^{31}-1)$	0	P
<b>P8 P9 P10 Factory parameters</b>					
-	Factory parameters	-	-	-	-

## 10.2 State monitoring



Function code	Name	Unit	Range	Default	Mode
<b>R0 User monitoring parameters</b>					
R0.00	Motor speed	r/min	-20000~20000	0	PSTF
R0.01	Speed command	r/min	-20000~20000	0	PSTF
R0.02	Feedback pulse accumulation	pulse	$-(2^{63}-1)\sim(2^{63}-1)$	0	PF
R0.03	Command pulse accumulation	pulse	$-(2^{63}-1)\sim(2^{63}-1)$	0	PF
R0.04	Retention pulse	pulse	$-(2^{63}-1)\sim(2^{31}-1)$	0	PF
R0.05	Hybrid control deviation	pulse	$-(2^{63}-1)\sim(2^{31}-1)$	0	F
R0.06	Current torque	%	-500.0~500.0	0	PSTF
R0.07	DC voltage of main circuit	V	0.0~1000.0	0	PSTF
R0.08	DC voltage of control circuit	V	0.0~1000.0	0	PSTF
R0.09	Output voltage	Vrms	0.0~1000.0	0	PSTF
R0.10	Output current	Arms	0.0~1000.0	0	PSTF
R0.11	Drive temperature	℃	-55.0~180.0	0	PSTF
R0.12	Torque limit	%	-500.0~500.0	0	PSTF
R0.13	Encoder feedback	pulse	0~1048575	0	PSTF
R0.14	Position relative to Z pulse	pulse	0~1048575	0	PSTF
R0.15	Inertia ratio of load	%	0~10000	0	PSTF
R0.16	Output power	%	-500.0~500.0	0	PSTF
R0.17	Motor load ratio	%	0~500	0	PSTF
R0.18	Molecule of actual electric gear ratio	-	$0\sim(2^{31}-1)$	0	PF
R0.19	Denominator of actual electric gear ratio	-	$1\sim(2^{31}-1)$	0	PF
R0.20	Position command speed	r/min	-20000~20000	0	PF
R0.21	Instant speed	r/min	-20000~20000	0	PSTF
R0.22	Bit state	-	-1~215	0	P
R0.23	Absolute position of encoder feedback	pulse	$-(2^{31}-1)\sim(2^{31}-1)$	0	PSTF
R0.24	EEPROM data state	-	0~3	0	PSTF
R0.25	Circles of multi-circle encoder	-	-32768~32767	0	PSTF
R0.26	Available encoder type	-	0~6	0	PSTF

Function code	Name	Unit	Range	Default	Mode
R0.27	EtherCAT clock synchronous correction state	-	0~1	0	PSTF
R0.28	State of CANopen state machine	-	0~18	0	PSTF
R0.29	Node of PROFIBUS-DP slave station	-	0~99	0	PSTF
R0.30	System state	-	0~5	0	PSTF
R0.31	IGBT state	-	0~1	0	PSTF
R0.32	Current mode	-	0~7	0	PSTF
R0.33	Power on time	s	0~(2 <sup>31</sup> -1)	0	PSTF
R0.34	Operation time	s	0~(2 <sup>31</sup> -1)	0	PSTF
R0.35	DSP software version	-	0.00~10.00	2.00	PSTF
R0.36	FPGA software version	-	0.00~10.00	2.00	PSTF
R0.37	Communication card software version	-	0.00~10.00	2.00	PSTF
R0.38	Drive serial No.1	-	0~65535	0	PSTF
R0.39	Drive serial No.2	-	0~65535	0	PSTF
R0.40	Drive serial No.3	-	0~65535	0	PSTF
R0.41	Drive serial No.4	-	0~65535	0	PSTF
R0.42	Drive serial No.5	-	0~65535	0	PSTF
R0.43	Drive serial No.6	-	0~65535	0	PSTF
R0.44	Absolute position of grating ruler (2 <sup>nd</sup> encoder) in single circle	pulse	0~1048575	0	PSTF
<b>R1 IO monitoring parameters</b>					
R1.00	Digital input state	-	0x000~0x3FF	0x000	PSTF
R1.01	Digital output state	-	0x00~0x3F	0x00	PSTF
R1.02	Original sample of the analog speed command	-	0~65535	32768	S
R1.03	Original sample of the analog torque command	-	0~65535	32768	ST
R1.04	Original sample of analog input 3	-	0~65535	32768	PSTF

Function code	Name	Unit	Range	Default	Mode
R1.05	Voltage of the analog speed command	V	-10.000~10.000	0.000	S
R1.06	Voltage of the analog torque command	V	-10.000~10.000	0.000	ST
R1.07	Voltage of analog input 3	V	-10.000~10.000	0.000	PSTF
R1.08	Voltage of analog output 1	V	-10.000~10.000	0.000	PSTF
R1.09	Voltage of analog output 2	V	-10.000~10.000	0.000	PSTF
R1.10	Voltage of analog output	V	-10.000~10.000	0.000	PSTF
R1.11	Cumulative value of input pulses	pulse	$-(2^{31}-1)\sim(2^{31}-1)$	0	PF
R1.12	Pulse position command	pulse	$-(2^{31}-1)\sim(2^{31}-1)$	0	PF
<b>R2 Factory monitoring parameters</b>					
-	-	-	-	-	-
<b>R3 Fault records</b>					
R3.00	Fault code record	-	-	-	PSTF
R3.01	Power on time when fault occurs	s	$0\sim(2^{31}-1)$	0	PSTF
R3.02	Operation time when fault occurs	s	$0\sim(2^{31}-1)$	0	PSTF
R3.03	Motor speed when fault occurs	r/min	-20000~20000	0	PSTF
R3.04	Speed command when fault occurs	r/min	-20000~20000	0	PSTF
R3.05	Feedback pulse accumulation when fault occurs	pulse	$-(2^{63}-1)\sim(2^{63}-1)$	0	PF
R3.06	Command pulse accumulation when fault occurs	pulse	$-(2^{63}-1)\sim(2^{63}-1)$	0	PF
R3.07	Stranded pulse when fault occurs	pulse	$-(2^{31}-1)\sim(2^{31}-1)$	0	PF
R3.08	Current torque when fault occurs	%	-500.0~500.0	0.0	PSTF
R3.09	Main circuit dc voltage when fault occurs	V	0.0~1000.0	0.0	PSTF

Function code	Name	Unit	Range	Default	Mode
R3.10	Output voltage at fault	Vrms	0.0~1000.0	0.0	PSTF
R3.11	Output current at fault	Arms	0.0~1000.0	0.00	PSTF
R3.20	Latest fault record	-	-	-	PSTF
R3.21	Latest 2 fault record	-	-	-	PSTF
R3.22	Latest 3 fault record	-	-	-	PSTF
R3.23	Latest 4 fault record	-	-	-	PSTF
R3.24	Latest 5 fault record	-	-	-	PSTF
R3.25	Latest 6 fault record	-	-	-	PSTF
R3.26	Latest 7 fault record	-	-	-	PSTF
R3.27	Latest 8 fault record	-	-	-	PSTF
R3.28	Latest 9 fault record	-	-	-	PSTF
R3.29	Latest 10 fault record	-	-	-	PSTF

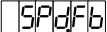
### 10.3 General monitoring parameters

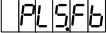
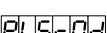
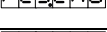
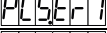
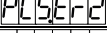
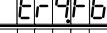
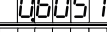
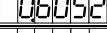
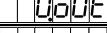
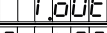
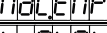
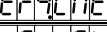
Setting value of P0.15	Meaning	Sign	Unit	Corresponding parameter
<b>[0]</b>	Motor rotation speed		r/min	R0.00
1	Speed command		r/min	R0.01
2	Pulse feedback accumulation		pulse	R0.02
3	Pulse command accumulation		pulse	R0.03
4	Stranded pulse		pulse	R0.04
5	Hybrid control deviation		pulse	R0.05
6	Current torque		%	R0.06
7	Main circuit DC voltage		V	R0.07
8	Control power supply voltage		V	R0.08
9	Output voltage		Vrms	R0.09
10	Output current		Arms	R0.10
11	Drive temperature		°C	R0.11
12	Torque limit		%	R0.12
13	Encoder feedback		pulse	R0.13

Setting value of P0.15	Meaning	Sign	Unit	Corresponding parameter
14	Rotor position to Z pulse	EncAbs	pulse	R0.14
15	Load inertia ratio	J-r	%	R0.15
16	Output power	PoEr	%	R0.16
17	Motor load rate	LoAd-r	%	R0.17
18	Molecule of actual electronic gear	nUN	-	R0.18
19	Denominator of actual electronic gear	dEn	-	R0.19
20	Pulse speed command	PLSPd	r/min	R0.20
21	Instant speed	SPdFbi	r/min	R0.21
22	Bit state	PtPStS	-	R0.22

## 10.4 Fault code

The format of fault code is ErXX-X, of which, XX is the master code and X is the sub code.

**Example:** Er01-0, the master code is 01, the sub code is 0.

Fault code	Name	Feature		
		History record	Can be cleared	Stop instantly
Er01-0	IGBT fault	•		•
Er02-0	Encoder fault–The encoder wire break	•		•
Er02-1	Encoder fault–Encoder feedback error is too large	•		•
Er02-2	Encoder fault–Parity error	•		•
Er02-3	Encoder fault–CRC error	•		•
Er02-4	Encoder fault–Frame error	•		•
Er02-5	Encoder fault–A short frame error	•		•
Er02-6	Encoder fault–Encoder overtime	•		•
Er02-7	Encoder fault–FPGA overtime	•		•
Er02-8	Encoder fault–Low voltage alarm of the encoder	•		•
Er02-9	Encoder fault–Undervoltage alarm of the encoder	•		•

Fault code	Name	Feature		
		History record	Can be cleared	Stop instantly
Er02-a	Encoder fault–Encoder temperature	•		•
Er02-b	Encoder fault–EEPROM error	•		•
Er02-c	Encoder fault–EEPROM no data			•
Er02-d	Encoder fault–EEPROM polarity error			•
Er03-0	Current sensor fault–U IGBT fault	•		•
Er03-1	Current sensor fault–V IGBT fault	•		•
Er03-2	Current sensor fault–W IGBT fault	•		•
Er04-0	System initialization fault	•		•
Er05-1	Setting fault–Motor model error	•		•
Er05-2	Setting fault–Motor and drive model error	•		•
Er05-3	Setting fault–Software limit setting error	•	•	•
Er05-4	Setting fault–Back to the origin of fault settings	•	•	•
Er05-5	Setting fault–Position control overflow fault	•	•	•
Er07-0	Regeneration of discharge overload fault	•	•	•
Er08-0	Analog input overvoltage fault–Analog speed command	•	•	•
Er08-1	Analog input overvoltage fault–Analog torque command	•	•	•
Er08-2	Analog input overvoltage fault–Analog input 3	•	•	•
Er09-0	EEPROM fault–Read-write fault			•
Er09-1	EEPROM fault–data verification fault			•
Er10-0	Hardware fault–FPGA fault	•		•
Er10-1	Hardware fault–Communication card fault	•	•	•
Er10-2	Hardware fault–Ground short circuit fault	•		•
Er10-3	Hardware fault–External input fault	•	•	•
Er10-4	Hardware fault–E-stop fault	•	•	•
Er10-5	Hardware fault–485 communication fault	•	•	•
Er11-1	Software fault–Reentrant cycle mission	•		•
Er11-2	Software fault–Illegal operation	•		•
Er12-0	IO fault–Repeat switch input and distribution	•	•	•
Er12-2	IO fault–Pulse input frequency is too high	•	•	•



Fault code	Name	Feature		
		History record	Can be cleared	Stop instantly
Er13-0	Main circuit overvoltage fault	•	•	•
Er13-1	Main circuit undervoltage fault		•	•
Er14-0	Undervoltage control power supply fault		•	•
Er18-0	Motor overload fault	•	•	•
Er19-0	Speed fault–Overspeed fault	•	•	•
Er20-0	Speed deviation fault	•	•	•
Er22-0	Deviation fault–Position deviation	•	•	•
Er22-1	Deviation fault–Hybrid control deviation is too large	•	•	•
Er22-2	Position increment over fault	•	•	•
Er22-3	CANopen fault–Sync signal timeout	•	•	•
Er23-0	The drive thermal fault	•	•	•
Er24-0	PROFIBUS-DP fault–PWK parameters ID error		•	
Er24-1	PROFIBUS-DP fault–PWK Parameters beyond the range		•	
Er24-2	PROFIBUS-DP fault–PWK Parameters are read-on		•	
Er24-3	PROFIBUS-DP fault–PZD Configuration parameter does not exist		•	
Er24-4	PROFIBUS-DP fault–PZD Configuration parameter properties do not match		•	
Er25-4	Application fault– encoder offset angle test overtime	•		•
Er25-5	Application fault– encoder offset angle test failure	•		•
Er25-6	Application fault–Offside of back to the origin	•		•
Er25-7	Application fault–Moment of inertia identification failure	•	•	•
Er26-0	CANopen fault–SDO overtime		•	
Er26-1	CANopen fault–SDO index does not exist		•	
Er26-2	CANopen fault–SDO sub index does not exist		•	

Fault code	Name	Feature		
		History record	Can be cleared	Stop instantly
Er26-3	CANopen fault–SDO block length error		•	
Er26-4	CANopen fault–SDO beyond the scope of written data		•	
Er26-5	CANopen fault–Read-only		•	
Er26-6	CANopen fault–PDO mapping length error		•	
Er26-7	CANopen fault–PDO mapping data does not exist		•	
Er26-8	CANopen fault–PDO is not allowed to be changed during operating		•	
Er26-9	CANopen fault–PDO mapping is not allowed		•	
Er26-a	CANopen fault–Sync signal is too fast		•	
Er26-b	CANopen fault–Receive fault		•	
Er26-c	CANopen fault–Send failure		•	
Er26-d	CANopen fault–Sync signal repeat		•	
Er26-e	CANopen fault–The bus load rate is too high		•	
Er26-f	CANopen fault–Parameter state changes error		•	





Service line: 400-700-9997 ; +86-21-34637660 Website: [www.invt-tech.com](http://www.invt-tech.com)

---

INVT INDUSTRIAL TECHNOLOGY (SHANGHAI) CO.,LTD.

No. 1 Building, No. 188 New Junhuan Road, Pujiang High Tech Park, Minhang District, Shanghai

**Industrial Automation:** ■ Frequency Inverter ■ Servo & Motion Control ■ Motor & Electric Spindle ■ PLC

■ HMI ■ Intelligent Elevator Control System ■ Traction Drive

**Electric Power** ■ SVG ■ Solar Inverter ■ UPS ■ Online Energy Management System



66001-00351

INVT Copyright.

Information may be subject to change without notice during product improving.

201505 (V1.0)