



Operation **Manual**

Goodrive300 Series VFD



SHENZHEN INVT ELECTRIC CO., LTD.

Preface

Thanks for choosing our products.

Goodrive300 series variable-frequency drives (VFDs) are high-performance open loop vector VFDs for controlling asynchronous AC induction motors and permanent magnet synchronous motors. Applying the most advanced non-velocity sensor vector control technology which keeps pace with the leading international technology and DSP control system, our products enhance their reliability, environmental adaptability, and customized and industrialized design with more optimized functions, more flexible application and more stable performance.

The control performance of Goodrive300 series VFDs is as outstanding as that of the leading sophisticated VFDs on worldwide market. Goodrive300 series VFDs integrate the drive of asynchronous motors and synchronous motors, torque control and speed control, meeting the high performance requirement of the customer applications and stepping on the unique incorporated VFDs with superexcellent control functions in this circle. Simultaneously, comparing with the other kinds, Goodrive300 series VFDs can adapt to worse grid, temperature, humidity and dust with a better performance of anti-tripping and improved the reliability.

Goodrive300 series VFDs apply modularized design to meet the specific demand of customers, as well as the demand of the whole industry flexibly and follow the trend of industrial application to the VFDs on the premise of meeting general need of the market. Powerful speed control, torque control, simple PLC, flexible input/output terminals, pulse frequency given, traverse control can realize various complicate high-accuracy drives and provide integrative solution for the manufacturers of industrial devices, which contributes a lot to the cost reducing and improves reliability.

Goodrive300 series VFDs can meet the demand of environmental protection which focuses on low noise and weakening electromagnetic interference in the application sites for the customers.

This manual provides installation and configuration, parameters setting, fault diagnoses and daily maintenance and related precautions to customers. Please read this manual carefully before the installation to ensure a proper installation and operation and high performance of Goodrive300 series VFDs.

If the product is ultimately used for military affairs or manufacture of weapon, it will be listed on the export control formulated by ***Foreign Trade Law of the People's Republic of China***. Rigorous review and necessary export formalities are needed when exported.

Our company reserves the right to update the information of our products.

Contents

Preface	i
Contents	ii
Chapter 1 Safety precautions	1
1.1 What this chapter contains	1
1.2 Safety definition	1
1.3 Warning symbols	1
1.4 Safety guide	2
Chapter 2 Quick start-up	5
2.1 What this chapter contains	5
2.2 Unpacking inspection	5
2.3 Application confirmation	5
2.4 Environment	5
2.5 Installation confirmation	6
2.6 Basic commissioning	6
Chapter 3 Product overview	7
3.1 What this chapter contains	7
3.2 Basic principles	7
3.3 Product specification	9
3.4 Name plate	11
3.5 Model code	11
3.6 Rated specifications	12
3.7 Structure diagram	14
Chapter 4 Installation guide	16
4.1 What this chapter contains	16
4.2 Mechanical installation	16
4.3 Standard wiring	22
4.4 Layout protection	33
Chapter 5 Keypad operation procedure	34
5.1 What this chapter contains	34
5.2 Keypad	34
5.3 Keypad displaying	36
5.4 Keypad operation	38
Chapter 6 Function parameters	40
6.1 What this chapter contains	40
6.2 Goodrive300 general series function parameters	40
Chapter 7 Basic operation instruction	125
7.1 What this chapter contains	125
7.2 First powering on	125
7.3 Vector control	129

7.4 SVPWM control	133
7.5 Torque control	138
7.6 Parameters of the motor	141
7.7 Start-up and stop control	147
7.8 Frequency setting	152
7.9 Analog input	156
7.10 Analog output	158
7.11 Digital input	162
7.12 Digital output	169
7.13 Simple PLC	173
7.14 Multi-step speed running	175
7.15 PID control	177
7.16 Traverse running	182
7.17 Pulse counter	183
7.18 Fixed-length control	184
7.19 Fault procedure	185
Chapter 8 Fault tracking	189
8.1 What this chapter contains	189
8.2 Alarm and fault indications	189
8.3 How to reset	189
8.4 Fault history	189
8.5 Fault instruction and solution	189
8.6 Common fault analysis	195
Chapter 9 Maintenance and hardware diagnostics	202
9.1 What this chapter contains	202
9.2 Maintenance intervals	202
9.3 Cooling fan	204
9.4 Capacitors	205
9.5 Power cable	206
Chapter 10 Communication protocol	207
10.1 What this chapter contains	207
10.2 Brief introduction of Modbus protocol	207
10.3 Application of the VFD	207
10.4 RTU command code and communication data illustration	213
10.5 Common communication fault	228
Chapter A Extension card	229
A.1 What this chapter contains	229
A.2 PROFIBUS extension card	229
A.3 CANopen optional cards	245
Chapter B Technical data	246
B.1 What this chapter contains	246

B.2 Ratings	246
B.3 Grid specifications	247
B.4 Motor connection data	247
B.5 Applicable standards	248
B.6 EMC regulations	249
Chapter C Dimension drawings	251
C.1 What this chapter contains	251
C.2 Keypad structure	251
C.3 VFD structure	252
C.4 Dimensions for VFDs of AC 3PH 380V(-15%)–440V(+10%)	252
C.5 Dimensions for VFDs of AC 3PH 380V (-10%)–550V (+10%)	256
C.6 Dimensions for VFDs of AC 3PH 520V (-15%)–690V (+10%)	257
Chapter D Peripheral options and parts	261
D.1 What this chapter contains	261
D.2 Peripheral wiring	261
D.3 Power supply	262
D.4 Cables	263
D.5 Breaker and electromagnetic contactor	268
D.6 Reactors	271
D.7 Filter	274
D.8 Braking system	277
Chapter E Further information	283
E.1 Product and service queries	283
E.2 Feedback on INVT VFD manuals	283
E.3 Documents on the Internet	283

Chapter 1 Safety precautions

1.1 What this chapter contains

Please read this manual carefully and follow all safety precautions before moving, installing, operating and servicing the variable-frequency drive (VFD). If ignored, physical injury or death may occur, or damage may occur to the devices.









If any physical injury or death or damage to the devices occurs due to the ignorance of the safety precautions in the manual, our company will not be responsible for any damages and we are not legally bound in any manner.

1.2 Safety definition





Danger:	Serious physical injury or even death may occur if related requirements are not followed.
Warning:	Physical injury or damage to the devices may occur if related requirements are not followed.
Note:	Steps to take for ensuring the proper running of the VFD.
Qualified electricians:	People working on the device should take part in professional electrical and safety training, obtain the certification and be familiar with all steps and requirements of installing, commissioning, operating and maintaining the device to prevent emergencies.

1.3 Warning symbols

Warnings caution you about conditions which can result in serious injury or death and/or damage to the equipment, and advice on how to avoid the danger. The following table describes the warning symbols used in this manual.

Symbols	Name	Description	Abbreviation
 Danger	Electrical Danger	Serious physical injury or even death may occur if related requirements are not followed.	
 Warning	General danger	Physical injury or damage to the devices may occur if related requirements are not followed.	
 Electrostatic discharge	Electrostatic discharge	Damage to the PCBA board may occur if related requirements are not followed.	
 Hot sides	Hot sides	Sides of the device may become hot. Do not touch.	
Note	Note	Steps to take for ensuring the proper running of the VFD.	Note

1.4 Safety guide

	<ul style="list-style-type: none"> • Only qualified electricians are allowed to operate on the VFD. • Do not carry out any wiring and inspection or changing components when power is applied. Ensure all input power is disconnected before wiring and checking and always wait for at least the time designated on the VFD or until the DC bus voltage is less than 36V. The following table describes the the waiting time. 																											
	<table border="1" style="width: 100%; border-collapse: collapse;"> <thead> <tr> <th colspan="2" style="text-align: center;">VFD model</th> <th style="text-align: center;">Minimum waiting time</th> </tr> </thead> <tbody> <tr> <td style="text-align: center;">380V</td> <td style="text-align: center;">1.5kW–110kW</td> <td style="text-align: center;">5 minutes</td> </tr> <tr> <td style="text-align: center;">380V</td> <td style="text-align: center;">132kW–315kW</td> <td style="text-align: center;">15 minutes</td> </tr> <tr> <td style="text-align: center;">380V</td> <td style="text-align: center;">above 350kW</td> <td style="text-align: center;">25 minutes</td> </tr> <tr> <td style="text-align: center;">500V</td> <td style="text-align: center;">4kW–18.5kW</td> <td style="text-align: center;">5 minutes</td> </tr> <tr> <td style="text-align: center;">500V</td> <td style="text-align: center;">22kW–75kW</td> <td style="text-align: center;">15 minutes</td> </tr> <tr> <td style="text-align: center;">660V</td> <td style="text-align: center;">22kW–132kW</td> <td style="text-align: center;">5 minutes</td> </tr> <tr> <td style="text-align: center;">660V</td> <td style="text-align: center;">160kW–350kW</td> <td style="text-align: center;">15 minutes</td> </tr> <tr> <td style="text-align: center;">660V</td> <td style="text-align: center;">400kW–630kW</td> <td style="text-align: center;">25 minutes</td> </tr> </tbody> </table>	VFD model		Minimum waiting time	380V	1.5kW–110kW	5 minutes	380V	132kW–315kW	15 minutes	380V	above 350kW	25 minutes	500V	4kW–18.5kW	5 minutes	500V	22kW–75kW	15 minutes	660V	22kW–132kW	5 minutes	660V	160kW–350kW	15 minutes	660V	400kW–630kW	25 minutes
	VFD model		Minimum waiting time																									
	380V	1.5kW–110kW	5 minutes																									
	380V	132kW–315kW	15 minutes																									
	380V	above 350kW	25 minutes																									
	500V	4kW–18.5kW	5 minutes																									
	500V	22kW–75kW	15 minutes																									
	660V	22kW–132kW	5 minutes																									
660V	160kW–350kW	15 minutes																										
660V	400kW–630kW	25 minutes																										
 <ul style="list-style-type: none"> • Do not refit the VFD unauthorizedly; otherwise fire, electric shock or other injury may occur. 																												
 <ul style="list-style-type: none"> • The base of the radiator may become hot during running. Do not touch, otherwise, physical injury may occur. 																												
 <ul style="list-style-type: none"> • The electrical parts and components inside the VFD are electrostatic. Take measurements to avoid electrostatic discharge during related operation. 																												

1.4.1 Delivery and installation

	<ul style="list-style-type: none"> • Please install the VFD on fire-retardant material and keep the VFD away from combustible materials. • Connect the optional braking parts (braking resistors, braking units or feedback units) according to the wiring diagram. • Do not operate on the VFD if there is any damage or components loss to the VFD. • Do not touch the VFD with wet items or body, otherwise electric shock may occur.
---	--

Note:

- Select appropriate moving and installing tools to ensure a safe and normal running of the VFD and avoid physical injury or death. For physical safety, the erector should take some mechanical protective measurements, such as wearing exposure shoes and working uniforms.
- Ensure to avoid physical shock or vibration during delivery and installation.

- Do not carry the VFD by its cover. The cover may fall off.
- Install away from children and other public places.
- The VFD cannot meet the requirements of low voltage protection in IEC61800-5-1 if the altitude of installation site is above 2000m.
- Please use the VFD on appropriate condition (See section 4.2.1 "Installation environment").
- Don't allow screws, cables and other conductive items to fall inside the VFD.
- The leakage current of the VFD may be above 3.5mA during operation. The leakage current is high, so performing grounding before supply connection is essential. Ground with proper techniques and ensure the grounding resistor is less than 10Ω. The conductivity of PE grounding conductor is the same as that of the phase conductor (with the same cross sectional area). For models higher than 30 kW, the cross sectional area of the PE grounding conductor can be slightly less than the recommended area.
- R, S and T are the input terminals of the power supply, while U, V and W are the motor output terminals. Please connect the input power cables and motor cables with proper techniques; otherwise damage to the VFD may occur.

1.4.2 Commission and running



- Disconnect all power supplies applied to the VFD before the terminal wiring and wait for at least the designated time after disconnecting the power supply.
- High voltage is present inside the VFD during running. Do not carry out any operation except for the keypad setting. It must be noted that the control terminals of the VFDs of 3PH AC 500V and 3PH AC 660V are ELV (Extra Low Voltage) circuit, which cannot be connected directly to the accessible terminals of other devices if no protective isolation measure is taken.
- The VFD may start up by itself when P01.21=1. Do not get close to the VFD and motor.
- The VFD cannot be used as "Emergency-stop device".
- The VFD cannot be used to break the motor suddenly. A mechanical braking device should be provided.
- Besides the above precautions, you must ensure the following before the installation and maintenance if a permanent-magnet synchronous motor is running:
 1. All input power is disconnected (including the main power supply and the control power supply).
 2. The permanent-magnet synchronous motor has stopped running and measured to ensure the output voltage of the VFD is less than 36V.
 3. The waiting time of the permanent-magnet synchronous motor after stopping is no less than the time designated and measure to ensure the voltage between + and – is less than 36V.

	<p>4. Ensure the permanent-magnet synchronous motor does not rotate again because of the external load. It is recommended to install effectively external braking devices or disconnect the electric wiring between the motor and the VFD directly.</p>
--	---

Note:

- Do not switch on or off the input power supply of the VFD frequently.
- For VFDs that have been stored for a long time, check and fix the capacitance and try to run it again before utilization (see Chapter 9 "Maintenance and hardware fault diagnostics").
- Cover the front board before running, otherwise electric shock may occur.



1.4.3 Maintenance and replacement of components

	<ul style="list-style-type: none"> • Only qualified electricians are allowed to perform the maintenance, inspection, and components replacement of the VFD. • Disconnect all power supplies to the VFD before the terminal wiring. Wait for at least the time designated on the VFD after disconnection. • Take measures to avoid screws, cables and other conductive matters to fall into the VFD during maintenance and component replacement.
---	---

Note:

- Please select proper torque to tighten screws.
- Keep the VFD, parts and components away from combustible materials during maintenance and component replacement.
- Do not carry out any isolation and pressure test on the VFD and do not measure the control circuit of the VFD by megameter.
- Carry out a sound anti-electrostatic protection to the VFD and its internal components during maintenance and component replacement.

1.4.4 What to do after scrapping

	<ul style="list-style-type: none"> • There are heavy metals in the VFD. Deal with it as industrial effluent.
	<ul style="list-style-type: none"> • When the life cycle ends, the product should enter the recycling system. Dispose of it separately at an appropriate collection point instead of placing it in the normal waste stream.

Chapter 2 Quick start-up

2.1 What this chapter contains

This chapter mainly describes the basic guidelines for the installation and commission procedures on the VFD, which you may follow to install and commission the VFD quickly.

2.2 Unpacking inspection

Check as follows after receiving products:

- | |
|---|
| 1. Check whether the packing box is damaged or dampened. If yes, contact local dealers or company offices. |
| 2. Check the model identifier on the exterior surface of the packing box is consistent with the purchased model. If no, contact local dealers or company offices. |
| 3. Check whether the interior surface of packing box is abnormal, for example, in wet condition, or whether the enclosure of the VFD is damaged or cracked. If yes, contact local dealers or company offices. |
| 4. Check whether the name plate of the VFD is consistent with the model identifier on the exterior surface of the packing box. If no, contact local dealers or company offices. |
| 5. Check whether the accessories (including the user manual, control keypad and extension card) inside the packing box are complete. If no, contact local dealers or company offices. |

2.3 Application confirmation

Check the machine before beginning to use the VFD:

- | |
|--|
| 1. Check the load type to verify that there is no overload of the VFD during work and check that whether the drive needs to modify the power degree. |
| 2. Check that the actual current of the motor is less than the rated current of the VFD. |
| 3. Check that the control accuracy of the load is the same of the VFD. |
| 4. Check that the incoming supply voltage is correspondent to the rated voltage of the VFD. |
| 5. Check that the communication needs option card or not. |

2.4 Environment

Check as followings before the actual installation and usage:

- | |
|---|
| 1. Check that the ambient temperature of the VFD is below 40°C. If temperature is above 40°C, derate 1% for every additional 1°C. Additionally, the VFD cannot be used if the ambient temperature is above 50°C.
Note: for the cabinet VFD, the ambient temperature means the air temperature inside the cabinet. |
| 2. Check that the ambient temperature of the VFD in actual usage is above -10°C. If not, add heating facilities.
Note: for the cabinet VFD, the ambient temperature means the air temperature inside the cabinet. |

- | |
|--|
| 3. Check that the altitude of the actual usage site is below 1000m. If exceeds, derate 1% for every additional 100m. |
| 4. Check that the humidity of the actual usage site is below 90% and condensation is not allowed. If not, add additional protection VFDs. |
| 5. Check that the actual usage site is away from direct sunlight and foreign objects cannot enter the VFD. If not, add additional protective measures. |
| 6. Check that there is no conductive dust or flammable gas in the actual usage site. If not, add additional protection to VFDs. |

2.5 Installation confirmation

Check as followings after the installation:

- | |
|---|
| 1. Check that the load range of the input and output cables meet the need of actual load. |
| 2. Check that the accessories of the VFD are correctly and properly installed. The installation cables should meet the needs of every component (including reactors, input filters, output reactors, output filters, DC reactors, braking units and braking resistors). |
| 3. Check that the VFD is installed on non-flammable materials and the calorific accessories (reactors and brake resistors) are away from flammable materials. |
| 4. Check that all control cables and power cables are run separately and the routation complies with EMC requirement. |
| 5. Check that all grounding systems are properly grounded according to the requirements of the VFD. |
| 6. Check that the free space during installation is sufficient according to the instructions in user's manual. |
| 7. Check that the installation conforms to the instructions in user's manual. The drive must be installed in an upright position. |
| 8. Check that the external connection terminals are tightly fastened and the torque is appropriate. |
| 9. Check that there are no screws, cables and other conductive items left in the VFD. If not, get them out. |

2.6 Basic commissioning

Complete the basic commissioning as follows before actual utilization:

- | |
|---|
| 1. Select the motor type, set correct motor parameters and select control mode of the VFD according to the actual motor parameters. |
| 2. Autotune. If possible, de-coupled from the motor load to start dynamic autotune. Or if no, static autotune is available. |
| 3. Adjust the ACC/DEC time according to the actual running of the load. |
| 4. Commission the device via jogging and check that the rotation direction is as required. If not, change the rotation direction by changing the wiring of motor. |
| 5. Set all control parameters and then operate. |

Chapter 3 Product overview

3.1 What this chapter contains

This chapter briefly describes the operation principle, product characteristics, layout, name plate and model information.

3.2 Basic principles

Goodrive300 series VFDs are wall, flange, and floor mountable devices for controlling asynchronous AC induction motors and permanent-magnet synchronous motors.

The diagram below shows the simplified main circuit diagram of the VFD. The rectifier converts three-phase AC voltage to DC voltage. The capacitor bank of the intermediate circuit stabilizes the DC voltage. The inverter transforms the DC voltage back to AC voltage for the AC motor. The brake pipe connects the external braking resistor to the intermediate DC circuit to consume the fed-back energy when the voltage in the circuit exceeds its maximum limit.

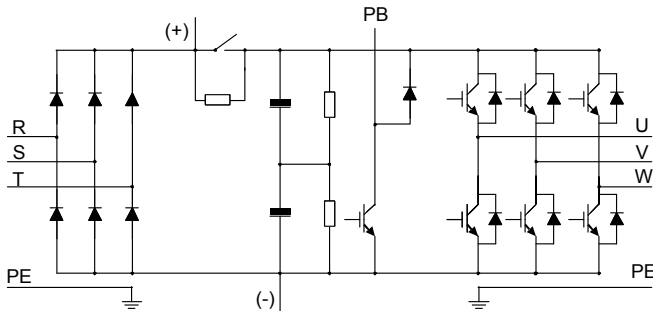

Figure 3-1 Main circuit of 380V VFDs (≤ 30kW)

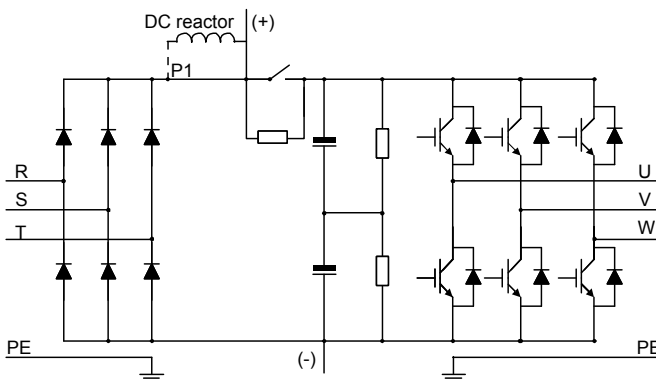

Figure 3-2 Main circuit of 380V VFDs (≥ 37kW)

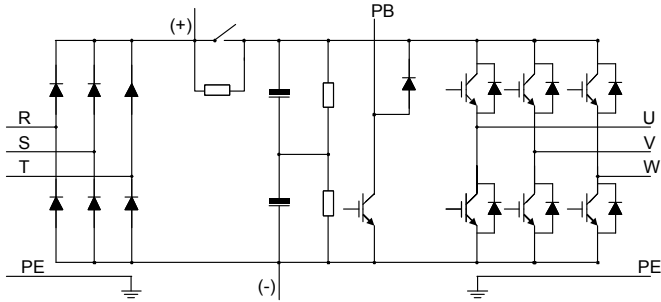

Figure 3-3 Main circuit of 500V VFDs ($\leq 18.5\text{kW}$)

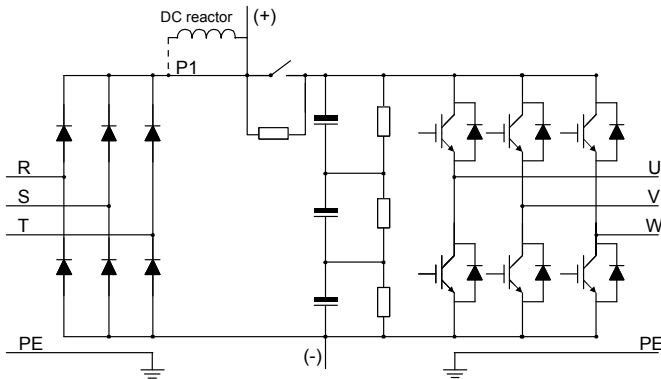

Figure 3-4 Main circuit of 500V VFDs ($\geq 22\text{kW}$)

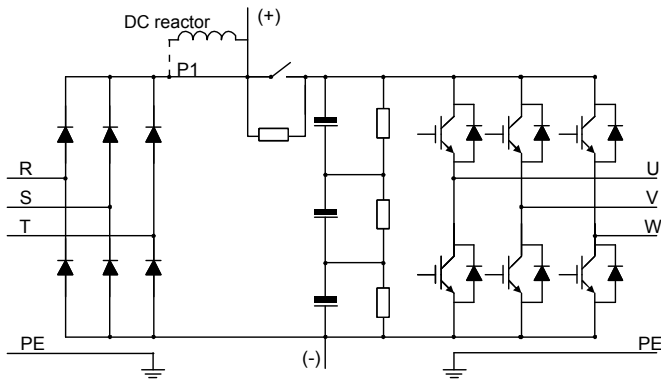

Figure 3-5 Main circuit of 660V VFDs

Note:

1. The VFDs of 380V ($\geq 37\text{kW}$) supports external DC reactors and external braking units, but it is

necessary to remove the copper tag between P1 and (+) before connecting. DC reactors and external braking units are optional.

2. The VFDs of 380V ($\leq 30\text{kW}$) supports external braking resistors which are optional.
3. The VFDs of 500V ($\geq 22\text{kW}$) supports external DC reactors and external braking units, but it is necessary to remove the copper tag between P1 and (+) before connecting. DC reactors and external braking units are optional.
4. The VFDs of 500V ($\leq 18.5\text{kW}$) supports external braking resistors which are optional.
5. The VFDs of 660V supports external DC reactors and external braking units, but it is necessary to remove the copper tag between P1 and (+) before connecting. DC reactors and external braking units are optional.

3.3 Product specification

Function		Specification
Power input	Input voltage (V)	AC 3PH 380V (-15%)–440V (+10%) Rated voltage: 380V; AC 3PH 380V (-10%)–550V (+10%) Rated voltage: 500V; AC 3PH 520V (-15%)–690V (+10%) Rated voltage: 660V
	Input current (A)	Refer to section 3.6 "Rated specifications"
	Input frequency (Hz)	50Hz or 60Hz Allowed range: 47–63Hz
Power output	Output voltage (V)	0–input voltage
	Output current (A)	Refer to section 3.6 "Rated specifications"
	Output power (kW)	Refer to section 3.6 "Rated specifications"
	Output frequency (Hz)	0–400Hz
Technical control feature	Control mode	SVPWM, sensorless vector control
	Motor type	Asynchronous motor and permanent magnet synchronous motor
	Adjustable-speed ratio	Asynchronous motor 1:200 (SVC) synchronous motor 1:20 (SVC)
	Speed control accuracy	$\pm 0.2\%$ (sensorless vector control)
	Speed fluctuation	$\pm 0.3\%$ (sensorless vector control)
	Torque response	$< 20\text{ms}$ (sensorless vector control)
	Torque control accuracy	10%(sensorless vector control)
	Starting torque	Asynchronous motor: 0.25Hz/150% (SVC)

Function		Specification
		Synchronous motor: 2.5 Hz/150% (SVC)
	Overload capability	150% of rated current: 1 minute 180% of rated current: 10 seconds 200% of rated current: 1 second
Running control feature	Frequency setting method	Digital setting, analog setting, pulse frequency setting, multi-step speed running setting, simple PLC setting, PID setting, Modbus communication setting, PROFIBUS communication setting. Switch between the combination and single setting channel.
	Auto-adjustment of the voltage	Keep constant voltage automatically when the grid voltage transients
	Fault protection	Provide more than 30 fault protection functions: overcurrent, overvoltage, undervoltage, overheating, phase loss and overload, etc.
	Restart after rotating speed tracking	Smooth starting of the rotating motor
Peripheral interface	Terminal analog input resolution	≤ 20mV
	Terminal switch input resolution	≤ 2ms
	Analog input	2 (AI1, AI2) 0–10V/0–20mA and 1 (AI3) -10–10V
	Analog output	2 (AO1, AO2) 0–10V /0–20mA
	Digital input	8 common inputs, the Max. frequency: 1kHz, internal impedance: 3.3kΩ; 1 high speed input, the Max. frequency: 50kHz
	Digital output	1 high speed pulse output, the Max. frequency: 50kHz; 1 Y terminal open collector output
	Relay output	2 programmable relay outputs RO1A NO, RO1B NC, RO1C common terminal RO2A NO, RO2B NC, RO2C common terminal Contactor capability: 3A/AC250V,1A/DC30V
Others	Mountable method	Wall, flange and floor mountable
	Temperature of the running environment	-10–50°C, derate above 40°C
	Average non-fault time	2 years (25°C ambient temperature)
	Protective degree	IP20
	Cooling	Air-cooling

Function		Specification
	Pollution degree	Degree 2
	Braking unit	Built-in for VFDs of 380V ($\leq 30\text{kW}$), optional for VFDs of 380V ($\geq 37\text{kW}$) Built-in for VFDs of 500V ($\leq 18.5\text{kW}$), optional for VFDs of 500V ($\geq 22\text{kW}$) Optional for VFDs of 660V
	EMC filter	The whole series of 380V VFDs can meet the requirements of level C3 stipulated in IEC61800-3. External filters that meet the requirements of level C2 stipulated in IEC61800-3 are optional.

3.4 Name plate

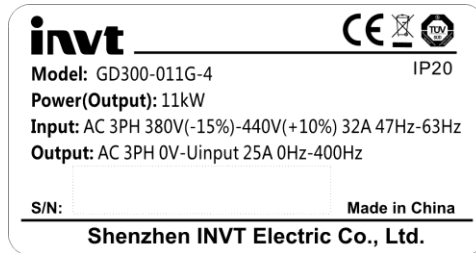

Figure 3-6 Name plate

Note: The CE/TUV/IP20 marking is displayed on the top right only when the corresponding CE/TUV/IP20 certification is obtained.

3.5 Model code

The model code contains information about the VFD. You can find the model code on the name plate on the VFD or the simplified name plate.

GD300 – 5R5G – 4

① ② ③

Figure 3-7 Product type

Field	No.	Detailed description	Detailed content
Abbreviation	①	Product abbreviation	GD300 is short for Goodrive300.
Rated power	②	Power range + Load type	5R5—5.5kW G—Constant torque load
Voltage degree	③	Voltage degree	4: AC 3PH 380V (-15%)—440V (+10%)

Field	No.	Detailed description	Detailed content
			Rated voltage: 380V; 5: AC 3PH 380V (-10%)–550V (+10%) Rated voltage: 500V; 6: AC 3PH 520V (-15%)–690V (+10%) Rated voltage: 660V

3.6 Rated specifications

3.6.1 AC 3PH 380V (-15%)–440V (+10%)

Model	Rated output power (kW)	Rated input current (A)	Rated output current (A)
GD300-1R5G-4	1.5	5.0	3.7
GD300-2R2G-4	2.2	5.8	5
GD300-004G-4	4	13.5	9.5
GD300-5R5G-4	5.5	19.5	14
GD300-7R5G-4	7.5	25	18.5
GD300-011G-4	11	32	25
GD300-015G-4	15	40	32
GD300-018G-4	18.5	47	38
GD300-022G-4	22	56	45
GD300-030G-4	30	70	60
GD300-037G-4	37	80	75
GD300-045G-4	45	94	92
GD300-055G-4	55	128	115
GD300-075G-4	75	160	150
GD300-090G-4	90	190	180
GD300-110G-4	110	225	215
GD300-132G-4	132	265	260
GD300-160G-4	160	310	305
GD300-200G-4	200	385	380
GD300-220G-4	220	430	425
GD300-250G-4	250	485	480
GD300-280G-4	280	545	530
GD300-315G-4	315	610	600
GD300-350G-4	350	625	650
GD300-400G-4	400	715	720
GD300-500G-4	500	890	860

Note:

1. The input current of VFDs 1.5–315kW is detected when the input voltage is 380V and there are no DC reactors and input/output reactors.
2. The input current of VFDs 350–500kW is detected when the input voltage is 380V and there are input reactors.
3. The rated output current is defined as the output current generated when the output voltage is 380V.
4. Within the allowed input voltage range, the output current cannot exceed the rated output current, and the output power cannot exceed the rated output power.

3.6.2 AC 3PH 380V (-10%)–550V (+10%)

Model	Rated output power (kW)	Rated input current (A)	Rated output current (A)
GD300-004G-5	4	11	8
GD300-5R5G-5	5.5	15	10
GD300-7R5G-5	7.5	19	14
GD300-011G-5	11	26	20
GD300-015G-5	15	32	26
GD300-018G-5	18.5	40	34
GD300-022G-5	22	48	42
GD300-030G-5	30	60	53
GD300-037G-5	37	66	63
GD300-045G-5	45	78	75
GD300-055G-5	55	95	92
GD300-075G-5	75	126	120

Note:

1. The input current of VFDs 1.5–75kW is detected when the input voltage is 500V and there are no DC reactors and input/output reactors.
2. The rated output current is defined as the output current generated when the output voltage is 500V.
3. Within the allowed input voltage range, the output current cannot exceed the rated output current, and the output power cannot exceed the rated output power.

3.6.3 AC 3PH 520V (-15%)–690V (+10%)

Model	Rated output power (kW)	Rated input current (A)	Rated output current (A)
GD300-022G-6	22	35	27
GD300-030G-6	30	40	35
GD300-037G-6	37	47	45
GD300-045G-6	45	52	52

Model	Rated output power (kW)	Rated input current (A)	Rated output current (A)
GD300-055G-6	55	65	62
GD300-075G-6	75	85	86
GD300-090G-6	90	95	98
GD300-110G-6	110	118	120
GD300-132G-6	132	145	150
GD300-160G-6	160	165	175
GD300-185G-6	185	190	200
GD300-200G-6	200	210	220
GD300-220G-6	220	230	240
GD300-250G-6	250	255	270
GD300-280G-6	280	286	300
GD300-315G-6	315	334	350
GD300-350G-6	350	360	380
GD300-400G-6	400	411	430
GD300-500G-6	500	518	540
GD300-560G-6	560	578	600
GD300-630G-6	630	655	680

Note:

1. The input current of VFDs 22–350kW is detected when the input voltage is 660V and there are no DC reactors and input/output reactors.
2. The input current of VFDs 400–630kW is detected when the input voltage is 660V and there are input reactors.
3. The rated output current is defined as the output current generated when the output voltage is 660V.
4. Within the allowed input voltage range, the output current cannot exceed the rated output current, and the output power cannot exceed the rated output power.

3.7 Structure diagram

Figure 3-8 shows the layout of the VFD (taking the VFD of 380V 30kW as an example).

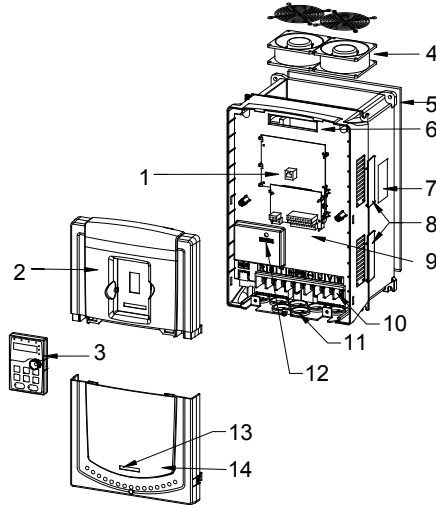



Figure 3-8 Product structure

No.	Name	Description
1	Keypad port	Connect the keypad.
2	Upper cover	Protect the internal parts and components.
3	Keypad	See Chapter 5 "Keypad operation procedure" for detailed information.
4	Cooling fan	See Chapter 9 "Maintenance and hardware fault diagnostics" for detailed information.
5	Wiring port	Connect to the control board and the drive board.
6	Name plate	See Chapter 3 "Product overview" for detailed information.
7	Side cover	Optional. The side cover will increase the protective degree of the VFD, however, the internal temperature of the VFD will also increase, so it is necessary to derate the VFD at the same time.
8	Control terminals	See Chapter 4 "Installation guide" for detailed information.
9	Main circuit terminals	See Chapter 4 "Installation guide" for detailed information.
10	Main circuit cable port	Fix the main circuit cable.
11	POWER light	Power indicator.
12	Simple name plate	See section 3.5 "Model code" for detailed information.
13	Lower cover	Protect the internal parts and components.

Chapter 4 Installation guide

4.1 What this chapter contains

The chapter describes the mechanical installation and electrical installation.

	<ul style="list-style-type: none"> • Only qualified electricians are allowed to carry out what described in this chapter. Please operate as the instructions in Chapter 1 "Safety precautions". Ignoring these may cause physical injury or death or damage to the devices. • Ensure the power supply of the VFD is disconnected during the operation. Wait for at least the time designated until the POWER indicator is off after the disconnection if the power supply is applied. It is recommended to use the multimeter to monitor that the DC bus voltage of the drive is under 36V. • The installation and design of the VFD should be complied with the requirement of the local laws and regulations in the installation site. If the installation infringes the requirement, our company will exempt from any responsibility. Additionally, if users do not comply with the suggestion, some damage beyond the assured maintenance range may occur.
---	---

4.2 Mechanical installation

4.2.1 Installation environment

The installation environment is the safeguard for the full play and long-term stable function of the VFD.

Check the installation environment as followings:

Environment	Conditions
Installation site	Indoor
Environment temperature	<p>-10~+50°C</p> <p>If the ambient temperature of the VFD is above 40°C, derate 1% for every additional 1°C.</p> <p>It is not recommended to use the VFD if the ambient temperature is above 50°C.</p> <p>In order to improve the reliability of the device, do not use the VFD if the ambient temperature changes frequently.</p> <p>Please provide cooling fan or air conditioner to control the internal ambient temperature below the required one if the VFD is used in a close space such as in the control cabinet.</p> <p>When the temperature is too low, if the VFD needs to restart to run after a long stop, it is necessary to provide an external heating device to increase the internal temperature, otherwise damage to the devices may occur.</p>
Humidity	<p>RH≤90%</p> <p>No condensation is allowed.</p> <p>The maximum relative humidity should be equal to or less than 60% in</p>

Environment	Conditions
	corrosive air.
Storage temperature	-30~+60°C
Running environment condition	The installation site of the VFD should: keep away from the electromagnetic radiation source; keep away from contaminative air, such as corrosive gas, oil mist and flammable gas; ensure foreign objects, such as metal power, dust, oil, water cannot enter into the VFD (do not install the VFD on the flammable materials such as wood); keep away from direct sunlight, oil mist, steam and vibration environment.
Altitude	When the altitude exceeds 1000m but is lower than 3000m, derate 1% for every additional 100m; When the altitude exceeds 2000m, configure an isolation transformer on the input end of the VFD. When the altitude exceeds 3000m but is lower than 5000m, contact us for technical consultation. Do not use the VFD at an altitude higher than 5000m.
Vibration	$\leq 5.88\text{m/s}^2$ (0.6g)
Installation direction	The VFD should be installed upright to ensure the cooling effect.

Note:

- ◆ Goodrive300 series VFDs should be installed in a clean and ventilated environment according to enclosure classification.
- ◆ Cooling air must be clean without corrosive gas or electrically conductive dust.

4.2.2 Installation direction

The VFD may be installed on the wall or in a cabinet.

The VFD must be installed upright. Check the installation site according to the requirements below. Refer to Appendix C "Dimension drawings" in the appendix for frame details.

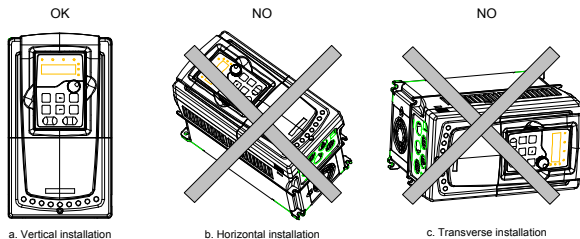

Figure 4-1 Installation direction of the VFD

4.2.3 Installation mode

The VFD can be installed in three different ways, depending on the frame size:

- a) Wall mounting, applicable for VFDs of 380V ($\leq 315\text{kW}$), 500V ($\leq 75\text{kW}$), and 660V ($\leq 350\text{kW}$)
- b) Flange mounting, applicable for VFDs of 380V ($\leq 200\text{kW}$), 500V ($\leq 75\text{kW}$), and 660V ($\leq 200\text{kW}$)
- c) Floor mounting, applicable for VFDs of 380V (220–500kW) and 660V (250–630kW)

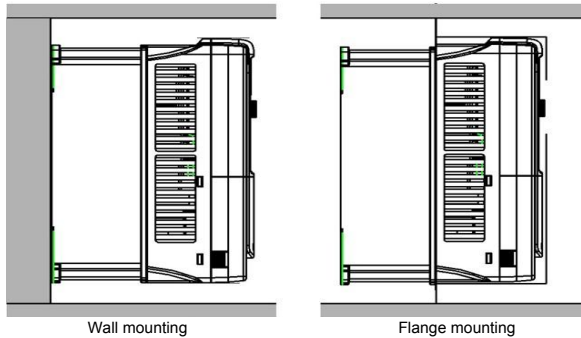

Figure 4-2 Installation mode

- (1) Mark the hole location. The location of the holes is shown in Appendix C "Dimension drawings".
- (2) Fix the screws or bolts to the marked locations.
- (3) Put the VFD against the wall.
- (4) Tighten the screws in the wall securely.

Note:

The flange installation of the VFDs of 380V 1.5–30kW and 500V 4–18.5kW need flange board, while the flange installation of the VFDs of 380V 37–200kW, the flange installation of the VFDs of 500V 22–75kW and 660V 22–220kW does not need.

The VFDs of 380V 220–315kW and 660V 250–350kW need optional bases, there is an input AC reactor (or DC reactor) and output AC reactor on the base.

4.2.4 Installation of one VFD

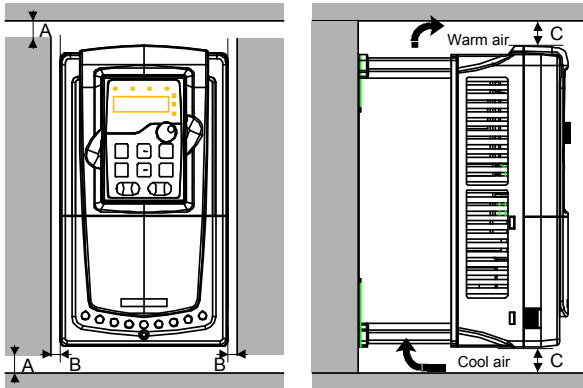

Figure 4-3 Stand-alone installation

Note: The minimum space of B and C is 100 mm.

4.2.5 Installation of multiple VFDs

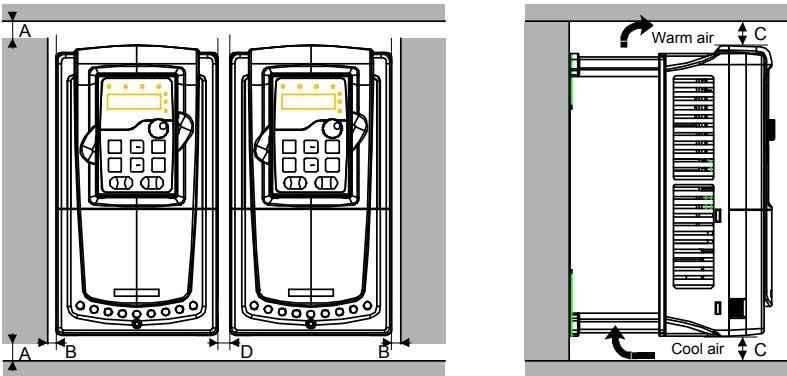

Figure 4-4 Parallel installation

Note:

- ◆ Before installing the different sizes VFDs, please align their top position for the convenience of later maintenance.
- ◆ The minimum space of B, D and C is 100 mm.

4.2.6 Vertical installation

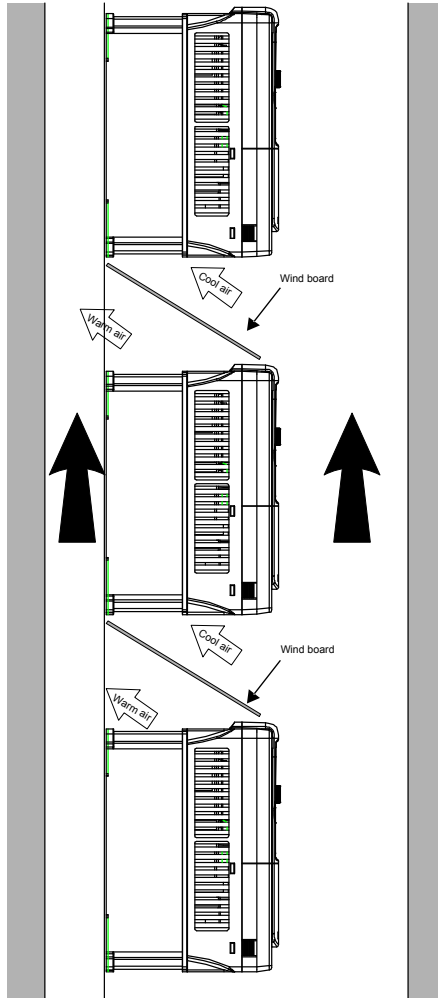

Figure 4-5 Vertical installation

Note: Windscreen should be installed in vertical installation to prevent mutual impact and insufficient cooling.

4.2.7 Tilt installation

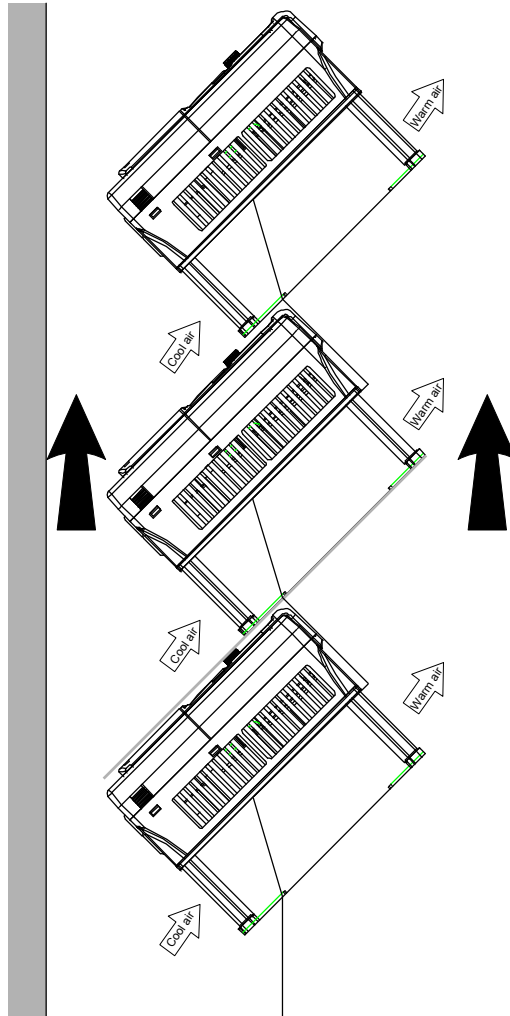

Figure 4-6 Tilt installation

Note: Ensure the separation of the wind input and output channels in tilt installation to prevent mutual impact.

4.3 Standard wiring

4.3.1 Main circuit connection diagram

4.3.1.1 Main circuit connection diagram of VFDs of AC 3PH 380V (-15%)–440V (+10%)

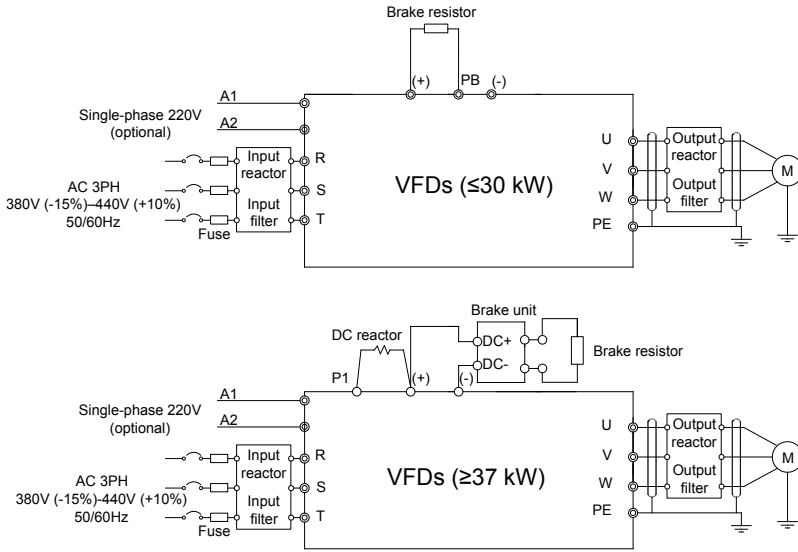

Figure 4-7 Main circuit connection diagram of 380V VFDs

Note:

- ◆ The fuse, DC reactor, braking unit, braking resistor, input reactor, input filter, output reactor, output filter are optional parts. Please refer to Appendix D "Peripheral options and parts" for detailed information.
- ◆ **A1** and **A2** are optional parts.
- ◆ **P1** and **(+)** are short circuited in factory for the VFDs of 380V (≥ 37 kW), if need to connect with the DC reactor, please remove the contact tag between **P1** and **(+)**.
- ◆ Before connecting the braking resistor cable, remove the yellow labels of PB, (+), and (-) from the terminal blocks. Otherwise, poor connection may occur.

4.3.1.2 Main circuit connection diagram of VFDs of 3PH 380V (-10%)–550V (+10%)

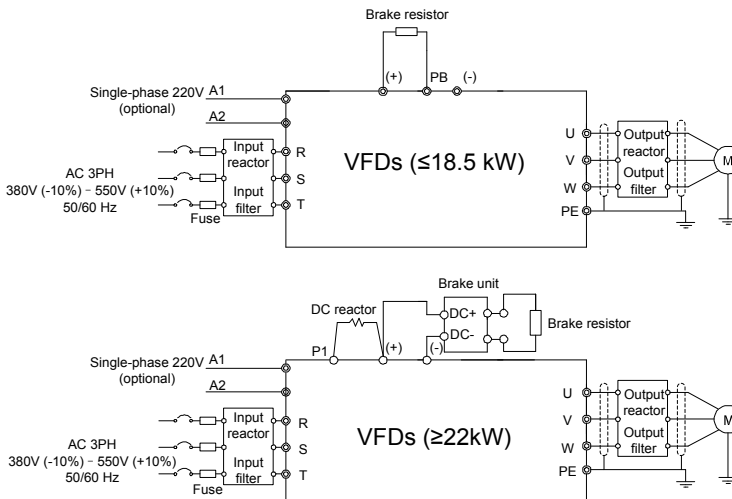

Figure 4-8 Connection diagram of main circuit for the VFDs of 500V

Note:

- ◆ The fuse, DC reactor, braking unit, braking resistor, input reactor, input filter, output reactor, output filter are optional parts. Please refer to Appendix D "Peripheral options and parts" for detailed information.
- ◆ A1 and A2 are optional parts.
- ◆ P1 and (+) are short circuited in factory for the VFDs of 500V ($\geq 22\text{kW}$), if need to connect with the DC reactor, please remove the contact tag between P1 and (+).
- ◆ Before connecting the braking resistor cable, remove the yellow labels of PB, (+), and (-) from the terminal blocks. Otherwise, poor connection may occur.

4.3.1.3 Main circuit connection diagram of VFDs of AC 3PH 520V (-15%)–690V (+10%)

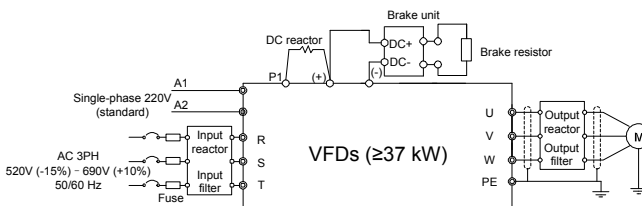

Figure 4-9 Connection diagram of main circuit for the VFDs of 660V

Note:

- ◆ The fuse, DC reactor, braking unit, braking resistor, input reactor, input filter, output reactor,

output filter are optional parts. Please refer to Appendix D "Peripheral options and parts" for detailed information.

- ◆ A1 and A2 are standard parts.
- ◆ P1 and (+) are short circuited in factory, if it needs to connect with the DC reactor, please remove the contact tag between P1 and (+).
- ◆ Before connecting the braking resistor cable, remove the yellow labels of PB, (+), and (-) from the terminal blocks. Otherwise, poor connection may occur.

4.3.2 Main circuit terminals diagram

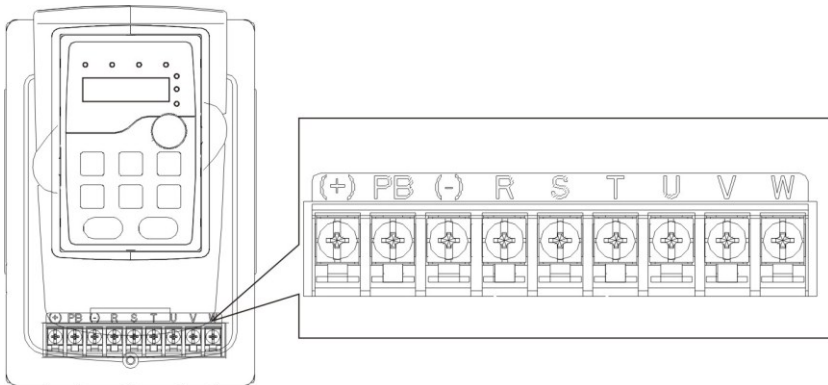

Figure 4-10 Main circuit terminals diagram of VFDs of 380V (1.5–2.2kW)

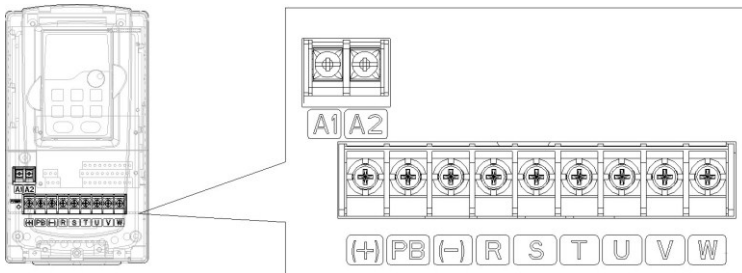

Figure 4-11 Main circuit terminals diagram of VFDs of 380V (4–5.5kW)

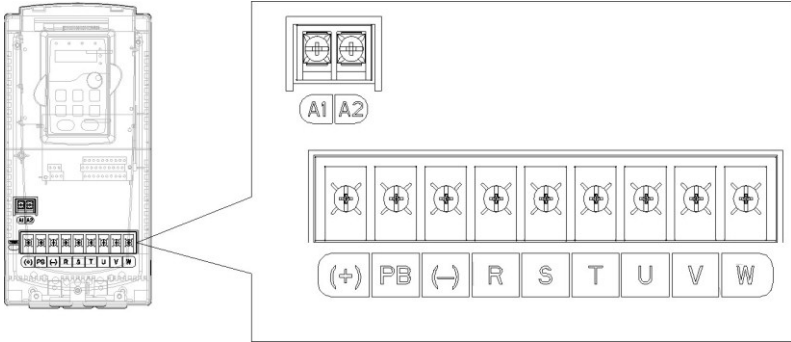

Figure 4-12 Main circuit terminals diagram of VFDs of 380V (7.5–11kW) and 500V (4–18.5kW)

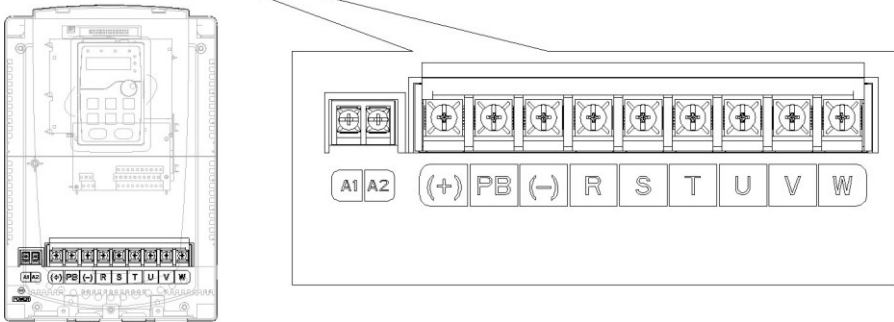

Figure 4-13 Main circuit terminals diagram of VFDs of 380V (15–18kW)

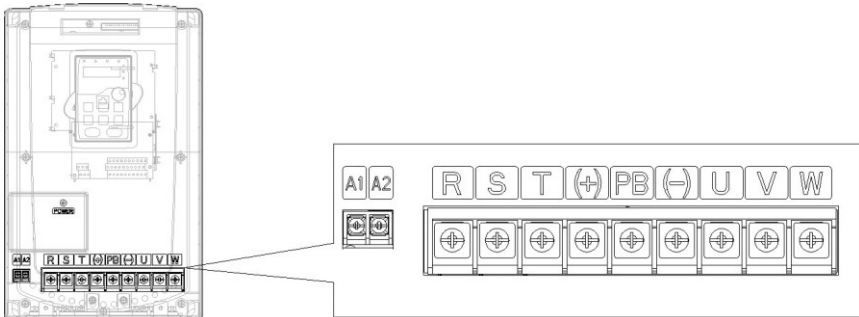

Figure 4-14 Main circuit terminals diagram of VFDs of 380V (22–30kW)

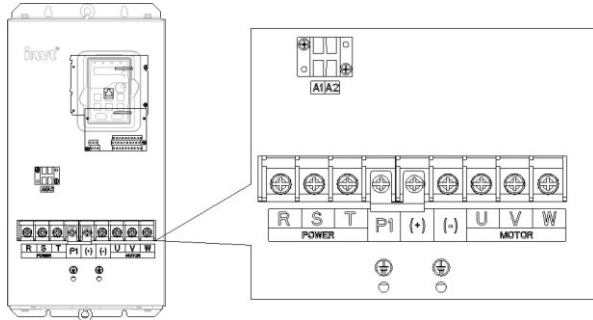

Figure 4-15 Main circuit terminals diagram of VFDs of 380V (37–55kW), 500V (22–55kW), and 660V (22–45kW)

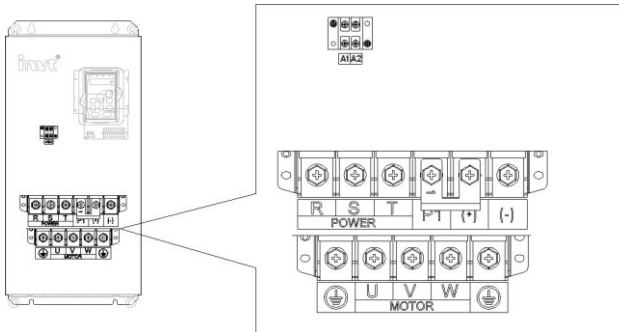

Figure 4-16 Main circuit terminals diagram of VFDs of 380V (75–110kW), 500V (75kW), and 660V (55–132kW)

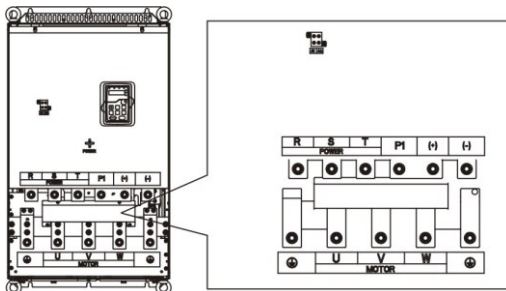

Figure 4-17 Main circuit terminals diagram of VFDs of 380V (132–200kW) and 660V (160–220kW)

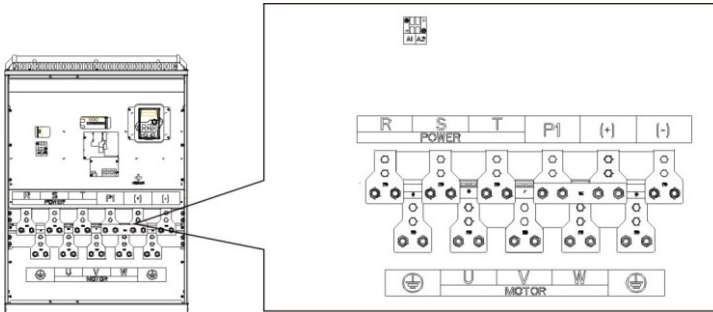

Figure 4-18 Main circuit terminals diagram of VFDs of 380V (220–315kW) and 660V (250–350kW)

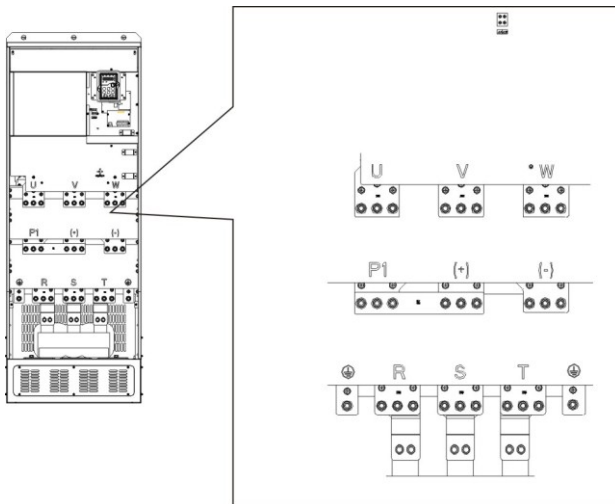

Figure 4-19 Main circuit terminals diagram of VFDs of 380V (350–500kW) and 660V (400–630kW)

Terminal	Terminal name		Function description
	380V (≤30kW)	380V (≥37kW)	
	500V (≤18.5kW)	500V (≥22kW)	
	660V		
R,S,T	Power input of the main circuit		3-phase AC input terminals which are generally connected with the power supply.
U,V,W	VFD output		3-phase AC output terminals which are generally connected with the motor.

Terminal	Terminal name		Function description
	380V (≤30kW)	380V (≥37kW)	
	500V (≤18.5kW)	500V (≥22kW)	
	660V		
P1	/	DC reactor terminal 1	P1 and (+) are connected with the terminals of the DC reactor. (+) and (-) are connected with the terminals of the braking unit. PB and (+) are connected with the terminals of the braking resistor.
(+)	Braking resistor 1	DC reactor terminal 2, braking unit terminal 1	
(-)	/	Braking unit terminal 2	
PB	Braking resistor 2	/	
PE	380V/500V/660V: the grounding resistor is less than 10 Ohm		Protective grounding terminals. Every machine is provided with 2 PE terminals as the standard configuration. These terminals must be grounded with proper techniques.
A1 and A2	Control power supply terminal		Optional parts for 380V VFDs, standard parts for 660V VFDs (connected with external 220V control power supply), enabling a VFD to use an auxiliary power supply when no power is applied in the input main circuit, thus facilitating the commissioning of the VFD and improving safety during the commissioning.

Note:

- Do not use an asymmetrically constructed motor cable. If there is a symmetrically constructed grounding conductor in the motor cable in addition to the conductive shield, connect the grounding conductor to the grounding terminal at the VFD and motor ends.
- Braking resistor, braking unit and DC reactor are optional parts.
- Route the motor cable, input power cable and control cables separately.
- If the terminal description is "/", the machine does not provide the terminal as the external terminal.

4.3.3 Main circuit terminal wiring

1. Connect the ground line of input power cable to the ground terminal of VFD (PE) directly, and connect 3PH input cable to R, S and T and fasten up.
2. Connect the ground line of motor cable to the ground terminal of the VFD, and connect the 3PH motor cable to U, V, W and fasten up.
3. Connect the brake resistor which carries cables to the designated position.

- Fasten up all the cables on the outside of the VFD if allowed.

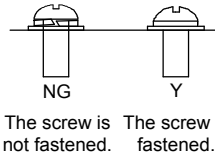

Figure 4-20 Correct installation of the screw

4.3.4 Control circuit wiring diagram

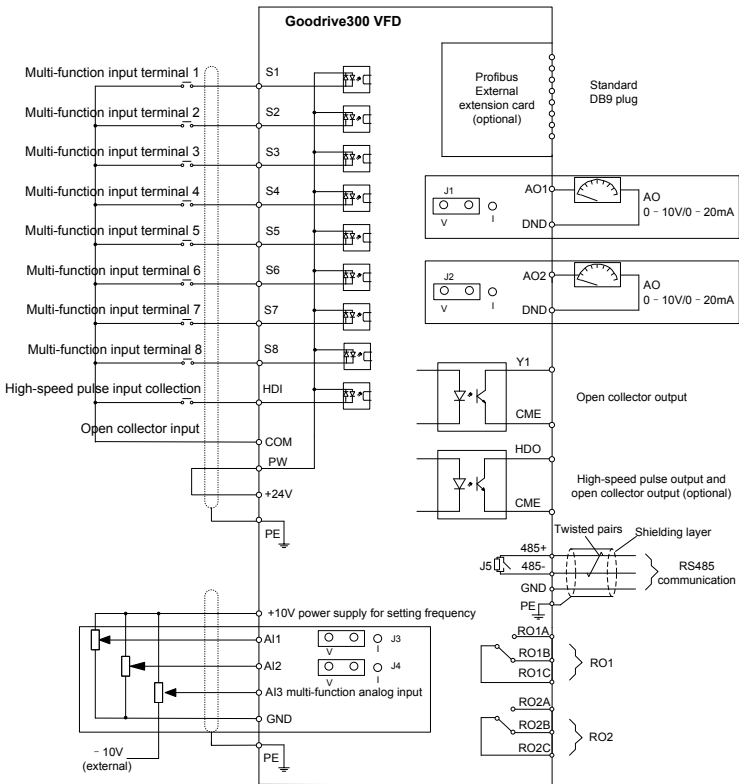

Figure 4-21 Control circuit wiring

4.3.5 Control circuit terminal diagram

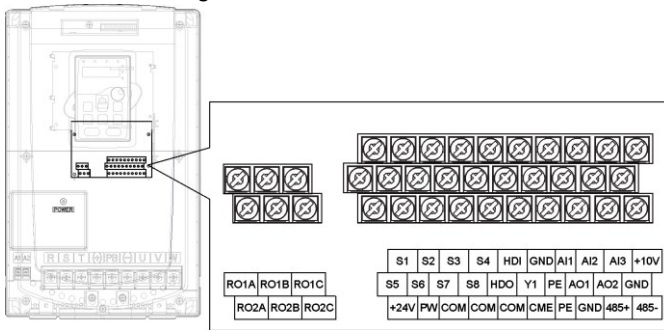
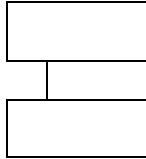

Figure 4-22 Control circuit terminals

Terminal name	Description
+10V	Local power supply +10 V
AI1	1. Input range: AI1/AI2 voltage and current can be chosen: 0–10 V/0–20mA; AI1 can be shifted by J3 while AI2 can be shifted by J4; AI3: -10 V→+10 V 2. Input impedance: voltage input: 20kΩ; current input: 500Ω 3. Resolution: the minimum one is 5m V when 10 V corresponds to 50 Hz 4. Deviation ±1%, 25°C
AI2	
AI3	
GND	+10 V reference null potential
AO1	1. Output range: 0–10 V or 0–20mA; The voltage or the current output is depended on the jumper. AO1 is switched by J1 and AO2 is switched by J2 2. Deviation±1%, 25°C
AO2	

Terminal name	Description
RO1A	RO1 relay output; RO1A is NO, RO1B is NC, RO1C is common port Contact capacity: 3A/AC250V, 1A/DC30V
RO1B	
RO1C	
RO2A	RO2 relay output; RO2A is NO, RO2B is NC, RO2C is common port Contact capacity: 3A/AC250V, 1A/DC30V
RO2B	
RO2C	



Terminal name	Description
HDO	1. Switch capacity: 200mA/30V; 2. Range of output frequency: 0–50kHz
COM	Common port of +24V
CME	Common port of open collector output
Y	1. Switch capacity: 200mA/30V; 2. Range of output frequency: 0–1kHz
485+	For 485 communication port, 485 differential signal port and standard 485 communication interfaces, use twisted pairs or shielded cables.
485-	

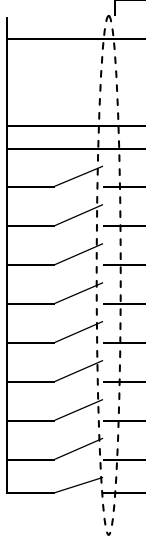

Terminal name	Description
PE	Grounding terminal
PW	Provide input digital working power from external to internal; Voltage range: 12–30V.
24V	The VFD provides user power; the maximum output current is 200mA
COM	Common port of +24V
S1	Digital input 1
S2	Digital input 2
S3	Digital input 3
S4	Digital input 4
S5	Digital input 5
S6	Digital input 6
S7	Digital input 7
S8	Digital input 8
HDI	Besides S1–S8, it can also act as high frequency pulse input channel Max. input frequency: 50kHz

4.3.6 Input /Output signal connection figure

Use U-shaped short-circuit connectors to set NPN mode or PNP mode and the internal or external power supply. The default setting is NPN internal mode.

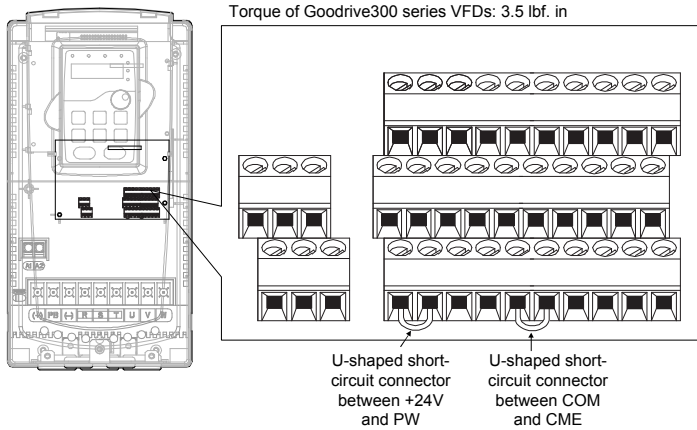

Figure 4-23 U-shaped short-circuit positions

If the signal is from NPN transistor, set the U-shaped short-circuit connector between +24V and PW as follows according to the used power supply.

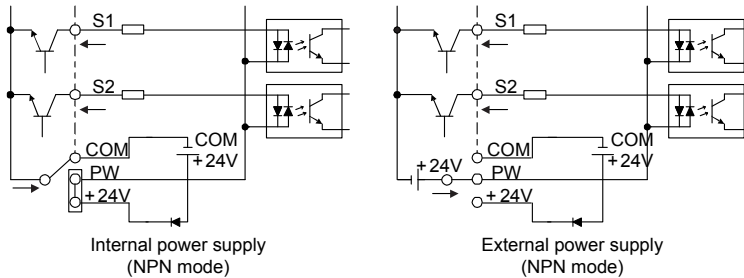

Figure 4-24 NPN modes

If the signal is from PNP transistor, set the U-shaped short-circuit connector as follows according to the used power supply.

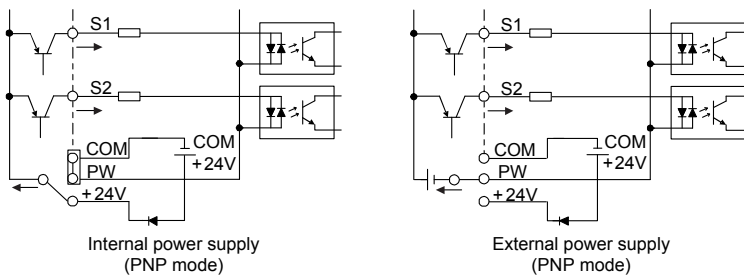

Figure 4-25 PNP modes

4.4 Layout protection

4.4.1 Protecting the VFD and input power cable in short-circuit situations

Protect the VFD and input power cable in short circuit situations and against thermal overload.

Arrange the protection according to the following guidelines.

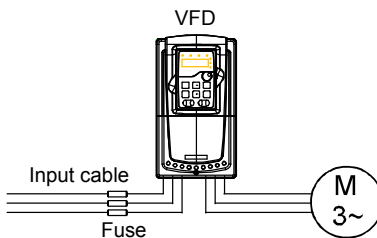

Figure 4-26 Fuse configuration

Note: Select the fuse as the manual indicated. The fuse will protect the input power cable from damage in short-circuit situations. It will protect the surrounding devices when the internal of the VFD is short circuited.

4.4.2 Protecting the motor and motor cable in short-circuit situations

The VFD protects the motor and motor cable in a short-circuit situation when the motor cable is dimensioned according to the rated current of the VFD. No additional protection devices are needed.



- If the VFD is connected to multiple motors, a separate thermal overload switch or a circuit breaker must be used for protecting each cable and motor. These devices may require a separate fuse to cut off the short-circuit current.

4.4.3 Protecting the motor against thermal overload

According to regulations, the motor must be protected against thermal overload and the current must be switched off when overload is detected. The VFD includes a motor thermal protection function that protects the motor and closes the output to switch off the current when necessary.

4.4.4 Implementing a bypass connection

It is necessary to set power frequency and variable frequency conversion circuits for the assurance of continuous normal work of the VFD if faults occur in some significant situations.

In some special situations, for example, if it is only used in soft start, the VFD can be converted into power frequency running after starting and some corresponding bypass should be added.



- Never connect the supply power to the VFD output terminals U, V and W. Power line voltage applied to the output can result in permanent damage to the VFD.

If frequent shifting is required, employ mechanical interlockswitches or contactors to ensure that the motor terminals are not simultaneously connected to the AC power line and VFD output terminals.

Chapter 5 Keypad operation procedure

5.1 What this chapter contains

This chapter describes the keys, indicators, and display of the keypad, and how to view and modify function code settings through the keypad.

5.2 Keypad

The keypad is used to control Goodrive300 series VFDs, read the state data and adjust parameters. If you need to use the keypad in another place rather than on the VFD, use a network cable with a standard RJ45 crystal head as the extension cable.

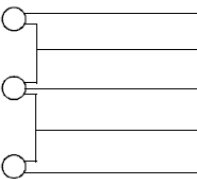









Figure 5-1 Keypad

Note:

1. The LED keypad is standard but the LCD keypad which can support various languages, parameters copy and 10-line displaying is optional.
2. It is necessary to use M3 screw or installation bracket to fix the external keypad. The installation bracket for VFDs of 380V 1.5–30kW and 500V 4–18.5kW is optional but it is standard for the VFDs of 380V 37–500kW, 500V 22–75kW and 660V.

No.	Name	Description	
1	State LED	RUN/TUNE	LED off means that the VFD is in the stopping state; LED blinking means the VFD is in the parameter autotune state; LED on means the VFD is in the running state.
		FWD/REV	FED/REV LED LED off means the VFD is in the forward rotation state; LED on means the VFD is in the reverse rotation state

No.	Name	Description					
		LOCAL/REMOT	LED for keypad operation, terminals operation and remote communication control LED off means that the VFD is in the keypad operation state; LED blinking means the VFD is in the terminals operation state; LED on means the VFD is in the remote communication control state.				
		TRIP	LED for faults LED on when the VFD is in the fault state; LED off in normal state; LED blinking means the VFD is in the pre-alarm state.				
2	Unit LED	Mean the unit displayed currently					
			Hz	Frequency unit			
			A	Current unit			
			V	Voltage unit			
			RPM	Rotating speed unit			
			%	Percentage			
3	Code displaying zone	5-figure LED display displays various monitoring data and alarm code such as set frequency and output frequency.					
		Displayed character	Corresponding character	Displayed character	Corresponding character	Displayed character	Corresponding character
		0	0	1	1	2	2
		3	3	4	4	5	5
		6	6	7	7	8	8
		9	9	A	A	b	b
		C	C	d	d	E	E
		F	F	H	H	I	I
		L	L	N	N	n	n
		O	O	P	P	r	r
		S	S	t	t	U	U
		v	v	.	.	-	-

No.	Name	Description		
4	Digital potentiometer	Tuning frequency. Please refer to P08.41.		
5	Buttons		Programming key	Enter or escape from the first level menu and remove the parameter quickly.
			Entry key	Enter the menu step-by-step Confirm parameters.
			UP key	Increase data or function code progressively.
			DOWN key	Decrease data or function code progressively.
			Right-shift key	Move right to select the displaying parameter circularly in stopping and running mode. Select the parameter modifying digit during the parameter modification.
			Run key	This key is used to operate on the VFD in key operation mode.
			Stop/ Reset key	This key is used to stop in running state and it is limited by function code P07.04 This key is used to reset all control modes in the fault alarm state.
			Quick key	The function of this key is confirmed by function code P07.02.

5.3 Keypad displaying

The keypad displaying state of Goodrive300 series VFDs is divided into stopping state parameter, running state parameter, function code parameter editing state and fault alarm state and so on.

5.3.1 Displayed state of stopping parameter

When the VFD is in the stopping state, the keypad will display stopping parameters which is shown in figure 5-2.

In the stopping state, various kinds of parameters can be displayed. Select the parameters to be displayed or not by P07.07. See the instructions of P07.07 for the detailed definition of each bit.

In the stopping state, there are 14 stopping parameters can be selected to be displayed or not. They

are: set frequency, bus voltage, input terminals state, output terminals state, PID given value, PID feedback value, torque set value, AI1, AI2, AI3, HDI, PLC and the current stage of multi-step speeds, pulse counting value, length value. P07.07 can select the parameter to be displayed or not by bit and **▶/SHIFT** can shift the parameters form left to right, **QUICK/JOG** (P07.02=2) can shift the parameters form right to left.

5.3.2 Displayed state of running parameters

After the VFD receives valid running commands, the VFD will enter into the running state and the keypad will display the running parameters. **RUN/TUNE** LED on the keypad is on, while the **FWD/REV** is determined by the current running direction which is shown as figure 5-2.

In the running state, there are 24 parameters can be selected to be displayed or not. They are: running frequency, set frequency, bus voltage, output voltage, output torque, PID given value, PID feedback value, input terminals state, output terminals state, torque set value, length value, PLC and the current stage of multi-step speeds, pulse counting value, AI1, AI2, AI3, HDI, percentage of motor overload, percentage of VFD overload, ramp given value, linear speed, AC input current. P07.05 and P07.06 can select the parameter to be displayed or not by bit and **▶/SHIFT** can shift the parameters form left to right, **QUICK/JOG** (P07.02=2) can shift the parameters from right to left.

5.3.3 Displayed state of fault

If the VFD detects the fault signal, it will enter into the fault pre-alarm displaying state. The keypad will display the fault code by flicking. The **TRIP** LED on the keypad is on, and the fault reset can be operated by the **STOP/RST** on the keypad, control terminals or communication commands.

5.3.4 Displayed state of function codes editing

In the state of stopping, running or fault, press **PRG/ESC** to enter into the editing state (if there is a password, see P07.00).The editing state is displayed on two classes of menu, and the order is: function code group/function code number→function code parameter, press **DATA/ENT** into the displayed state of function parameter. On this state, you can press **DATA/ENT** to save the parameters or press **PRG/ESC** to retreat.

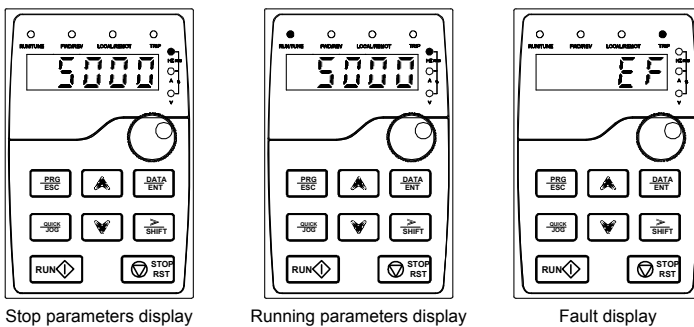

Figure 5-2 Displayed states

5.4 Keypad operation

Operate the VFD via operation panel. See the detailed structure description of function codes in the brief diagram of function codes.

5.4.1 How to modify the function codes of the VFD

The VFD has three levels menu, which are:

1. Group number of function code (first-level menu)
2. Tab of function code (second-level menu)
3. Set value of function code (third-level menu)

Remarks: Press both the **PRG/ESC** and the **DATA/ENT** can return to the second-level menu from the third-level menu. The difference is: pressing **DATA/ENT** will save the set parameters into the control panel, and then return to the second-level menu with shifting to the next function code automatically; while pressing **PRG/ESC** will directly return to the second-level menu without saving the parameters, and keep staying at the current function code.

Under the third-level menu, if the parameter has no flickering bit, it means the function code cannot be modified. The possible reasons could be:

- 1) This function code is not modifiable parameter, such as actual detected parameter, operation records and so on;
- 2) This function code is not modifiable in running state, but modifiable in stop state.

Example: Set function code P00.01 from 0 to 1.

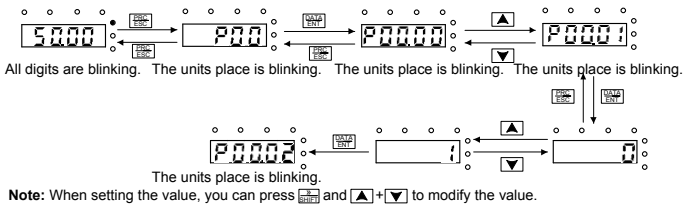

Figure 5-3 Sketch map of modifying parameters

5.4.2 How to set the password of the VFD

Goodrive300 series VFDs provide password protection function to users. Set P7.00 to gain the password and the password protection becomes valid instantly after quitting from the function code editing state. Press **PRG/ESC** again to the function code editing state, "0.0.0.0.0" will be displayed. Unless using the correct password, the operators cannot enter it.

Set P7.00 to 0 to cancel password protection function.

The password protection becomes effective instantly after retreating from the function code editing state. Press **PRG/ESC** again to the function code editing state, "0.0.0.0.0" will be displayed. Unless using the correct password, the operators cannot enter it.

Chapter 6 Function parameters

6.1 What this chapter contains

This chapter lists and describes the function parameters.

6.2 Goodrive300 general series function parameters

The function parameters of Goodrive300 series VFDs have been divided into 30 groups (P00–P29) according to the function, of which P18–P28 are reserved. Each function group contains certain function codes applying 3-level menus. For example, "P08.08" means the eighth function code in the P8 group function, P29 group is factory reserved, and users are forbidden to access these parameters.

For the convenience of function codes setting, the function group number corresponds to the first level menu, the function code corresponds to the second level menu and the function code corresponds to the third level menu.

1. Below is the instruction of the function lists:

The first line "Function code": codes of function parameter group and parameters;

The second line "Name": full name of function parameters;

The third line "Detailed illustration of parameters": detailed illustration of the function parameters

The fourth line "Default value": the original factory values of the function parameter;

The fifth line "Modify": the modifying character of function codes (the parameters can be modified or not and the modifying conditions), below is the instruction:

"○": means the set value of the parameter can be modified on stop and running state;

"⊙": means the set value of the parameter cannot be modified on the running state;

"●": means the value of the parameter is the real detection value which cannot be modified.

(The VFD has limited the automatic inspection of the modifying character of the parameters to help users avoid mismodifying)

2. "Parameter radix" is decimal (DEC), if the parameter is expressed by hex, then the parameter is separated from each other when editing. The setting range of certain bits is 0–F (hex).

3. "The default value" means the function parameter will restore to the default value during default parameters restoring. But the detected parameter or recorded value won't be restored.

4. For a better parameter protection, the VFD provides password protection to the parameters. After setting the password (set P07.00 to any non-zero number), the system will come into the state of password verification firstly after the user press **PRG/ESC** to come into the function code editing state. And then "0.0.0.0.0." will be displayed. Unless the user input right password, they cannot enter into the system. For the factory setting parameter zone, it needs correct factory password (remind that the users cannot modify the factory parameters by themselves, otherwise, if the parameter setting is incorrect, damage to the VFD may occur). If the password protection is unlocked, the user can modify

the password freely and the VFD will work as the last setting one. When P07.00 is set to 0, the password can be canceled. If P07.00 is not 0 during powering on, then the parameter is protected by the password. When modify the parameters by serial communication, the function of the password follows the above rules, too.

Function code	Name	Detailed instruction of parameters	Default value	Modify
P00 Group Basic function group				
P00.00	Speed control mode	<p>0: Sensorless vector control mode 0 (apply to AM and SM) No need to install encoders. It is suitable in cases with low frequency, big torque and high speed control accuracy for accurate speed and torque control. Compared to mode 1, this mode is more suitable for medium and small power.</p> <p>1: Sensorless vector control mode 1 (applying to AM) No need to install encoders. It is suitable in cases with high speed control accuracy for accurate speed and torque control at all power ratings.</p> <p>2: SVPWM control No need to install encoders. It can improve the control accuracy with the advantages of stable operation, valid low-frequency torque boost and current vibration suppression and the functions of slip compensation and voltage adjustment.</p> <p>Note: AM: Asynchronous motor, SM: Synchronous motor; Motor parameter autotuning must be performed on the VFD first when the vector mode is used.</p>	1	◎
P00.01	Running command channel	<p>Select the run command channel of the VFD. The control command of the VFD includes: start-up, stop, forward, reverse, jogging and fault reset.</p> <p>0: Keypad ("LOCAL/REMOT" light off) Carry out the command control by RUN, STOP/RST on the keypad.</p> <p>Set the multi-function key QUICK/JOG to FWD/REVC shifting function (P07.02=3) to change the running direction; press RUN and</p>	0	○

Function code	Name	Detailed instruction of parameters	Default value	Modify
		<p>STOP/RST simultaneously in running state to make the VFD coast to stop.</p> <p>1: Terminal ("LOCAL/REMOT" flickering) Carry out the running command control by the forward rotation, reverse rotation and forward jogging and reverse jogging of the multi-function terminals</p> <p>2: Communication ("LOCAL/REMOT" on) The running command is controlled by the upper monitor via communication</p>		
P00.02	Communication running commands	<p>Select the controlling communication command channel of the VFD.</p> <p>0: Modbus communication channel 1: PROFIBUS\CANopen communication channel 2: Ethernet communication channel 3: Reserved</p> <p>Note: 1, 2 and 3 are extension functions which need corresponding extension cards.</p>	0	○
P00.03	Max. output frequency	<p>This parameter is used to set the maximum output frequency of the VFD. Users should pay attention to this parameter because it is the foundation of the frequency setting and the speed of acceleration and deceleration.</p> <p>Setting range: P00.04–400.00Hz</p>	50.00 Hz	⊙
P00.04	Upper limit of the running frequency	<p>The upper limit of the running frequency is the upper limit of the output frequency of the VFD which is lower than or equal to the maximum frequency.</p> <p>Setting range: P00.05–P00.03 (Max. output frequency)</p>	50.00 Hz	⊙
P00.05	Lower limit of the running frequency	<p>The lower limit of the running frequency is that of the output frequency of the VFD.</p> <p>The VFD runs at the lower limit frequency if the set frequency is lower than the lower limit one.</p> <p>Note: Max. output frequency ≥ Upper limit frequency ≥ Lower limit frequency</p> <p>Setting range: 0.00Hz–P00.04 (Upper limit of the running frequency)</p>	0.00Hz	⊙

Function code	Name	Detailed instruction of parameters	Default value	Modify
P00.06	A frequency command	<p>Note: Frequency A and frequency B cannot use the same frequency setting mode. The frequency source can be set by P00.09.</p>	0	○
P00.07	B frequency command	<p>0: Keypad Modify the value P00.10 (set the frequency by keypad) to modify the frequency by the keypad. 1: AI1 2: AI2 3: AI3 Set the frequency by analog input terminals. Goodrive300 series VFDs provide 3 ways analog input terminals as the standard configuration, of which AI1/AI2 are the voltage/current option (0–10V/0–20mA) which can be shifted by jumpers; while AI3 is voltage input (-10V–+10V). Note: when analog AI1/AI2 select 0–20mA input, the corresponding voltage of 20mA is 10V. 100.0% of the analog input setting corresponds to the maximum frequency (function code P00.03) in forward direction and -100.0% corresponds to the maximum frequency in reverse direction (function code P00.03) 4: High-speed pulse HDI setting The frequency is set by high-speed pulse terminals. Goodrive300 series VFDs provide 1 high speed pulse input as the standard configuration. The pulse frequency range is 0.00–50.00kHz. 100.0% of the high speed pulse input setting corresponds to the maximum frequency in forward direction (P00.03) and -100.0% corresponds to the maximum frequency in reverse direction (P00.03). Note: The pulse setting can only be input by multi-function terminals HDI. Set P05.00 (HDI input selection) to high speed pulse input, and set P05.49 (HDI high speed pulse input function selection) to frequency setting input.</p>	2	○

Function code	Name	Detailed instruction of parameters	Default value	Modify
		<p>5: Simple PLC program setting The VFD runs at simple PLC program mode when P00.06=5 or P00.07=5. Set P10 (simple PLC and multi-step speed control) to select the running frequency, running direction, ACC/DEC time and the keeping time of corresponding stage. See the function description of P10 for detailed information.</p> <p>6: Multi-step speed running The VFD runs at multi-step speed mode when P00.06=6 or P00.07=6. Set P05 to select the current running stage, and set P10 to select the current running frequency. The multi-step speed has the priority when P00.06 or P00.07 does not equal to 6, but the setting stage can only be the 1–15 stage. The setting stage is 1–15 if P00.06 or P00.07 equals to 6.</p> <p>7: PID control setting The running mode of the VFD is process PID control when P00.06=7 or P00.07=7. It is necessary to set P09. The running frequency of the VFD is the value after PID effect. See P09 for the detailed information of the given source, given value, feedback source of PID.</p> <p>8: Modbus communication setting The frequency is set by Modbus communication. See P14 for detailed information.</p> <p>9: PROFIBUS/CANopen communication setting The frequency is set by PROFIBUS/ CANopen communication. See P15 for the detailed information.</p> <p>10: Ethernet communication setting(reserved)</p> <p>11: Reserved</p>		
P00.08	B frequency command reference	<p>0: Max. output frequency, 100% of B frequency setting corresponds to the maximum output frequency</p> <p>1: A frequency command, 100% of B frequency</p>	0	○

Function code	Name	Detailed instruction of parameters	Default value	Modify
		setting corresponds to the maximum output frequency. Select this setting if it needs to adjust on the base of A frequency command.		
P00.09	Combination of setting sources	<p>0: A, the current frequency setting is A frequency command</p> <p>1: B, the current frequency setting is B frequency command</p> <p>2: A+B, the current frequency setting is A frequency command + B frequency command</p> <p>3: A-B, the current frequency setting is A frequency command - B frequency command</p> <p>4: Max(A, B): The bigger one between A frequency command and B frequency is the set frequency.</p> <p>5: Min (A, B): The lower one between A frequency command and B frequency is the set frequency.</p> <p>Note: The combination manner can be shifted by P5 (terminal function).</p>	0	○
P00.10	Keypad set frequency	<p>When A and B frequency commands are selected as "keypad setting", the value of the function code is the original setting one of the frequency data of the VFD.</p> <p>Setting range: 0.00 Hz–P00.03 (Max. frequency)</p>	50.00 Hz	○
P00.11	ACC time 1	<p>ACC time means the time needed if the VFD speeds up from 0Hz to the Max. One (P00.03).</p> <p>DEC time means the time needed if the VFD speeds down from the Max. Output frequency to 0Hz (P00.03).</p>	Depend on model	○
P00.12	DEC time 1	<p>Goodrive300 series VFDs define four groups of ACC/DEC time which can be selected by P05. The factory default ACC/DEC time of the VFD is the first group.</p> <p>Setting range of P00.11 and P00.12: 0.0–3600.0s</p>	Depend on model	○
P00.13	Running direction	<p>0: Runs at the default direction, the VFD runs in the forward direction. FWD/REV indicator is off.</p> <p>1: Runs at the reverse direction, the VFD runs in</p>	0	○

Function code	Name	Detailed instruction of parameters	Default value	Modify																																				
		<p>the reverse direction. FWD/REV indicator is on. Modify the function code to shift the rotation direction of the motor. This effect equals to the shifting the rotation direction by adjusting either two of the motor lines (U, V and W). The motor rotation direction can be changed by QUICK/JOG on the keypad. Refer to parameter P07.02.</p> <p>Note: When the function parameter comes back to the default value, the motor's running direction will come back to the factory default state, too. In some cases it should be used with caution after commissioning if the change of rotation direction is disabled.</p> <p>2: Forbid to run in reverse direction: It can be used in some special cases if the reverse running is disabled.</p>																																						
P00.14	Carrier frequency setting	<table border="1" data-bbox="389 738 822 957"> <thead> <tr> <th>Carrier frequency</th> <th>Electromagnetic noise</th> <th>Noise and leakage current</th> <th>Heating eliminating</th> </tr> </thead> <tbody> <tr> <td>1kHz</td> <td>↑ High</td> <td>↑ Low</td> <td>↑ Low</td> </tr> <tr> <td>10kHz</td> <td>↕</td> <td>↕</td> <td>↕</td> </tr> <tr> <td>15kHz</td> <td>↓ Low</td> <td>↓ High</td> <td>↓ High</td> </tr> </tbody> </table> <p>Relationship between models and carrier frequencies</p> <table border="1" data-bbox="389 1050 822 1414"> <thead> <tr> <th colspan="2">Model</th> <th>The factory value of carrier frequency</th> </tr> </thead> <tbody> <tr> <td rowspan="3">380V</td> <td>1.5–11kW</td> <td>8kHz</td> </tr> <tr> <td>15–55kW</td> <td>4kHz</td> </tr> <tr> <td>Above 75kW</td> <td>2kHz</td> </tr> <tr> <td rowspan="3">500V</td> <td>4–11kW</td> <td>8kHz</td> </tr> <tr> <td>15–55kW</td> <td>4kHz</td> </tr> <tr> <td>Above 75kW</td> <td>2kHz</td> </tr> <tr> <td>660V</td> <td>22–55kW</td> <td>4kHz</td> </tr> </tbody> </table>	Carrier frequency	Electromagnetic noise	Noise and leakage current	Heating eliminating	1kHz	↑ High	↑ Low	↑ Low	10kHz	↕	↕	↕	15kHz	↓ Low	↓ High	↓ High	Model		The factory value of carrier frequency	380V	1.5–11kW	8kHz	15–55kW	4kHz	Above 75kW	2kHz	500V	4–11kW	8kHz	15–55kW	4kHz	Above 75kW	2kHz	660V	22–55kW	4kHz	Depend on model	○
Carrier frequency	Electromagnetic noise	Noise and leakage current	Heating eliminating																																					
1kHz	↑ High	↑ Low	↑ Low																																					
10kHz	↕	↕	↕																																					
15kHz	↓ Low	↓ High	↓ High																																					
Model		The factory value of carrier frequency																																						
380V	1.5–11kW	8kHz																																						
	15–55kW	4kHz																																						
	Above 75kW	2kHz																																						
500V	4–11kW	8kHz																																						
	15–55kW	4kHz																																						
	Above 75kW	2kHz																																						
660V	22–55kW	4kHz																																						

Function code	Name	Detailed instruction of parameters		Default value	Modify	
			Above 75kW	2kHz		
		<p>The advantage of high carrier frequency: ideal current waveform, little current harmonic wave and motor noise.</p> <p>The disadvantage of high carrier frequency: increasing the switch loss, increasing VFD temperature and the impact to the output capacity. The VFD needs to derate on high carrier frequency. At the same time, the leakage and electrical magnetic interference will increase.</p> <p>Applying low carrier frequency is contrary to the above, too low carrier frequency will cause unstable running, torque decreasing and surge.</p> <p>The manufacturer has set a reasonable carrier frequency when the VFD is in factory. In general, users do not need to change the parameter.</p> <p>When the frequency used exceeds the default carrier frequency, the VFD needs to derate 10% for each additional 1k carrier frequency.</p> <p>Setting range: 1.0–15.0kHz</p>				
P00.15	Motor parameter autotuning	<p>0: No operation</p> <p>1: Rotating autotuning</p> <p>Comprehensive motor parameter autotune</p> <p>It is recommended to use rotating autotuning when high control accuracy is needed.</p> <p>2: Static autotuning 1 (autotune totally); It is suitable in the cases when the motor cannot de-couple from the load. The autotuning for the motor parameter will impact the control accuracy.</p> <p>3: Static autotuning 2 (autotune part parameters); when the current motor is motor 1, autotune P02.06, P02.07, P02.08; and when the current motor is motor 2, autotune P12.06, P12.07, P12.08.</p>		0	☉	
P00.16	AVR function selection	<p>0: Invalid</p> <p>1: Valid during the whole procedure</p> <p>The auto-adjusting function of the VFD can cancel the impact on the output voltage of the</p>		1	○	

Function code	Name	Detailed instruction of parameters	Default value	Modify
		VFD because of the bus voltage fluctuation.		
P00.17	Reserved	Reserved	0	⊙
P00.18	Function restore parameter	<p>0: No operation 1: Restore the default value 2: Cancel the fault record</p> <p>Note: The function code will restore to 0 after finishing the operation of the selected function code. Restoring to the default value will cancel the user password, please use this function with caution.</p>	0	⊙
P01 Group Start-up and stop control				
P01.00	Start mode	<p>0: Start-up directly:start from the starting frequency P01.01 1: Start-up after DC braking: start the motor from the starting frequency after DC braking (set the parameter P01.03 and P01.04). It is suitable in the cases where reverse rotation may occur to the low inertia load during starting. 2: Start-up after speed tracing: start the rotating motor smoothly after tracking the rotation speed and direction automatically. It is suitable in the cases where reverse rotation may occur to the big inertia load during starting.</p> <p>Note: This function is provided for VFDs of 4kW or above.</p>	0	⊙
P01.01	Starting frequency of direct start	<p>Starting frequency of direct start-up means the original frequency during the VFD starting. See P01.02 for detailed information. Setting range: 0.00–50.00Hz</p>	0.50Hz	⊙
P01.02	Retention time of the starting frequency	<p>Set a proper starting frequency to increase the torque of the VFD during starting. During the retention time of the starting frequency, the output frequency of the VFD is the starting frequency. And then, the VFD will run from the starting frequency to the set frequency. If the set frequency is lower than the starting frequency, the VFD will stop running and keep in the stand-by</p>	0.0s	⊙

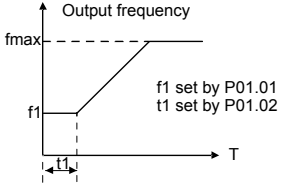
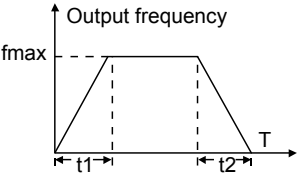
Function code	Name	Detailed instruction of parameters	Default value	Modify
		<p>state. The starting frequency is not limited in the lower limit frequency.</p>  <p>Setting range: 0.0–50.0s</p>		
P01.03	The braking current before starting	<p>The VFD will carry out DC braking at the braking current set before starting and it will speed up after the DC braking time. If the DC braking time is set to 0, the DC braking is invalid.</p> <p>The stronger the braking current, the bigger the braking power. The DC braking current before starting means the percentage of the rated current of the VFD.</p> <p>Setting range of P01.03: 0.0–100.0% Setting range of P01.04: 0.00–50.00s</p>	0.0%	⊙
P01.04	The braking time before starting		0.00s	⊙
P01.05	ACC/DEC selection	<p>The changing mode of the frequency during start-up and running.</p> <p>0: Linear type The output frequency increases or decreases linearly.</p>  <p>1: Reserved</p>	0	⊙
P01.06	Reserved		Reserved	⊙
P01.07	Reserved		Reserved	⊙
P01.08	Stop mode	<p>0: Decelerate to stop: after the stop command becomes valid, the VFD decelerates to decrease the output frequency during the set time. When the frequency decreases to P01.15, the VFD stops.</p>	0	○

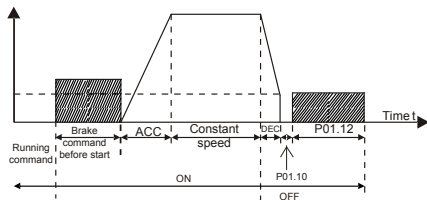
Function code	Name	Detailed instruction of parameters	Default value	Modify
		1: Coast to stop: after the stop command becomes valid, the VFD ceases the output immediately. And the load coasts to stop at the mechanical inertia.		
P01.09	Starting frequency of DC braking	The starting frequency of stop braking: the VFD will carry on stop DC braking when the frequency is arrived during the procedure of decelerating to stop.	0.00Hz	<input type="radio"/>
P01.10	Waiting time of DC braking	The waiting time of stop braking: before the stop DC braking, the VFD will close output and begin to carry on the DC braking after the waiting time.	0.00s	<input type="radio"/>
P01.11	DC braking current	This function is used to avoid the overcurrent fault caused by DC braking when the speed is too high. Stop DC braking current: the DC brake added. The stronger the current, the bigger the DC braking effect.	0.0%	<input type="radio"/>
P01.12	DC braking time	The braking time of stop braking: the retention time of DC brake. If the time is 0, the DC brake is invalid. The VFD will stop at the set deceleration time.  Setting range of P01.09: 0.00Hz–P00.03 Setting range of P01.10: 0.00–50.00s Setting range of P01.11: 0.0–100.0% Setting range of P01.12: 0.00–50.00s	0.00s	<input type="radio"/>
P01.13	Dead time of FWD/REV rotation	During the procedure of switching for/rev rotation, set the threshold by P01.14, which is as the table below:	0.0s	<input type="radio"/>

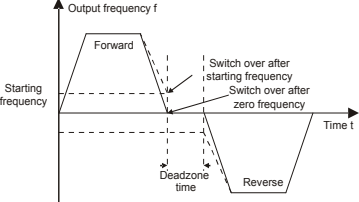
Function code	Name	Detailed instruction of parameters	Default value	Modify
		 <p>Setting range: 0.0–3600.0s</p>		
P01.14	Shifting between FWD/REV rotation	Set the threshold point of the VFD: 0: Switch after zero frequency 1: Switch after the starting frequency 2: Switch after the speed reach P01.15 and delay for P01.24	0	☉
P01.15	Stopping speed	0.00–100.00Hz	0.50 Hz	☉
P01.16	Detection of stopping speed	0: Detect according to speed setting (no stopping delay) 1: Detect according to speed feedback (only valid for vector control)	1	☉
P01.17	Detection time of the feedback speed	If set P01.16 to 1, the feedback frequency is less than or equal to P01.15 and detect in the set time of P01.17, the VFD will stop; otherwise the VFD will stop after the set time of P01.17.	0.50s	☉
P01.18	Terminal running protection when powering on	When the running commands are controlled by the terminal, the system will detect the state of the running terminal during powering on. 0: The terminal running command is invalid when powering on. Even the running command is detected to be valid during powering on, the VFD	0	○

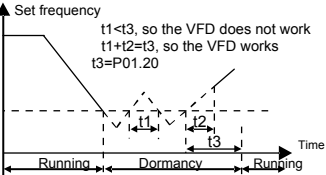
Function code	Name	Detailed instruction of parameters	Default value	Modify
		<p>won't run and the system keeps in the protection state until the running command is canceled and enabled again.</p> <p>1: The terminal running command is valid when powering on. If the running command is detected to be valid during powering on, the system will start the VFD automatically after the initialization.</p> <p>Note: this function should be selected with cautions, or serious result may follow.</p>		
P01.19	Action if running frequency < lower limit frequency (valid >0)	<p>This function code determines the running state of the VFD when the set frequency is lower than the lower-limit one.</p> <p>0: Run at the lower-limit frequency 1: Stop 2: Hibernation</p> <p>The VFD will coast to stop when the set frequency is lower than the lower-limit one. If the set frequency is above the lower limit one again and it lasts for the time set by P01.20, the VFD will come back to the running state automatically.</p>	0	☉
P01.20	Hibernation restore delay time	<p>This function code determines the hibernation delay time. When the running frequency of the VFD is lower than the lower limit one, the VFD will pause to stand by.</p> <p>When the set frequency is above the lower limit one again and it lasts for the time set by P01.20, the VFD will run automatically.</p> <p>Note: The time is the total value when the set frequency is above the lower limit one.</p>  <p>Setting range: 0.0–3600.0s (valid when P01.19=2)</p>	0.0s	○
P01.21	Restart after	This function can enable the VFD start or not after	0	○

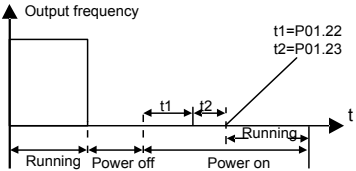
Function code	Name	Detailed instruction of parameters	Default value	Modify
	power outage	the power off and then power on. 0: Ddisable 1: Enable, if the starting need is met, the VFD will run automatically after waiting for the time defined by P01.22.		
P01.22	Waiting time of restart after power outage	The function determines the waiting time before the automatic running of the VFD when powering off and then powering on.  Setting range: 0.0–3600.0s (valid when P01.21=1)	1.0s	○
P01.23	Start delay time	The function determines the brake release after the running command is given, and the VFD is in a stand-by state and wait for the delay time set by P01.23 Setting range: 0.0–60.0s	0.0s	○
P01.24	Delay time of the stop speed	Setting range: 0.0–100.0 s	0.0s	○
P01.25	0Hz output selection	Select the output mode at 0Hz. 0: Output without voltage 1: Output with voltage 2: Output at DC braking current at stopping	0	○
P02 Group Motor 1				
P02.00	Motor type 1	0: Asynchronous motor 1: Synchronous motor Note: Switch the current motor by the switching channel of P08.31.	0	◎
P02.01	Rated power of asynchronous motor 1	0.1–3000.0kW Set the parameters of the controlled AM. In order to ensure control performance, set	Depend on model	◎

Function code	Name	Detailed instruction of parameters		Default value	Modify
P02.02	Rated frequency of asynchronous motor 1	0.01Hz–P00.03 (Max. output frequency)	the value of P02.01–P02.05 based on the nameplate parameters.	50.00 Hz	☉
P02.03	Rated speed of asynchronous motor 1	1–3600rpm	Goodrive35 series VFD provides parameter autotuning function. The accurate parameter autotuning requires proper parameter setup. In order to ensure control performance, configure the motor based on the motor which matches with the VFD. If the gap between motor power and the matched motor is too large, the control performance of the VFD will be deteriorated greatly. Note: P02.02–P02.10 can be initialized by resetting rated motor power P02.01.	Depend on model	☉
P02.04	Rated voltage of asynchronous motor 1	0–1200V		Depend on model	☉
P02.05	Rated current of asynchronous motor 1	0.8–6000.0A		Depend on model	☉
P02.06	Stator resistor of asynchronous motor 1	0.001–65.535Ω	After motor parameter autotuning finishes, the setting value of P02.06–P02.10 will be updated automatically. These parameters are the basic parameters for high-performance vector control, which will impact the control performance directly. Note: Users cannot	Depend on model	○
P02.07	Rotor resistor of asynchronous motor 1	0.001–65.535Ω		Depend on model	○
P02.08	Leakage inductance of asynchronous motor 1	0.1–6553.5 mH		Depend on model	○

Function code	Name	Detailed instruction of parameters		Default value	Modify
P02.09	Mutual inductance of asynchronous motor 1	0.1–6553.5 mH	change this group of parameters at will.	Depend on model	<input type="radio"/>
P02.10	Non-load current of asynchronous motor 1	0.1–6553.5A		Depend on model	<input type="radio"/>
P02.11	Magnetic saturation coefficient 1 for the iron core of AM1	0.0–100.0%		80.0%	<input checked="" type="radio"/>
P02.12	Magnetic saturation coefficient 2 for the iron core of AM1	0.0–100.0%		68.0%	<input checked="" type="radio"/>
P02.13	Magnetic saturation coefficient 3 for the iron core of AM1	0.0–100.0%		57.0%	<input checked="" type="radio"/>
P02.14	Magnetic saturation coefficient 4 for the iron core of AM1	0.0–100.0%		40.0%	<input checked="" type="radio"/>
P02.15	Rated power of synchronous motor 1	0.1–3000.0kW	Set the parameters of the controlled synchronous motor (SM). To ensure the control performance, se the values of P02.15 to P02.19 properly according to the parameters on the name plate of the SM.	Depend on model	<input checked="" type="radio"/>
P02.16	Rated frequency of synchronous motor 1	0.01Hz–P00.03 (Max. frequency)		50.00 Hz	<input checked="" type="radio"/>

Function code	Name	Detailed instruction of parameters		Default value	Modify
P02.17	Number of poles pairs for synchronous motor 1	1–50	<p>Goodrive300 VFDs provide the parameter autotuning function. Correct parameter autotuning depends on the correct setting of the name plate parameters of the motor. To ensure the control performance, configure the standard matched motor for the VFD. If the power of the motor configured is greatly different from that of the standard matched one, the control performance of the VFD degrades significantly.</p> <p>Note: P02.16 to P02.19 may be initialized by resetting the rated power of the motor (P02.15).</p> <p>After the motor parameter autotuning is properly complete, the values of P02.20 to P02.22 are updated automatically. These parameters are the benchmark parameters of high-performance vector control, directly affecting the control performance. When P00.15=1 (rotating autotuning), the set value of P02.23 may be automatically updated by autotuning. In this case, there is no need to change the value of P02.23. When P00.15=2 (static autotuning), the set value of P02.23 cannot be updated by</p>	2	☉
P02.18	Rated voltage of synchronous motor 1	0–1200V		Depend on model	☉
P02.19	Rated current of synchronous motor 1	0.8–6000.0A		Depend on model	☉
P02.20	Stator resistor of synchronous motor 1	0.001–65.535Ω		Depend on model	○
P02.21	Direct axis inductance of synchronous motor 1	0.01–655.35mH		Depend on model	○
P02.22	Quadrature axis inductance of synchronous motor 1	0.01–655.35mH		Depend on model	○
P02.23	Back EMF constant of synchronous motor 1	When P00.15=2, the set value of P02.23 cannot be updated by autotuning, please count		300	○

Function code	Name	Detailed instruction of parameters		Default value	Modify
		<p>according to the following method.</p> <p>The counter-electromotive force constant can be counted according to the parameters on the name plate of the motor. There are three ways to count:</p> <p>1. If the name plate designate the counter-electromotive force constant K_e, then:</p> $E = (K_e \times n_N \times 2\pi) / 60$ <p>2. If the name plate designate the counter-electromotive force constant E' (V/1000r/min), then:</p> $E = E' \times n_N / 1000$ <p>3. If the name plate does not designate the above parameters,</p>	<p>autotuning. In this case, calculate and manually change the value of P02.23.</p>		

Function code	Name	Detailed instruction of parameters		Default value	Modify
		then: $E=P/\sqrt{3}\times I$ In the above formulas: n_N is the rated rotation speed, P is the rated power and I is the rated current. Setting range: 0–10000			
P02.24	Initial pole position of synchronous motor 1 (reserved)	0x0000–0xFFFF		0	●
P02.25	Identification current of synchronous motor 1 (reserved)	0%–50% (rated current of the motor)		10%	●
P02.26	Motor 1 overload protection	0: No protection 1: Common motor (with low speed compensation). Because the heat-releasing effect of the common motors will be weakened, the corresponding electric heat protection will be adjusted properly. The low speed compensation characteristic mentioned here means reducing the threshold of the overload protection of the motor whose running frequency is below 30Hz. 2: Variable frequency motor (without low speed compensation) Because the heat-releasing effect of the specific motors won't be impacted by the rotation speed, it is not necessary to adjust the protection value during low-speed running.		2	◎
P02.27	Motor 1 overload	Times of motor overload $M = I_{out}/(I_n \times K)$ In is the rated current of the motor, Iout is the		100.0%	○

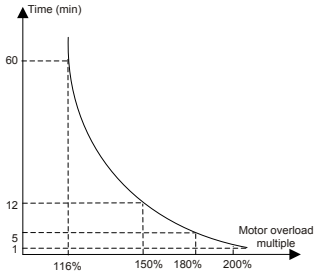
Function code	Name	Detailed instruction of parameters	Default value	Modify
	protection coefficient	<p>output current of the VFD and K is the motor protection coefficient.</p> <p>The smaller K is, the greater M is, and the more likely protection is implemented.</p> <p>When M=116%, protection is performed after motor overload lasts for 1 hour; when M=150%, protection is performed after motor overload lasts for 12 minutes; when M=180%, protection is performed after motor overload lasts for 5 minutes; when M=200%, protection is performed after motor overload lasts for 60 seconds; and when $M \geq 400\%$, protection is performed immediately.</p>  <p>Setting range: 20.0%–120.0%</p>		
P02.28	Correction coefficient of motor 1 power	<p>Correct the power displaying of motor 1.</p> <p>Only impact the displaying value other than the control performance of the VFD.</p> <p>Setting range: 0.00–3.00</p>	1.00	●
P02.29	Parameter display of motor 1	<p>0: Display according to the motor type</p> <p>1: Display all</p>	0	●
P03 Group Vector control				
P03.00	Speed loop proportional gain 1	<p>The parameters P03.00–P03.05 only apply to vector control mode. Below the switching frequency 1 (P03.02), the speed loop PI parameters are: P03.00 and P03.01. Above the switching frequency 2 (P03.05), the speed loop PI</p>	20.0	○
P03.01	Speed loop integral time 1		0.200s	○

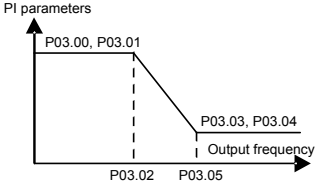
Function code	Name	Detailed instruction of parameters	Default value	Modify
P03.02	Low switching frequency	parameters are: P03.03 and P03.04. PI parameters are gained according to the linear change of two groups of parameters. It is shown as below: 	5.00Hz	<input type="radio"/>
P03.03	Speed loop proportional gain 2		20.0	<input type="radio"/>
P03.04	Speed loop integral time 2		0.200s	<input type="radio"/>
P03.05	High switching frequency	Setting the proportional coefficient and integral time of the adjustor can change the dynamic response performance of vector control speed loop. Increasing the proportional gain and decreasing the integral time can speed up the dynamic response of the speed loop. But too high proportional gain and too low integral time may cause system vibration and overshoot. Too low proportional gain may cause system vibration and speed static deviation. PI has a close relationship with the inertia of the system. Adjust on the base of PI according to different loads to meet various demands. Setting range of P03.00: 0–200.0 Setting range of P03.01: 0.000–10.000s Setting range of P03.02: 0.00Hz–P03.05 Setting range of P03.03: 0–200.0 Setting range of P03.04: 0.000–10.000s Setting range of P03.05: P03.02–P00.03 (Max. output frequency)	10.00 Hz	<input type="radio"/>
P03.06	Speed loop output filter	0–8 (corresponds to $0-2^8/10\text{ms}$)	0	<input type="radio"/>
P03.07	Compensation coefficient of electromotion slip	Slip compensation coefficient is used to adjust the slip frequency of the vector control and improve the speed control accuracy of the system. Adjusting the parameter properly can control the speed steady-state error. Setting range: 50%–200%	100%	<input type="radio"/>
P03.08	Compensation		100%	<input type="radio"/>

Function code	Name	Detailed instruction of parameters	Default value	Modify
	coefficient of braking slip			
P03.09	Current loop percentage coefficient P	Note: 1 These two parameters adjust the PI adjustment parameter of the current loop which affects the dynamic response speed and control accuracy directly. Generally, users do not need to change the default value. 2 Only apply to the vector control mode without PG 0 (P00.00=0). Setting range: 0–65535	1000	<input type="radio"/>
P03.10	Current loop integral coefficient 1		1000	<input type="radio"/>
P03.11	Torque setting method	This parameter is used to enable the torque control mode, and set the torque. 0: Torque control is invalid 1: Keypad setting torque (P03.12) 2: Analog AI1 setting torque 3: Analog AI2 setting torque 4: Analog AI3 setting torque 5: Pulse frequency HDI setting torque 6: Multi-step torque setting 7: Modbus communication setting torque 8: PROFIBUS\CANopen communication setting torque 9: Ethernet communication setting torque 10: Reserved Note: For setting modes of 2–10, 100% corresponds to three times of the rated current of the motor.	0	<input type="radio"/>
P03.12	Keypad setting torque	Setting range: -300.0%–300.0% (rated current of the motor)	50.0%	<input type="radio"/>
P03.13	Torque reference filter time	0.000–10.000s	0.010s	<input type="radio"/>
P03.14	Upper frequency of forward rotation in	0: Keypad (P03.16 sets P03.14, P03.17 sets P03.15) 1: AI1	0	<input type="radio"/>

Function code	Name	Detailed instruction of parameters	Default value	Modify
	vector control	2: AI2		
P03.15	Upper frequency of reverse rotation in vector control	3: AI3 4: Pulse frequency HDI setting upper-limit frequency 5: Multi-step setting upper-limit frequency 6: Modbus communication setting upper-limit frequency 7: PROFIBUS\CANopen communication setting upper-limit frequency 8: Ethernet communication setting upper-limit frequency 9: Reserved Note: For setting modes of 1–9, 100% corresponds to the maximum frequency.	0	○
P03.16	Keypad setting for upper frequency of forward rotation	This function is used to set the upper limit of the frequency. P03.16 sets the value of P03.14; P03.17 sets the value of P03.15.	50.00 Hz	○
P03.17	Keypad setting for upper frequency of reverse rotation	Setting range: 0.00 Hz–P00.03 (Max. output frequency)	50.00 Hz	○
P03.18	Upper electromotion torque source	This function code is used to select the electromotion and braking torque upper-limit setting source selection. 0: Keypad setting upper-limit frequency(P03.20 sets P03.18, P03.21 sets P03.19)	0	○
P03.19	Upper braking torque source	1: AI1 2: AI2 3: AI3	0	○

Function code	Name	Detailed instruction of parameters	Default value	Modify
		4: HDI 5: Modbus communication 6: PROFIBUS\CANopen communication 7: Ethernet communication 8: Reserved Note: For setting modes of 1–9, 100% corresponds to three times of the motor current.		
P03.20	Keypad setting of electromotion torque	The function code is used to set the limit of the torque. Setting range: 0.0–300.0% (motor rated current)	180.0%	<input type="radio"/>
P03.21	Keypad setting of braking torque		180.0%	<input type="radio"/>
P03.22	Weakening coefficient in constant power zone	The usage of motor in weakening control. 	0.3	<input type="radio"/>
P03.23	Lowest weakening point in constant power zone	Function code P03.22 and P03.23 are effective at constant power. The motor will enter into the weakening state when the motor runs at rated speed. Change the weakening curve by modifying the weakening control coefficient. The bigger the weakening control coefficient is, the steeper the weak curve is. Setting range of P03.22: 0.1–2.0 Setting range of P03.23: 10%–100%	20%	<input type="radio"/>
P03.24	Max. voltage limit	P03.24 set the Max. Voltage of the VFD, which is dependent on the site situation. Setting range: 0.0–120.0%	100.0%	<input checked="" type="radio"/>
P03.25	Pre-exciting	Preactivate the motor when the VFD starts up.	0.300s	<input type="radio"/>

Function code	Name	Detailed instruction of parameters	Default value	Modify
	time	Build up a magnetic field inside the VFD to improve the torque performance during the starting process. The setting time: 0.000–10.000s		
P03.26	Weak magnetic proportional gain	0–8000 Note: P03.24–P03.26 are invalid for the vector mode.	1000	○
P03.27	Vector control speed	0: Display the actual value 1: Display the setting value	0	○
P03.28	Compensation coefficient of static friction	0.0–100.0% Adjust P03.28 to compensate the coefficient of static friction. Only valid when setting in 1Hz.	0.0%	○
P03.29	Compensation coefficient of dynamic friction	0.0–100.0% Adjust P03.29 to compensate the coefficient of static friction. Only valid when setting in 1Hz.	0.0%	○
P04 Group SVPWM control				
P04.00	Motor 1V/F curve setting	These function codes define the V/F curve of Goodrive300 motor 1 to meet the need of different loads. 0: Straight line V/F curve; applying to the constant torque load 1: Multi-dots V/F curve 2: 1.3 th power low torque V/F curve 3: 1.7 th power low torque V/F curve 4: 2.0 th power low torque V/F curve Curves 2–4 apply to the torque loads such as fans and water pumps. Users can adjust according to the features of the loads to achieve a best energy-consuming effect. 5: Customized V/F(V/F separation); on this mode, V and F can be separated from adjusted through the frequency given channel set by P00.06 or the voltage given channel set by P04.27 to change	0	◎

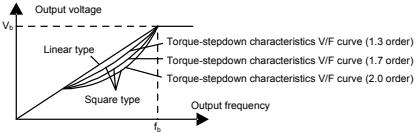
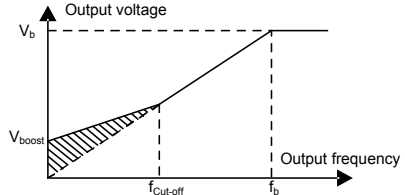
Function code	Name	Detailed instruction of parameters	Default value	Modify
		<p>the feature of the curve.</p> <p>Note: V_b in the below picture is the motor rated voltage and f_b is the motor rated frequency.</p> 		
P04.01	Torque boost of motor 1	<p>Boost compensation can be given to the output voltage for compensating the features of low frequency torque. P04.01 is for the Max. Output voltage V_b.</p>	0.0%	○
P04.02	Torque boost close of motor 1	<p>P04.02 defines the percentage of closing frequency of manual torque to f_b. Torque boost can improve the features of low frequency torque of V/F.</p> <p>Torque boost should be selected according to the load. The bigger the load is, the bigger the boost is. Too big torque boost is inappropriate because the motor will run with over-magnetic, and the current of the VFD will increase to raise the temperature of the VFD and decrease the efficiency.</p> <p>When the torque boost is set to 0.0%, the VFD is automatic torque boost.</p> <p>Torque boost threshold: under the threshold, the torque boost is valid, but over the threshold, the torque boost is invalid.</p>  <p>Setting range of P04.01: 0.0%: (automatic) 0.1%–10.0%</p> <p>Setting range of P04.02: 0.0%–50.0%</p>	20.0%	○
P04.03	V/F	When P04.00 =1, the user can set V//F curve	0.00Hz	○

Function code	Name	Detailed instruction of parameters	Default value	Modify
	frequency 1 of motor 1	through P04.03–P04.08. V/F is generally set according to the load of the motor.		
P04.04	V/F voltage 1 of motor 1	<p>Note: $V1 < V2 < V3$, $f1 < f2 < f3$. Too high low frequency voltage will heat the motor excessively or cause damage. The VFD may stall when overcurrent or overcurrent protection.</p>	00.0%	<input type="radio"/>
P04.05	V/F frequency 2 of motor 1		00.00 Hz	<input type="radio"/>
P04.06	V/F voltage 2 of motor 1		00.0%	<input type="radio"/>
P04.07	V/F frequency 3 of motor 1		00.00 Hz	<input type="radio"/>
P04.08	V/F voltage 3 of motor 1		<p>Setting range of P04.03: 0.00Hz–P04.05 Setting range of P04.04: 0.0%–110.0% Setting range of P04.05: P04.03– P04.07 Setting range of P04.06: 0.0%–110.0% (the rated voltage of motor 1) Setting range of P04.07: P04.05– P02.02 (the rated frequency of motor 1) or P04.05–P02.16 (the rated frequency of motor 1) Setting range of P04.08: 0.0%–110.0% (the rated voltage of motor 1)</p>	00.0%
P04.09	V/F slip compensation gain of motor 1	<p>This function code is used to compensate the change of the rotation speed caused by load during compensation SVPWM control to improve the rigidity of the motor. It can be set to the rated slip frequency of the motor which is counted as below:</p> $\Delta f = f_b - n \times p / 60$ <p>Of which, f_b is the rated frequency of the motor, its function code is P02.02; n is the rated rotating speed of the motor and its function code is P02.03; p is the pole pair of the motor. 100.0% corresponds to the rated slip frequency Δf. Setting range: 0.0–200.0%</p>	100.0%	<input type="radio"/>

Function code	Name	Detailed instruction of parameters	Default value	Modify
P04.10	Vibration control factor at low frequency of motor 1	In SVPWM control mode, current fluctuation may occur to the motor at some frequency, especially the motor with big power. The motor cannot run stably or overcurrent may occur. These phenomena can be canceled by adjusting this parameter. Setting range of P04.10: 0–100 Setting range of P04.11: 0–100 Setting range of P04.12: 0.00Hz–P00.03 (Max. frequency)	10	<input type="radio"/>
P04.11	Vibration control factor at high frequency of motor 1		10	<input type="radio"/>
P04.12	Vibration control threshold of motor 1		30.00 Hz	<input type="radio"/>
P04.13	Motor 2 V/F curve setting	This group of parameters defines the V/F setting modes of Goodrive300 motor 2 to meet various requirements of different loads. See P04.00–P04.12 for the detailed function code instruction. Note: P04 group includes two sets of V/F parameters of the motor which cannot display simultaneously. Only the selected V/F parameter can be shown. The motor selection can be defined by terminals function "the shift between motor 1 and motor 2".	0	<input checked="" type="radio"/>
P04.14	Torque boost of motor 2		0.0%	<input type="radio"/>
P04.15	Torque boost close of motor 2		20.0%	<input type="radio"/>
P04.16	V/F frequency 1 of motor 2		0.00Hz	<input type="radio"/>
P04.17	V/F voltage 1 of motor 2		00.0%	<input type="radio"/>
P04.18	V/F frequency 2 of motor 2		00.00 Hz	<input type="radio"/>
P04.19	V/F voltage 2 of motor 2		00.0%	<input type="radio"/>
P04.20	V/F frequency 3 of motor 2		00.00 Hz	<input type="radio"/>
P04.21	V/F		00.0%	<input type="radio"/>

Function code	Name	Detailed instruction of parameters	Default value	Modify
	voltage 3 of motor 2			
P04.22	V/F slip compensation gain of motor 2		100.0%	<input type="radio"/>
P04.23	Vibration control factor at low frequency of motor 2	In SVPWM control mode, current fluctuation may occur to the motor on some frequency, especially the motor with big power. The motor cannot run stably or overcurrent may occur. These phenomena can be canceled by adjusting this parameter. Setting range of P04.23: 0–100 Setting range of P04.24: 0–100 Setting range of P04.25: 0.00 Hz–P00.03 (Max. output frequency)	10	<input type="radio"/>
P04.24	Vibration control factor at high frequency of motor 2		10	<input type="radio"/>
P04.25	Vibration control threshold of motor 2		30.00 Hz	<input type="radio"/>
P04.26	Energy-saving operation	0: No operation 1: Automatic energy-saving operation Motors with light load will automatically adjust the output voltage to save energy.	0	<input checked="" type="radio"/>
P04.27	Voltage setting	Select the output setting channel at V/F curve separation. 0: Keypad: the output voltage is determined by P04.28. 1: AI1 2: AI2 3: AI3 4: HDI 5: Multi-step speed 6: PID 7: Modbus communication 8: PROFIBUS/CANopen communication 9: Ethernet communication	0	<input type="radio"/>

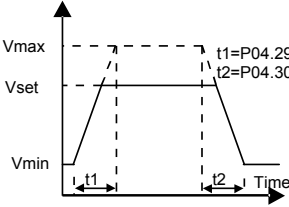
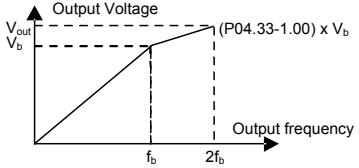
Function code	Name	Detailed instruction of parameters	Default value	Modify
		10: Reserved Note: 100% corresponds to the rated voltage of the motor.		
P04.28	Keypad setting voltage	The function code is the voltage displaying when the voltage is set through keypad. Setting range: 0.0%–100.0%	100.0%	○
P04.29	Voltage increasing time	Voltage increasing time is the time when the VFD accelerates from the output minimum voltage to the output maximum voltage.	5.0s	○
P04.30	Voltage decreasing time	Voltage decreasing time is the time when the VFD decelerates from the output maximum voltage to the output minimum voltage. Setting range: 0.0–3600.0s	5.0s	○
P04.31	Max. output voltage	Set the upper and low limit of the output voltage.	100.0%	◎
P04.32	Min. output voltage	 <p>Setting range of P04.31: P04.32–100.0%(the rated voltage of the motor) Setting range of P04.32: 0.0%– P04.31(the rated voltage of the motor)</p>	0.0%	◎
P04.33	Weaking coefficient at constant power	Used during field-weakening operation to adjust the output voltage of VFD in SVPWM mode. Note: Invalid in constant-torque mode.  <p>Setting range of P04.33: 1.00–1.30</p>	1.00	○
P05 Group Input terminals				
P05.00	HDI input selection	0: High pulse input. See P05.49–P05.54 1: Digital input. See P05.09.	0	◎

Function code	Name	Detailed instruction of parameters	Default value	Modify
P05.01	S1 terminals function selection	0: No function 1: Forward rotation operation 2: Reverse rotation operation	1	⊙
P05.02	S2 terminals function selection	3: 3-wire control operation 4: Forward jogging 5: Reverse jogging	4	⊙
P05.03	S3 terminals function selection	6: Coast to stop 7: Fault reset 8: Operation pause	7	⊙
P05.04	S4 terminals function selection	9: External fault input 10: Increasing frequency setting(UP) 11: Decreasing frequency setting(DOWN)	0	⊙
P05.05	S5 terminals function selection	12: Frequency setting clear 13: Shift between A setting and B setting 14: Shift between combination setting and A setting	0	⊙
P05.06	S6 terminals function selection	15: Shift between combination setting and B setting	0	⊙
P05.07	S7 terminals function selection	16: Multi-step speed terminal 1 17: Multi-step speed terminal 2 18: Multi-step speed terminal 3	0	⊙
P05.08	S8 terminals function selection	19: Multi- step speed terminal 4 20: Multi- step speed pause 21: ACC/DEC time 1	0	⊙
P05.09	HDI terminal function selection	22: ACC/DEC time 2 23: Simple PLC stop reset 24: Simple PLC pause 25: PID control pause 26: Traverse Pause (stop at the current frequency) 27: Traverse reset (return to the center frequency) 28: Counter reset 29: Torque control disabling 30: ACC/DEC disabling 31: Counter triggering 32: Length reset 33: Cancel the frequency change setting	0	⊙

Function code	Name	Detailed instruction of parameters	Default value	Modify																				
		temporarily 34: DC brake 35: Shift the motor 1 into motor 2 36: Shift the command to the keypad 37: Shift the command to the terminals 38: Shift the command to the communication 39: Pre-magnetized command 40: Consumption power clear 41: Consumption power holding 42–60: Reserved 61: PID pole switching 62–63: Reserved																						
P05.10	Polarity selection of the input terminals	The function code is used to set the polarity of the input terminals. Set the bit to 0, the input terminal is anode. Set the bit to 1, the input terminal is cathode. <table border="1" style="margin-left: 20px;"> <tr> <td>BIT0</td> <td>BIT1</td> <td>BIT2</td> <td>BIT3</td> <td>BIT4</td> </tr> <tr> <td>S1</td> <td>S2</td> <td>S3</td> <td>S4</td> <td>S5</td> </tr> <tr> <td>BIT5</td> <td>BIT6</td> <td>BIT7</td> <td>BIT8</td> <td></td> </tr> <tr> <td>S6</td> <td>S7</td> <td>S8</td> <td>HDI</td> <td></td> </tr> </table> Setting range: 0x000–0x1FF	BIT0	BIT1	BIT2	BIT3	BIT4	S1	S2	S3	S4	S5	BIT5	BIT6	BIT7	BIT8		S6	S7	S8	HDI		0x000	○
BIT0	BIT1	BIT2	BIT3	BIT4																				
S1	S2	S3	S4	S5																				
BIT5	BIT6	BIT7	BIT8																					
S6	S7	S8	HDI																					
P05.11	ON-OFF filter time	Set the sample filter time of S1–S8 and HDI terminals. If the interference is strong, increase the parameter to avoid the disoperation. 0.000–1.000s	0.010s	○																				
P05.12	Virtual terminals setting	0x000–0x1FF(0: Disabled, 1: Enabled) BIT0: S1 virtual terminal BIT1: S2 virtual terminal BIT2: S3 virtual terminal BIT3: S4 virtual terminal BIT4: S5 virtual terminal BIT5: S6 virtual terminal BIT6: S7 virtual terminal BIT7: S8 virtual terminal BIT8: HDI virtual terminal Note: After a virtual terminal is enabled, the state of the terminal can only be modified through	0x000	◎																				

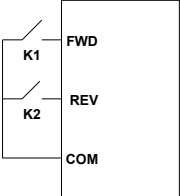
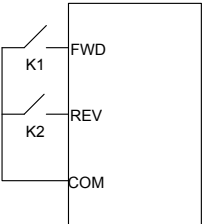
Function code	Name	Detailed instruction of parameters	Default value	Modify																														
		communication, and the communication address is 0x200A.																																
P05.13	Terminals control running mode	<p>Set the control operation mode of the terminals.</p> <p>0: 2-wire control 1; the enabling function and direction determination function are integrated. This mode is widely used. It determines the rotation direction by the defined FWD and REV terminals command.</p> <div style="display: flex; align-items: center;">  <table border="1" style="margin-left: 20px;"> <thead> <tr> <th>FWD</th> <th>REV</th> <th>Running command</th> </tr> </thead> <tbody> <tr> <td>OFF</td> <td>OFF</td> <td>Stop</td> </tr> <tr> <td>ON</td> <td>OFF</td> <td>Forward running</td> </tr> <tr> <td>OFF</td> <td>ON</td> <td>Reverse running</td> </tr> <tr> <td>ON</td> <td>ON</td> <td>Holding on</td> </tr> </tbody> </table> </div> <p>1: 2-wire control 2; the enabling function and the direction determination function are separated. In this mode, FWD is the enabling terminal, and the direction depends on the state of the defined REV.</p> <div style="display: flex; align-items: center;">  <table border="1" style="margin-left: 20px;"> <thead> <tr> <th>FWD</th> <th>REV</th> <th>Running command</th> </tr> </thead> <tbody> <tr> <td>OFF</td> <td>OFF</td> <td>Stop</td> </tr> <tr> <td>ON</td> <td>OFF</td> <td>Forward running</td> </tr> <tr> <td>OFF</td> <td>ON</td> <td>Stop</td> </tr> <tr> <td>ON</td> <td>ON</td> <td>Reverse running</td> </tr> </tbody> </table> </div> <p>2: 3-wire control 1; in this mode, SIn is the enabling terminal, and the running command is generated by FWD and the direction is controlled by REV. SIn must be in the closed state when the VFD is running. The FWD terminal generates a rising edge signal, and the VFD starts to run. The status of the REV terminal determines the running direction. When the VFD stops, the SIn terminal needs to be disconnected to complete the stopping.</p>	FWD	REV	Running command	OFF	OFF	Stop	ON	OFF	Forward running	OFF	ON	Reverse running	ON	ON	Holding on	FWD	REV	Running command	OFF	OFF	Stop	ON	OFF	Forward running	OFF	ON	Stop	ON	ON	Reverse running	0	©
FWD	REV	Running command																																
OFF	OFF	Stop																																
ON	OFF	Forward running																																
OFF	ON	Reverse running																																
ON	ON	Holding on																																
FWD	REV	Running command																																
OFF	OFF	Stop																																
ON	OFF	Forward running																																
OFF	ON	Stop																																
ON	ON	Reverse running																																

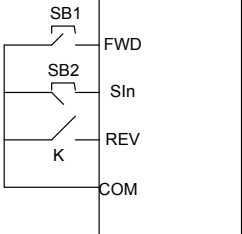
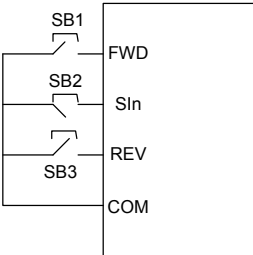
Function code	Name	Detailed instruction of parameters	Default value	Modify																					
		<div style="text-align: center;">  </div> <p>The direction control is as follows during operation:</p> <table border="1" data-bbox="385 528 826 794"> <thead> <tr> <th>SIn</th> <th>REV</th> <th>Previous direction</th> <th>Current direction</th> </tr> </thead> <tbody> <tr> <td rowspan="2">ON</td> <td rowspan="2">OFF→ON</td> <td>Forward</td> <td>Reverse</td> </tr> <tr> <td>Reverse</td> <td>Forward</td> </tr> <tr> <td rowspan="2">ON</td> <td rowspan="2">ON→OFF</td> <td>Reverse</td> <td>Forward</td> </tr> <tr> <td>Forward</td> <td>Reverse</td> </tr> <tr> <td rowspan="2">ON→OFF</td> <td>ON</td> <td colspan="2" rowspan="2">Decelerate to stop</td> </tr> <tr> <td>OFF</td> </tr> </tbody> </table> <p>SIn: 3-wire control; FWD: Forward running; REV: Reverse running</p> <p>3: 3-wire control mode 2. In this mode, SIn is defined as the enabling terminal, the running command is determined by the FWD or REV terminal, and the direction is determined by the FWD and REV terminals. When the VFD is running, terminal SIn must be in the connected state. Terminal FWD or REV generates a rising edge signal to run the VFD and determine its running direction. To stop the running of the VFD, you need to disconnect terminal SIn.</p> <div style="text-align: center;">  </div>	SIn	REV	Previous direction	Current direction	ON	OFF→ON	Forward	Reverse	Reverse	Forward	ON	ON→OFF	Reverse	Forward	Forward	Reverse	ON→OFF	ON	Decelerate to stop		OFF		
SIn	REV	Previous direction	Current direction																						
ON	OFF→ON	Forward	Reverse																						
		Reverse	Forward																						
ON	ON→OFF	Reverse	Forward																						
		Forward	Reverse																						
ON→OFF	ON	Decelerate to stop																							
	OFF																								

Function code	Name	Detailed instruction of parameters	Default value	Modify																						
		<table border="1"> <thead> <tr> <th>SIn</th> <th>FWD</th> <th>REV</th> <th>Direction</th> </tr> </thead> <tbody> <tr> <td rowspan="2">ON</td> <td rowspan="2">OFF→ON</td> <td>ON</td> <td>Forward</td> </tr> <tr> <td>OFF</td> <td>Reverse</td> </tr> <tr> <td rowspan="2">ON</td> <td>ON</td> <td rowspan="2">OFF→ON</td> <td>Forward</td> </tr> <tr> <td>OFF</td> <td>Reverse</td> </tr> <tr> <td rowspan="2">ON→OFF</td> <td></td> <td></td> <td rowspan="2">Decelerate to stop</td> </tr> <tr> <td></td> <td></td> </tr> </tbody> </table> <p>SIn: 3-wire operation control; FWD: Forward running; REV: Reverse running Note: For the 2-wire running mode, when the FWD/REV terminal is valid, and the VFD stops because of the stop command from other sources, the VFD won't work when the stopping command is canceled even the control terminal FWD/REV is still valid;. Only when FWD/REV is re-triggered, the VFD can start again. For example, the PLC single-cycle stop command, fixed-period stop command, and the STOP/RST stop command that is valid in terminal control mode (see P07.04).</p>	SIn	FWD	REV	Direction	ON	OFF→ON	ON	Forward	OFF	Reverse	ON	ON	OFF→ON	Forward	OFF	Reverse	ON→OFF			Decelerate to stop				
SIn	FWD	REV	Direction																							
ON	OFF→ON	ON	Forward																							
		OFF	Reverse																							
ON	ON	OFF→ON	Forward																							
	OFF		Reverse																							
ON→OFF			Decelerate to stop																							
P05.14	Switch-on delay of S1 terminal	<p>The function code defines the corresponding delay time of electrical level of the programmable terminals during switching on and switching off.</p> <p>Setting range: 0.000–50.000s</p>	0.000s	○																						
P05.15	Switch-off delay of S1 terminal		0.000s	○																						
P05.16	Switch-on delay of S2 terminal		0.000s	○																						
P05.17	Switch-off delay of S2 terminal		0.000s	○																						
P05.18	Switch-on delay of S3 terminal		0.000s	○																						

Function code	Name	Detailed instruction of parameters	Default value	Modify
P05.19	Switch-off delay of S3 terminal		0.000s	<input type="radio"/>
P05.20	Switch-on delay of S4 terminal		0.000s	<input type="radio"/>
P05.21	Switch-off delay of S4 terminal		0.000s	<input type="radio"/>
P05.22	Switch-on delay of S5 terminal		0.000s	<input type="radio"/>
P05.23	Switch-off delay of S5 terminal		0.000s	<input type="radio"/>
P05.24	Switch-on delay of S6 terminal		0.000s	<input type="radio"/>
P05.25	Switch-off delay of S6 terminal		0.000s	<input type="radio"/>
P05.26	Switch-on delay of S7 terminal		0.000s	<input type="radio"/>
P05.27	Switch-off delay of S7 terminal		0.000s	<input type="radio"/>
P05.28	Switch-on delay of S8 terminal		0.000s	<input type="radio"/>
P05.29	Switch-off delay of S8 terminal		0.000s	<input type="radio"/>
P05.30	Switch-on delay of HDI terminal		0.000s	<input type="radio"/>
P05.31	Switch-off		0.000s	<input type="radio"/>

Function code	Name	Detailed instruction of parameters	Default value	Modify
	delay of HDI terminal			
P05.32	Lower limit of AI1	<p>The function code defines the relationship between the analog input voltage and its corresponding set value. If the analog input voltage beyond the set minimum or maximum input value, the VFD will count at the minimum or maximum one.</p> <p>When the analog input is the current input, the corresponding voltage of 0–20 mA is 0–10V.</p> <p>In different cases, the corresponding rated value of 100.0% is different. See the application for detailed information.</p> <p>The figure below illustrates different applications:</p>	0.00V	<input type="radio"/>
P05.33	Corresponding setting of the lower limit of AI1		0.0%	<input type="radio"/>
P05.34	Upper limit of AI1		10.00V	<input type="radio"/>
P05.35	Corresponding setting of the upper limit of AI1		100.0%	<input type="radio"/>
P05.36	AI1 input filter time		0.100s	<input type="radio"/>
P05.37	Lower limit of AI2		0.00V	<input type="radio"/>
P05.38	Corresponding setting of the lower limit of AI2	0.0%	<input type="radio"/>	
P05.39	Upper limit of AI2	10.00V	<input type="radio"/>	
P05.40	Corresponding setting of the upper limit of AI2	100.0%	<input type="radio"/>	
P05.41	AI2 input filter time	<p>Note: Analog AI1 and AI2 can support 0–10V or 0–20mA input, when AI1 and AI2 selects 0–20mA input, the corresponding voltage of 20mA is 5V.</p>	0.100s	<input type="radio"/>
P05.42	Lower limit of AI3	AI3 can support the output of -10V–+10V.	-10.00V	<input type="radio"/>
P05.43	Corresponding setting of the lower limit of AI3	<p>Setting range of P05.32: 0.00V–P05.34</p> <p>Setting range of P05.33: -100.0%–100.0%</p> <p>Setting range of P05.34: P05.32–10.00V</p> <p>Setting range of P05.35: -100.0%–100.0%</p> <p>Setting range of P05.36: 0.000s–10.000s</p>	-100.0%	<input type="radio"/>
P05.44	Middle value		0.00V	<input type="radio"/>

Function code	Name	Detailed instruction of parameters	Default value	Modify
	of AI3	Setting range of P05.37: 0.00V–P05.39		
P05.45	Corresponding middle setting of AI3	Setting range of P05.38: -100.0%–100.0% Setting range of P05.39: P05.37–10.00V Setting range of P05.40: -100.0%–100.0%	0.0%	<input type="radio"/>
P05.46	Upper limit of AI3	Setting range of P05.41: 0.000s–10.000s Setting range of P05.42: -10.00V–P05.44	10.00V	<input type="radio"/>
P05.47	Corresponding setting of the upper limit of AI3	Setting range of P05.43: -100.0%–100.0% Setting range of P05.44: P05.42–P05.46 Setting range of P05.45: -100.0%–100.0% Setting range of P05.46: P05.44–10.00V	100.0%	<input type="radio"/>
P05.48	AI3 input filter time	Setting range of P05.47: -100.0%–100.0% Setting range of P05.48: 0.000s–10.000s	0.100s	<input type="radio"/>
P05.49	HDI high-speed pulse input function selection	The function selection when HDI terminals is high-speed pulse input 0: Frequency setting input, frequency setting source 1: Counter input, high-speed pulse counter input terminals 2: Length counting input, length counter input terminals	0	<input checked="" type="radio"/>
P05.50	Lower limit frequency of HDI	0.000kHz–P05.52	0.000 kHz	<input type="radio"/>
P05.51	Corresponding setting of HDI low frequency setting	-100.0%–100.0%	0.0%	<input type="radio"/>
P05.52	Upper limit frequency of HDI	P05.50–50.000kHz	50.000 kHz	<input type="radio"/>
P05.53	Corresponding setting of upper limit frequency of HDI	-100.0%–100.0%	100.0%	<input type="radio"/>
P05.54	HDI frequency input filter time	0.000s–10.000s	0.010s	<input type="radio"/>

Function code	Name	Detailed instruction of parameters	Default value	Modify
P06 Group Output terminals				
P06.00	HDO output	The function selection of the high-speed pulse output terminals. 0: Open collector high speed pulse output: The Max.pulse frequency is 50.0kHz. See P06.27–P06.31 for detailed information of the related functions. 1: Open collector output. See P06.02 for detailed information of the related functions.	0	☉
P06.01	Y1 output	0: Invalid	0	○
P06.02	HDO output	1: In operation	0	○
P06.03	Relay RO1 output	2: Forward rotation operation 3: Reverse rotation operation	1	○
P06.04	Relay RO2 output	4: Jogging operation 5: The VFD fault 6: Frequency degree test FDT1 7: Frequency degree test FDT2 8: Frequency arrival 9: Zero speed running 10: Upper limit frequency arrival 11: Lower limit frequency arrival 12: Ready for operation 13: Pre-magnetizing 14: Overload pre-alarm 15: Underload pre-alarm 16: Completion of simple PLC stage 17: Completion of simple PLC cycle 18: Set count value reached 19: Specified count value reached 20: External fault valid 21: Length arrival 22: Running time arrival 23: Modbus communication virtual terminals output 24: PROFIBUS/CANopen communication virtual terminals output 25: Ethernet communication virtual terminals	5	○

Function code	Name	Detailed instruction of parameters	Default value	Modify								
		output 26: Voltage establishment finished 27–30: Reserved										
P06.05	Polarity of output terminals	The function code is used to set the pole of the output terminal. When the current bit is set to 0, the input terminal is anode. When the current bit is set to 1, the input terminal is cathode. <table border="1" style="margin: 10px auto;"> <tr> <td>BIT0</td> <td>BIT1</td> <td>BIT2</td> <td>BIT3</td> </tr> <tr> <td>Y1</td> <td>HDO</td> <td>RO1</td> <td>RO2</td> </tr> </table> Setting range: 00–0F	BIT0	BIT1	BIT2	BIT3	Y1	HDO	RO1	RO2	00	○
BIT0	BIT1	BIT2	BIT3									
Y1	HDO	RO1	RO2									
P06.06	Y1 switch-on delay time		0.000s	○								
P06.07	Y1 switch-off delay time		0.000s	○								
P06.08	HDO switch-on delay time	The function code defines the corresponding delay time of the electrical level change during the programmable terminal switching on and off.	0.000s	○								
P06.09	HDO switch-off delay time		0.000s	○								
P06.10	RO1 switch-on delay time	Setting range: 0.000–50.000s	0.000s	○								
P06.11	RO1 switch-off delay time	Note: P06.08 and P06.08 are valid only when P06.00=1.	0.000s	○								
P06.12	RO2 switch-on delay time		0.000s	○								
P06.13	RO2 switch-off delay time		0.000s	○								
P06.14	AO1 output	0: Running frequency	0	○								
P06.15	AO2 output	1: Set frequency	0	○								
P06.16	HDO high-speed pulse output	2: Ramp reference frequency 3: Running rotation speed (relative to 2 times the synchronous rotation speed of the motor) 4: Output current (relative to 2 times the rated current of the VFD)	0	○								

Function code	Name	Detailed instruction of parameters	Default value	Modify
		5: Output current (relative to 2 times the rated current of the motor) 6: Output voltage (relative to 1.5 times the rated voltage of the VFD) 7: Output power (relative to 2 times the rated power of the motor) 8: Set torque value (relative to 2 times the rated torque of the motor) 9: Output torque (relative to 2 times the rated torque of the motor) 10: Analog AI1 input value 11: Analog AI2 input value 12: Analog AI3 input value 13: Input value of high-speed pulse HDI 14: Modbus communication set value 1 15: Modbus communication set value 2 16: Set value 1 of PROFIBUS/CANopen communication 17: Set value 2 of PROFIBUS/CANopen communication 18: Set value 1 of Ethernet communication 19: Set value 2 of Ethernet communication 20–21: Reserved 22: Torque current (corresponding to triple the rated current of the motor) 23: Ramp reference frequency (with sign) 24–30: Reserved		
P06.17	Lower output limit of AO1	The above function codes define the relative relationship between the output value and analog output. When the output value exceeds the range of set maximum or minimum output, it will count according to the low-limit or upper-limit output. When the analog output is current output, 1mA equals to 0.5V. In different cases, the corresponding analog output of 100% of the output value is different. See each application for detailed information.	0.0%	<input type="radio"/>
P06.18	Corresponding AO1 output of lower limit		0.00V	<input type="radio"/>
P06.19	Upper output limit of AO1		100.0%	<input type="radio"/>
P06.20	The corresponding AO1 output of upper limit		10.00V	<input type="radio"/>

Function code	Name	Detailed instruction of parameters	Default value	Modify	
P06.21	AO1 output filter time		0.000s	<input type="radio"/>	
P06.22	Lower output limit of AO2		0.0%	<input type="radio"/>	
P06.23	Corresponding AO2 output of lower limit		0.00V	<input type="radio"/>	
P06.24	Upper output limit of AO2		Setting range of P06.17: -100.0%~P06.19 Setting range of P06.18: 0.00V~10.00V	100.0%	<input type="radio"/>
P06.25	The corresponding AO2 output of upper limit		Setting range of P06.19: P06.17~100.0% Setting range of P06.20: 0.00V~10.00V Setting range of P06.21: 0.000s~10.000s Setting range of P06.22: -100.0%~P06.24	10.00V	<input type="radio"/>
P06.26	AO2 output filter time		Setting range of P06.23: 0.00V~10.00V Setting range of P06.24: P06.22~100.0%	0.000s	<input type="radio"/>
P06.27	Lower output limit of HDO		Setting range of P06.25: 0.00V~10.00V Setting range of P06.26: 0.000s~10.000s	0.0%	<input type="radio"/>
P06.28	Corresponding HDO output of lower limit		Setting range of P06.27: -100.0%~P06.29 Setting range of P06.28: 0.0~50.00kHz Setting range of P06.29: P06.27~100.0%	0.00kHz	<input type="radio"/>
P06.29	Upper output limit of HDO		Setting range of P06.30: 0.0~50.00kHz Setting range of P06.31: 0.000s~10.000s	100.0%	<input type="radio"/>
P06.30	Corresponding HDO output of upper limit			50.00kHz	<input type="radio"/>
P06.31	HDO output filter time		0.000s	<input type="radio"/>	
P07 Group Human-Machine Interface					
P07.00	User's password	0~65535 The password protection will be valid when setting any non-zero number. 00000: Clear the previous user's password, and make the password protection invalid. After the set user's password becomes valid, if the password is incorrect, users cannot enter the parameter menu. Only correct password can make the user check or modify the parameters.	0	<input type="radio"/>	

Function code	Name	Detailed instruction of parameters	Default value	Modify
		<p>Please remember all users' passwords.</p> <p>Retreat editing state of the function codes and the password protection will become valid in minute.</p> <p>If the valid password is available, press PRG/ESC to enter into the editing state of the function codes, and then "0.0.0.0.0" will be displayed. Unless input right password, the operator cannot enter into it.</p> <p>Note: Restoring to the default value can clear the password, use it with caution.</p>		
P07.01	Parameter copy	<p>The function code determines the manner of parameters copy.</p> <p>0: No operation</p> <p>1: Upload the local function parameter to the keypad</p> <p>2: Download the keypad function parameter to local address (including the motor parameters)</p> <p>3: Download the keypad function parameter to local address (excluding the motor parameter of P02 and P12 group)</p> <p>4: Download the keypad function parameters to local address (only for the motor parameter of P02 and P12 group)</p> <p>Note: After completing the 1–4 operations, the parameter will come back to 0 automatically; the function of upload and download excludes the factory parameters of P29.</p>	0	⊙
P07.02	QUICK/JOG function selection	<p>0: No function</p> <p>1: Jogging. Press QUICK/JOG to begin the jogging running.</p> <p>2: Shift the display state by the shifting key. Press QUICK/JOG to shift the displayed function code from right to left.</p> <p>3: Shift between forward rotations and reverse rotations. Press QUICK/JOG to shift the direction of the frequency commands. This function is only valid in the keypad commands channels.</p> <p>4: Clear UP/DOWN settings. Press QUICK/JOG</p>	1	⊙

Function code	Name	Detailed instruction of parameters	Default value	Modify
		<p>to clear the set value of UP/DOWN.</p> <p>5: Coast to stop. Press QUICK/JOG to coast to stop.</p> <p>6: Shift the given manner of running commands. Press QUICK/JOG to shift the given manner of running commands.</p> <p>7: Quick commission mode (committee according to the non-factory parameter)</p> <p>Note: Press QUICK/JOG to shift between forward rotation and reverse rotation, the VFD does not remember the state after shifting during powering off. The VFD will run in the running direction set according to parameter P00.13 during next powering on.</p>		
P07.03	Shifting sequence selection of QUICK/JOG commands	<p>When P07.02=6, set the shifting sequence of running command channels.</p> <p>0: Keypad control→terminals control→communication control</p> <p>1: Keypad control←→terminals control</p> <p>2: Keypad control←→communication control</p> <p>3: Terminals control←→communication control</p>	0	<input type="radio"/>
P07.04	STOP/RST stop function	<p>STOP/RST is valid for stop function. STOP/RST is valid in any state for the fault reset.</p> <p>0: Only valid for the keypad control</p> <p>1: Both valid for keypad and terminals control</p> <p>2: Both valid for keypad and communication control</p> <p>3: Valid for all control modes</p>	0	<input type="radio"/>
P07.05	Parameters state 1	<p>0x0000–0xFFFF</p> <p>BIT0: running frequency (Hz on)</p> <p>BIT1: set frequency (Hz flickering)</p> <p>BIT2: bus voltage (Hz on)</p> <p>BIT3: output voltage (V on)</p> <p>BIT4: output current (A on)</p> <p>BIT5: running rotation speed (rpm on)</p> <p>BIT6: output power (% on)</p> <p>BIT7: output torque (% on)</p> <p>BIT8: PID reference (% flickering)</p>	0x03FF	<input type="radio"/>

Function code	Name	Detailed instruction of parameters	Default value	Modify
		BIT9: PID feedback value (% on) BIT10: input terminals state BIT11: output terminals state BIT12: torque set value (% on) BIT13: pulse counter value BIT14: length value BIT15: PLC and the current stage in multi-step speed		
P07.06	Parameters state 2	0x0000–0xFFFF BIT0: AI1 (V on) BIT1: AI2 (V on) BIT2: AI3 (V on) BIT3: HDI frequency BIT4: motor overload percentage (% on) BIT5: the VFD overload percentage (% on) BIT6: ramp frequency given value (Hz on) BIT7: linear speed BIT8: AC inlet current (A on) BIT9: upper limit frequency (Hz on) BIT10–15: reserved	0x0000	○
P07.07	Parameters for stopping state	0x0000–0xFFFF BIT0: set frequency (Hz on, frequency flickering slowly) BIT1: bus voltage (V on) BIT2: input terminals state BIT3: output terminals state BIT4: PID reference (% flickering) BIT5: PID feedback value (% on) BIT6: torque reference (% on) BIT7: AI1 (V on) BIT8: AI2 (V on) BIT9: AI3 (V on) BIT10: HDI frequency BIT11: PLC and the current stage in multi-step speed BIT12: pulse counters BIT13: length value BIT14: upper limit frequency (Hz on)	0x00FF	○

Function code	Name	Detailed instruction of parameters	Default value	Modify
		BIT15: reserved		
P07.08	Frequency coefficient	0.01–10.00 Displayed frequency=running frequency × P07.08	1.00	○
P07.09	Rotation speed coefficient	0.1–999.9% Mechanical rotation speed =120 × displayed running frequency × P07.09/motor pole pairs	100.0%	○
P07.10	Linear speed coefficient	0.1–999.9% Linear speed= Mechanical rotation speed × P07.10	1.0%	○
P07.11	Rectifier bridge module temperature	-20.0–120.0°C		●
P07.12	Inverter module temperature	-20.0–120.0°C		●
P07.13	Software version	1.00–655.35		●
P07.14	Local accumulative running time	0–65535h		●
P07.15	High bit of power consumption	Display the power used by the VFD. The power consumption of the VFD =P07.15×1000+P07.16		●
P07.16	Low bit of power consumption	Setting range of P07.15: 0–65535kWh (×1000) Setting range of P07.16: 0.0–999.9kWh		●
P07.17	Reserved	Reserved		●
P07.18	The rated power of the VFD	0.4–3000.0kW		●
P07.19	The rated voltage of the VFD	50–1200V		●
P07.20	The rated current of the VFD	0.1–6000.0A		●
P07.21	Factory bar code 1	0x0000–0xFFFF		●

Function code	Name	Detailed instruction of parameters	Default value	Modify
P07.22	Factory bar code 2	0x0000-0xFFFF		●
P07.23	Factory bar code 3	0x0000-0xFFFF		●
P07.24	Factory bar code 4	0x0000-0xFFFF		●
P07.25	Factory bar code 5	0x0000-0xFFFF		●
P07.26	Factory bar code 6	0x0000-0xFFFF		●
P07.27	Current fault type	0: No fault 1: Inverter unit U phase protection(OUt1) 2: Inverter unit V phase protection(OUt2) 3: Inverter unit W phase protection(OUt3) 4: ACC overcurrent (OC1) 5: DEC overcurrent (OC2) 6: Constant-speed overcurrent (OC3) 7: ACC overvoltage (OV1) 8: DEC overvoltage (OV2) 9: Constant-speed overvoltage (OV3) 10: Bus undervoltage (UV) 11: Motor overload (OL1) 12: The VFD overload (OL2)		●
P07.28	Previous fault type	13: Input side phase loss (SPI) 14: Output side phase loss (SPO) 15: Overheat of the rectifier module (OH1) 16: Overheat fault of the inverter module (OH2) 17: External fault (EF) 18: 485 communication fault (CE) 19: Current detection fault (ItE) 20: Motor antotune fault (tE) 21: EEPROM operation fault (EEP) 22: PID response offline fault (PIDE) 23: Braking unit fault (bCE) 24: Running time arrival (END)		●
P07.29	Previous 2 fault type	25: Electrical overload (OL3) 26: Panel communication fault (PCE)		●

Function code	Name	Detailed instruction of parameters	Default value	Modify
P07.30	Previous 3 fault type	27: Parameter uploading fault (UPE) 28: Parameter downloading fault (DNE)		●
P07.31	Previous 4 fault type	29: PROFIBUS communication fault (E-DP) 30: Ethernet communication fault (E-NET)		●
P07.32	Previous 5 fault type	31: CANopen communication fault (E-CAN) 32: Grounding short circuit fault 1 (ETH1) 33: Grounding short circuit fault 2 (ETH2) 34: Speed deviation fault (dEu) 35: Maladjustment (STo) 36: Undervoltage fault (LL)		●
P07.33	Running frequency at current fault		0.00Hz	●
P07.34	Ramp reference frequency at current fault		0.00Hz	●
P07.35	Output voltage at current fault		0V	●
P07.36	Output current at current fault		0.0A	●
P07.37	Bus voltage at current fault		0.0V	●
P07.38	The Max. temperature at current fault		0.0°C	●
P07.39	Input terminals state at current fault		0	●
P07.40	Output terminals state at current fault		0	●
P07.41	Running frequency at last fault		0.00Hz	●
P07.42	Ramp reference		0.00Hz	●

Function code	Name	Detailed instruction of parameters	Default value	Modify
	frequency at last fault			
P07.43	Output voltage at last fault		0V	●
P07.44	The output current at last fault		0.0A	●
P07.45	Bus voltage at last fault		0.0V	●
P07.46	The Max. temperature at last fault		0.0°C	●
P07.47	Input terminals state at last fault		0	●
P07.48	Output terminals state at last fault		0	●
P07.49	Runnig frequency at last but one fault		0.00Hz	●
P07.50	Output voltage at last but one faults		0.00Hz	●
P07.51	Output current at last but one faults		0V	●
P07.52	Output current at last but one fault		0.0A	●
P07.53	Bus voltage at last but one fault		0.0V	●
P07.54	The Max. temperature at last but one		0.0°C	●

Function code	Name	Detailed instruction of parameters	Default value	Modify
	fault			
P07.55	Input terminals state at last but one fault		0	●
P07.56	Output terminals state at last but one fault		0	●
P08 Group Enhanced function				
P08.00	ACC time 2	See P00.11 and P00.12 for detailed definition. Goodrive300 series define four groups of ACC/DEC time which can be selected by P5 group. The first group of ACC/DEC time is the factory default one. Setting range: 0.0–3600.0s	Depend on model	○
P08.01	DEC time 2		Depend on model	○
P08.02	ACC time 3		Depend on model	○
P08.03	DEC time 3		Depend on model	○
P08.04	ACC time 4		Depend on model	○
P08.05	DEC time 4		Depend on model	○
P08.06	Jogging frequency	This parameter is used to define the reference frequency during jogging. Setting range: 0.00 Hz–P00.03 (Max. frequency)	5.00Hz	○
P08.07	Jogging ACC time	The jogging ACC time means the time needed if the VFD runs from 0Hz to the Max. Frequency.	Depend on model	○
P08.08	Jogging DEC time	The jogging DEC time means the time needed if the VFD goes from the Max. frequency (P00.03) to 0Hz. Setting range: 0.0–3600.0s	Depend on model	○
P08.09	Jump	When the set frequency is in the range of jumping	0.00Hz	○

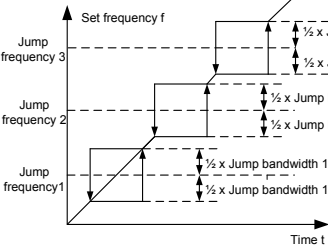
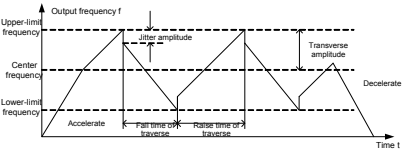
Function code	Name	Detailed instruction of parameters	Default value	Modify
	frequency 1	frequency, the VFD will run at the edge of the jumping frequency. The VFD can avoid the mechanical resonance point by setting the jumping frequency. The VFD can set three jumping frequency. But this function will be invalid if all jumping points are 0. 		
P08.10	Jump frequency bandwidth 1		0.00Hz	<input type="radio"/>
P08.11	Jump frequency 2		0.00Hz	<input type="radio"/>
P08.12	Jump frequency bandwidth 2		0.00Hz	<input type="radio"/>
P08.13	Jump frequency 3		0.00Hz	<input type="radio"/>
P08.14	Jumping frequency range 3		Setting range: 0.00Hz–P00.03 (Max. output frequency)	0.00Hz
P08.15	Traverse range	This function applies to the industries where traverse and convolution function are required such as textile and chemical fiber. The traverse function means that the output frequency of the VFD is fluctuated with the set frequency as its center. The route of the running frequency is illustrated as below, of which the traverse is set by P08.15 and when P08.15 is set as 0, the traverse is 0 with no function.	0.0%	<input type="radio"/>
P08.16	Sudden jumping frequency range		0.0%	<input type="radio"/>
P08.17	Traverse boost time		5.0s	<input type="radio"/>
P08.18	Traverse declining time	 <p>Traverse range: The traverse running is limited by upper and low frequency. The traverse range corresponds to the center frequency: $\text{traverse range AW} = \text{center frequency} \times \text{traverse range P08.15}$. Sudden jumping frequency = $\text{traverse range AW} \times \text{sudden jumping frequency range P08.16}$. When run at the traverse frequency, the value</p>	5.0s	<input type="radio"/>

Function code	Name	Detailed instruction of parameters	Default value	Modify
		<p>corresponds to the sudden jumping frequency.</p> <p>The raising time of the traverse frequency: The time from the lowest point to the highest one.</p> <p>The declining time of the traverse frequency: The time from the highest point to the lowest one.</p> <p>Setting range of P08.15: 0.0–100.0% (corresponding to the set frequency)</p> <p>Setting range of P08.16: 0.0–50.0% (corresponding to the traverse range)</p> <p>Setting range of P08.17: 0.1–3600.0s</p> <p>Setting range of P08.18: 0.1–3600.0s</p>		
P08.19	Set length	<p>The function codes of setting length, actual length and unit pulse are mainly used to control the fixed length.</p> <p>The length is counted by the pulse signal of HDI terminals input and the HDI terminals are needed to set as the length counting input.</p> <p>Actual length = the length counting input pulse / unit pulse</p>	0m	<input type="radio"/>
P08.20	Actual length		0m	<input checked="" type="radio"/>
P08.21	Pulse per rotation		1	<input type="radio"/>
P08.22	Alxe perimeter		10.00 cm	<input type="radio"/>
P08.23	Length ratio		1.000	<input type="radio"/>
P08.24	Length correcting coefficient	<p>When the actual length P08.20 exceeds the set length P08.19, the multi-function digital output terminals will output ON.</p> <p>Setting range of P08.19: 0–65535m</p> <p>Setting range of P08.20: 0–65535m</p> <p>Setting range of P08.21: 1–10000</p> <p>Setting range of P08.22: 0.01–100.00cm</p> <p>Setting range of P08.23: 0.001–10.000</p> <p>Setting range of P08.24: 0.001–1.000</p>	1.000	<input type="radio"/>
P08.25	Set count value	The counter works based on the input pulse signals of the HDI terminals.	0	<input type="radio"/>
P08.26	Specified count value	<p>When the count value reaches the specified number, the multi-function output terminal sends the signal of "The specified count value is reached" and the counter continues to count; when the count value reaches the set number, the multi-function output terminal sends the signal of "The set count value is reached", and the counter will be reset to zero and recount when the next</p>	0	<input type="radio"/>

Function code	Name	Detailed instruction of parameters	Default value	Modify
		<p>pulse occurs.</p> <p>The value of P08.26 cannot be greater than that of P08.25.</p> <p>The function is illustrated as below:</p> <p>Setting range of P08.25: P08.26–65535 Setting range of P08.26: 0–P08.25</p>		
P08.27	Set running time	<p>Pre-set running time of the VFD. When the accumulative running time achieves the set time, the multi-function digital output terminals will output the signal of "running time arrival".</p> <p>Setting range: 0–65535m</p>	0m	<input type="radio"/>
P08.28	Automatic fault reset times	<p>Automatic fault reset times: set the automatic fault reset times. If the reset time exceeds this set value, the VFD will stop to wait maintenance.</p>	0	<input type="radio"/>
P08.29	Interval time of automatic fault reset	<p>Interval time of automatic fault reset: the interval between the time when the fault occurs and the time when the reset action occurs.</p> <p>Setting range of P08.28: 0–10 Setting range of P08.29: 0.1–3600.0s</p>	1.0s	<input type="radio"/>
P08.30	Frequency decreasing ratio of the dropping control	<p>The output frequency of the VFD changes as the load. And it is mainly used to balance the power when several VFDs drive one load.</p> <p>Setting range: 0.00–50.00Hz</p>	0.00Hz	<input type="radio"/>
P08.31	Motor shifting	<p>Goodrive300 supports the shift between two motors. This function is used to select the shifting channel.</p> <p>LED ones: shifting channel</p> <p>0: terminal shifting; digital terminal is 35</p> <p>1: Modbus communication shifting</p> <p>2: PROFIBUS/CANopen communication shifting</p> <p>3: Ethernet communication shifting</p> <p>4: Reserved</p> <p>LED tens: shifting enabling in operation</p>	0	<input checked="" type="radio"/>

Function code	Name	Detailed instruction of parameters	Default value	Modify
		0: Disabled 1: Enabled 0x00—0x14		
P08.32	FDT1 electrical level detection value	When the output frequency exceeds the corresponding frequency of FDT electrical level, the multi-function digital output terminals will output the signal of "frequency level detect FDT" until the output frequency decreases to a value lower than (FDT electrical level—FDT retention detection value) the corresponding frequency, the signal is invalid. Below is the wave form diagram:	50.00 Hz	<input type="radio"/>
P08.33	FDT1 retention detection value		5.0%	<input type="radio"/>
P08.34	FDT2 electrical level detection value		50.00 Hz	<input type="radio"/>
P08.35	FDT2 retention detection value	Setting range of P08.32: 0.00Hz—P00.03 (Max. frequency) Setting range of P08.33: 0.0—100.0% (FDT1 electrical level) Setting range of P08.34: 0.00Hz—P00.03 (Max. frequency) Setting range of P08.35: 0.0—100.0% (FDT2 electrical level)	5.0%	<input type="radio"/>
P08.36	Frequency arrival detection range	When the output frequency is among the positive or negative detection range of the set frequency, the multi-function digital output terminal will output the signal of "frequency arrival", see the diagram below for detailed information:	0.00Hz	<input type="radio"/>

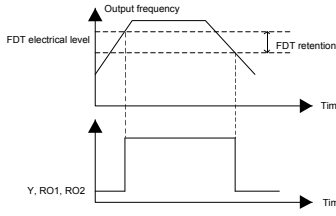

Function code	Name	Detailed instruction of parameters	Default value	Modify								
		<p>Setting range: 0.00Hz–P00.03 (Max. frequency)</p>										
P08.37	Enable dynamic braking	<p>This parameter is used to control the enabling of the internal braking pipe inside the VFD.</p> <p>0: Disable 1: Enable</p> <p>Note: This function is only applicable to the internal braking pipe.</p>	0	<input type="radio"/>								
P08.38	Dynamic braking threshold voltage	<p>Set the initial bus voltage for dynamic braking. This value can be adjusted to perform valid braking on a load. The factory setting changes with the voltage class.</p> <p>Setting range: 200.0–2000.0V</p> <p>To prevent customers from setting a value that is too large, the following setting ranges are recommended:</p> <table border="1"> <tr> <td>Voltage</td> <td>380V</td> <td>500V</td> <td>660</td> </tr> <tr> <td>Range</td> <td>685–750V</td> <td>860–950V</td> <td>1080–1180V</td> </tr> </table>	Voltage	380V	500V	660	Range	685–750V	860–950V	1080–1180V	380V voltage: 700.0V	<input type="radio"/>
		Voltage	380V	500V	660							
Range	685–750V	860–950V	1080–1180V									
<p>660V voltage: 1120.0V</p>	500V voltage: 900.0V											
P08.39	Cooling fan running mode	<p>0: Normal mode 1: The fan keeps running after being powered on.</p>	0	<input type="radio"/>								
P08.40	PWM selection	<p>0x00–0x21</p> <p>LED ones: PWM mode selection</p> <p>0: PWM mode 1, three-phase modulation and two-modulation 1: PWM mode 2, three-phase modulation</p> <p>LED tens: low-speed carrier frequency limit mode</p> <p>0: Low-speed carrier frequency limit mode 1, the carrier frequency will limit to 2k if it exceeds 2k at low speed 1: Low-speed carrier frequency limit mode 2, the</p>	01	<input checked="" type="radio"/>								

Function code	Name	Detailed instruction of parameters	Default value	Modify
		carrier frequency will limit to 4k if it exceeds 4k at low speed 2: No limit		
P08.41	Overmodulation	LED ones 0: Invalid 1: Valid LED tens (for factory commissioning) 0: Light overcommission; in zone 1 1: Heavy overcommission; in zone 2	01	⊙
P08.42	Keypad data control	0x000–0x1223 LED ones: frequency enable selection 0: Both \wedge / \vee keys and digital potentiometer adjustments are valid 1: Only \wedge / \vee keys adjustment is valid 2: Only digital potentiometer adjustments is valid 3: Neither \wedge / \vee keys nor digital potentiometer adjustments are valid LED tens: frequency control selection 0: Only valid when P00.06=0 or P00.07=0 1: Valid for all frequency setting manner 2: Invalid for multi-step speed when multi-step speed has the priority LED hundreds: action selection during stopping 0: Setting is valid 1: Valid during running, cleared after stopping 2: Valid during running, cleared after receiving the stop command LED thousands: \wedge / \vee keys and digital potentiometer integral function 0: The integral function is valid 1: The integral function is invalid	0x0000	○
P08.43	Integral ratio of the keypad potentiometer	0.01–10.00s	0.10s	○
P08.44	UP/DOWN terminals control	0x000–0x221 LED ones: frequency control selection 0: UP/DOWN terminals setting valid 1: UP/DOWN terminals setting valid	0x000	○

Function code	Name	Detailed instruction of parameters	Default value	Modify
		LED tens: frequency control selection 0: Only valid when P00.06=0 or P00.07=0 1: All frequency means are valid 2: When the multi-step are priority, it is invalid to the multi-step LED hundreds: action selection when stop 0: Setting valid 1: Valid in the running, clear after stop 2: Valid in the running, clear after receiving the stop commands		
P08.45	UP terminals frequency changing ratio	0.01–50.00Hz/s	0.50 Hz/s	<input type="radio"/>
P08.46	DOWN terminals frequency changing ratio	0.01–50.00 Hz/s	0.50 Hz/s	<input type="radio"/>
P08.47	Frequency setting at power loss	0x000–0x111 LED ones: Action selection when power off. 0: Save when power off 1: Clear when power off LED tens: Action selection when Modbus set frequency off 0: Save when power off 1: Clear when power off LED hundreds: The action selection when other frequency set frequency off 0: Save when power off 1: Clear when power off	0x000	<input type="radio"/>
P08.48	High bit of initial power consumption	This parameter is used to set the original value of the power consumption. The original value of the power consumption	0 kWh	<input type="radio"/>
P08.49	Low bit of initial power consumption	=P08.48×1000+P08.49 (kWh) Setting range of P08.48: 0–59999 kWh (k) Setting range of P08.49: 0.0–999.9 kWh	0.0 kWh	<input type="radio"/>
P08.50	Magnetic flux braking	This function code is used to enable magnetic flux.	0	<input checked="" type="radio"/>

Function code	Name	Detailed instruction of parameters	Default value	Modify
		<p>0: Invalid.</p> <p>100–150: The bigger the coefficient, the stronger the braking is.</p> <p>This VFD is used to increase the magnetic flux to decelerate the motor. The energy generated by the motor during braking can be converted into heat energy by increasing the magnetic flux.</p> <p>The VFD monitors the state of the motor continuously even during the magnetic flux period. So the magnetic flux can be used in the motor stop, as well as to change the rotation speed of the motor. Its other advantages are:</p> <p>Brake immediately after the stop command. It does not need to wait the magnetic flux to weaken.</p> <p>Better cooling for motors. The current of the stator other than the rotor increases during magnetic flux braking, while the cooling of the stator is more effective than the rotor.</p>		
P08.51	Current adjustment coefficient on the input side	<p>This function code is used to adjust the displayed current of the AC input side.</p> <p>Setting range: 0.00–1.00</p>	0.56	<input type="radio"/>
P09 Group PID control				
P09.00	PID reference source	<p>When the frequency command selection (P00.06, P00.07) is 7 or the voltage setting channel selection (P04.27) is 6, the running mode of the VFD is procedure PID controlled.</p> <p>The parameter determines the target given channel during the PID procedure.</p> <p>0: Keypad (P09.01)</p> <p>1: AI1</p> <p>2: AI2</p> <p>3: AI3</p> <p>4: HDI</p> <p>5: Multi-step speed set</p> <p>6: Modbus communication set</p> <p>7: PROFIBUS/CANopen communication set</p>	0	<input type="radio"/>

Function code	Name	Detailed instruction of parameters	Default value	Modify
		8: Ethernet communication set 9: Reserved The setting target of procedure PID is a relative one, 100% of the setting equals to 100% of the response of the controlled system. The system is calculated according to the relative value (0–100.0%). Note: Set multi-step speed, which can be completed by setting P10 group parameters. For PROFIBUS, Ethernet, and CANopen communication setting, corresponding extension cards are needed.		
P09.01	Keypad PID preset	When P09.00=0, set the parameter whose basic value is the response value of the system. Setting range: -100.0%–100.0%	0.0%	○
P09.02	PID feedback source	Select the PID channel by the parameter. 0: AI1 1: AI2 2: AI3 3: HDI 4: Modbus communication feedback 5: PROFIBUS/CANopen communication feedback 6: Ethernet communication feedback 7: Reserved Note: The reference and feedback channel cannot coincide, otherwise, PID cannot control effectively.	0	○
P09.03	PID output feature	0: PID output is positive: when the feedback signal exceeds the PID given value, the output frequency of the VFD will decrease to balance the PID. For example, the strain PID control during wrapup 1: PID output is negative: When the feedback signal is stronger than the PID given value, the output frequency of the VFD will increase to balance the PID. For example, the strain PID	0	○

Function code	Name	Detailed instruction of parameters	Default value	Modify
		control during wrapdown.		
P09.04	Proportional gain (Kp)	<p>The function is applied to the proportional gain P of PID input.</p> <p>P determines the strength of the whole PID adjuster. The parameter of 100 means that when the offset of PID feedback and given value is 100%, the adjusting range of PID adjuster is the Max. frequency (ignoring integral and differential function).</p> <p>Setting range: 0.00–100.00</p>	1.00	<input type="radio"/>
P09.05	Intergal time (Ti)	<p>This parameter determines the speed of PID adjuster to carry out integral adjustment on the deviation of PID feedback and reference.</p> <p>When the deviation of PID feedback and reference is 100%, the integral adjuster works continuously after the time (ignoring the proportional effect and differential effect) to achieve the Max. Frequency (P00.03) or the Max. Voltage (P04.31). Shorter the integral time, stronger is the adjustment.</p> <p>Setting range: 0.00–10.00s</p>	0.10s	<input type="radio"/>
P09.06	Differential time (Td)	<p>This parameter determines the strength of the change ratio when PID adjuster carries out integral adjustment on the deviation of PID feedback and reference.</p> <p>If the PID feedback changes 100% during the time, the adjustment of integral adjuster (ignoring the proportional effect and differential effect) is the Max. Frequency (P00.03) or the Max. Voltage (P04.31). Longer the integral time, stronger is the adjusting.</p> <p>Setting range: 0.00–10.00s</p>	0.00s	<input type="radio"/>
P09.07	Sampling cycle (T)	<p>This parameter means the sampling cycle of the feedback. The adjuster operates each sampling cycle. The longer the sampling cycle is, the slower the response is.</p>	0.100s	<input type="radio"/>

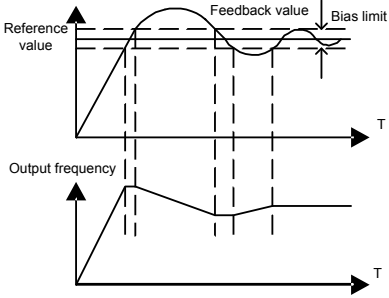
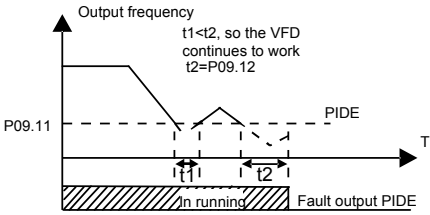
Function code	Name	Detailed instruction of parameters	Default value	Modify
		Setting range: 0.000–10.000s		
P09.08	PID control deviation limit	<p>The output of PID system is the maximum deviation corresponding to close loop reference. As shown in the diagram below, PID adjustor stops to work during the deviation limit. Set the function properly to adjust the accuracy and stability of the system.</p>  <p>Setting range: 0.0–100.0%</p>	0.0%	○
P09.09	Output upper limit of PID	This parameter is used to set the upper and lower limit of the PID adjustor output.	100.0%	○
P09.10	Output lower limit of PID	100.0 % corresponds to max. frequency or the max. voltage of (P04.31) Setting range of P09.09: P09.10–100.0% Setting range of P09.10: -100.0%–P09.09	0.0%	○
P09.11	Detection value of feedback offline	Set the detection value of feedback offline, when the feedback detection value is smaller than or equals to the detected value, and the lasting time exceeds the set value in P09.12, the VFD will report "PID feedback offline fault" and the keypad will display PIDE.	0.0%	○
P09.12	Detection time of feedback offline	 <p>Setting range: 0.0–100.0%</p>	1.0s	○

Function code	Name	Detailed instruction of parameters	Default value	Modify
		Setting range of P09.11: 0.0–100.0% Setting range of P09.12: 0.0–3600.0s		
P09.13	PID adjustment	<p>0x0000–0x1111</p> <p>LED ones:</p> <p>0: Keep on integral adjustment when the frequency achieves the upper and low limit; the integration shows the change between the reference and the feedback unless it reaches the internal integral limit. When the trend between the reference and the feedback changes, it needs more time to offset the impact of continuous working and the integration will change with the trend.</p> <p>1: Stop integral adjustment when the frequency achieves the upper and low limit. If the integration keeps stable, and the trend between the reference and the feedback changes, the integration will change with the trend quickly.</p> <p>LED tens: P00.08 is 0</p> <p>0: The same with the setting direction; if the output of PID adjustment is different from the current running direction, the internal will output 0 forcedly.</p> <p>1: Opposite to the setting direction</p> <p>LED hundreds: P00.08 is 0</p> <p>0: Limit to the maximum frequency</p> <p>1: Limit to frequency A</p> <p>LED thousands:</p> <p>0: A+B frequency, the buffer of A frequency is invalid</p> <p>1: A+B frequency, the buffer of A frequency is valid</p> <p>ACC/DEC is determined by ACC time 4 of P08.04</p>	0x0001	○
P09.14	Proportional gain at low frequency (Kp)	0.00–100.00	1.00	○
P09.15	PID command	0.0–1000.0s	0.0s	○

Function code	Name	Detailed instruction of parameters	Default value	Modify
	of ACC/DEC time			
P09.16	PID output filter time	0.000–10.000s	0.000s	○
P10 Group Simple PLC and multi-step speed control				
P10.00	Simple PLC	0: Stop after running once. The VFD has to be commanded again after finishing a cycle. 1: Run at the final value after running once. After finish a signal, the VFD will keep the running frequency and direction of the last run. 2: Cycle running. The VFD will keep on running until receiving a stop command d. And then, the system will stop.	0	○
P10.01	Simple PLC memory	0: Power loss without memory 1: Power loss with memory; PLC record the running stage and frequency when power loss.	0	○
P10.02	Multi-step speed 0	The frequency setting range of stage 0–15: -100.0–100.0%, 100.0% of the frequency setting corresponds to the Max. Frequency P00.03.	0.0%	○
P10.03	Running time of step 0	The operation time setting of stage 0–15: the time unit is determined by P10.37. When selecting simple PLC running, set P10.02–P10.33 to define the running frequency and time of all stages.	0.0s	○
P10.04	Multi-step speed 1		0.0%	○
P10.05	Running time of step 1	Note: The symbol of multi-step determines the running direction of simple PLC. The negative value means reverse rotation.	0.0s	○
P10.06	Multi-step speed 2		0.0%	○
P10.07	Running time of step 2		0.0s	○
P10.08	Multi-step speed 3		0.0%	○
P10.09	Running time of step 3		0.0s	○
P10.10	Multi-step speed 4		0.0%	○
P10.11	Running time of step 4		0.0s	○
P10.12	Multi-step		0.0%	○

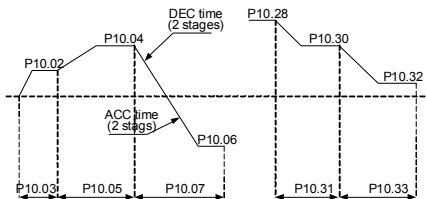

Function code	Name	Detailed instruction of parameters	Default value	Modify																																														
	speed 5	<p>terminals 1–4 (select the setting by S terminals, the corresponding function codes are P05.01–P05.09), corresponding to the speed 1 to speed 15.</p>																																																
P10.13	Running time of step 5		0.0s	<input type="radio"/>																																														
P10.14	Multi-step speed 6		0.0%	<input type="radio"/>																																														
P10.15	Running time of step 6		0.0s	<input type="radio"/>																																														
P10.16	Multi-step speed 7		0.0%	<input type="radio"/>																																														
P10.17	Running time of step 7		0.0s	<input type="radio"/>																																														
P10.18	Multi-step speed 8		0.0%	<input type="radio"/>																																														
P10.19	Running time of step 8		0.0s	<input type="radio"/>																																														
P10.20	Multi-step speed 9		0.0%	<input type="radio"/>																																														
P10.21	Running time of step 9		0.0s	<input type="radio"/>																																														
P10.22	Multi-step speed 10		0.0%	<input type="radio"/>																																														
P10.23	Running time of step 10		The relationship between terminal 1, terminal 2, terminal 3, terminal 4 and multi-step speed is as following:	0.0s	<input type="radio"/>																																													
P10.24	Multi-step speed 11		<table border="1"> <tr> <td>Terminal 1</td> <td>OFF</td> <td>ON</td> <td>OFF</td> <td>ON</td> <td>OFF</td> <td>ON</td> <td>OFF</td> <td>ON</td> </tr> <tr> <td>Terminal 2</td> <td>OFF</td> <td>OFF</td> <td>ON</td> <td>ON</td> <td>OFF</td> <td>OFF</td> <td>ON</td> <td>ON</td> </tr> <tr> <td>Terminal 3</td> <td>OFF</td> <td>OFF</td> <td>OFF</td> <td>OFF</td> <td>ON</td> <td>ON</td> <td>ON</td> <td>ON</td> </tr> <tr> <td>Terminal 4</td> <td>OFF</td> <td>OFF</td> <td>OFF</td> <td>OFF</td> <td>OFF</td> <td>OFF</td> <td>OFF</td> <td>OFF</td> </tr> <tr> <td>Step</td> <td>0</td> <td>1</td> <td>2</td> <td>3</td> <td>4</td> <td>5</td> <td>6</td> <td>7</td> </tr> </table>	Terminal 1	OFF	ON	OFF	ON	OFF	ON	OFF	ON	Terminal 2	OFF	OFF	ON	ON	OFF	OFF	ON	ON	Terminal 3	OFF	OFF	OFF	OFF	ON	ON	ON	ON	Terminal 4	OFF	OFF	OFF	OFF	OFF	OFF	OFF	OFF	Step	0	1	2	3	4	5	6	7	0.0%	<input type="radio"/>
Terminal 1	OFF		ON	OFF	ON	OFF	ON	OFF	ON																																									
Terminal 2	OFF		OFF	ON	ON	OFF	OFF	ON	ON																																									
Terminal 3	OFF	OFF	OFF	OFF	ON	ON	ON	ON																																										
Terminal 4	OFF	OFF	OFF	OFF	OFF	OFF	OFF	OFF																																										
Step	0	1	2	3	4	5	6	7																																										
P10.25	Running time of step 11	<table border="1"> <tr> <td>Terminal 1</td> <td>OFF</td> <td>ON</td> <td>OFF</td> <td>ON</td> <td>OFF</td> <td>ON</td> <td>OFF</td> <td>ON</td> </tr> <tr> <td>Terminal 2</td> <td>OFF</td> <td>OFF</td> <td>ON</td> <td>ON</td> <td>OFF</td> <td>OFF</td> <td>ON</td> <td>ON</td> </tr> <tr> <td>Terminal 3</td> <td>OFF</td> <td>OFF</td> <td>OFF</td> <td>OFF</td> <td>ON</td> <td>ON</td> <td>ON</td> <td>ON</td> </tr> <tr> <td>Terminal 4</td> <td>ON</td> <td>ON</td> <td>ON</td> <td>ON</td> <td>ON</td> <td>ON</td> <td>ON</td> <td>ON</td> </tr> <tr> <td>Step</td> <td>8</td> <td>9</td> <td>10</td> <td>11</td> <td>12</td> <td>13</td> <td>14</td> <td>15</td> </tr> </table>	Terminal 1	OFF	ON	OFF	ON	OFF	ON	OFF	ON	Terminal 2	OFF	OFF	ON	ON	OFF	OFF	ON	ON	Terminal 3	OFF	OFF	OFF	OFF	ON	ON	ON	ON	Terminal 4	ON	ON	ON	ON	ON	ON	ON	ON	Step	8	9	10	11	12	13	14	15	0.0s	<input type="radio"/>	
Terminal 1	OFF	ON	OFF	ON	OFF	ON	OFF	ON																																										
Terminal 2	OFF	OFF	ON	ON	OFF	OFF	ON	ON																																										
Terminal 3	OFF	OFF	OFF	OFF	ON	ON	ON	ON																																										
Terminal 4	ON	ON	ON	ON	ON	ON	ON	ON																																										
Step	8	9	10	11	12	13	14	15																																										
P10.26	Multi-step speed 12	<table border="1"> <tr> <td>Terminal 1</td> <td>OFF</td> <td>ON</td> <td>OFF</td> <td>ON</td> <td>OFF</td> <td>ON</td> <td>OFF</td> <td>ON</td> </tr> <tr> <td>Terminal 2</td> <td>OFF</td> <td>OFF</td> <td>ON</td> <td>ON</td> <td>OFF</td> <td>OFF</td> <td>ON</td> <td>ON</td> </tr> <tr> <td>Terminal 3</td> <td>OFF</td> <td>OFF</td> <td>OFF</td> <td>OFF</td> <td>ON</td> <td>ON</td> <td>ON</td> <td>ON</td> </tr> <tr> <td>Terminal 4</td> <td>ON</td> <td>ON</td> <td>ON</td> <td>ON</td> <td>ON</td> <td>ON</td> <td>ON</td> <td>ON</td> </tr> <tr> <td>Step</td> <td>8</td> <td>9</td> <td>10</td> <td>11</td> <td>12</td> <td>13</td> <td>14</td> <td>15</td> </tr> </table>	Terminal 1	OFF	ON	OFF	ON	OFF	ON	OFF	ON	Terminal 2	OFF	OFF	ON	ON	OFF	OFF	ON	ON	Terminal 3	OFF	OFF	OFF	OFF	ON	ON	ON	ON	Terminal 4	ON	ON	ON	ON	ON	ON	ON	ON	Step	8	9	10	11	12	13	14	15	0.0%	<input type="radio"/>	
Terminal 1	OFF	ON	OFF	ON	OFF	ON	OFF	ON																																										
Terminal 2	OFF	OFF	ON	ON	OFF	OFF	ON	ON																																										
Terminal 3	OFF	OFF	OFF	OFF	ON	ON	ON	ON																																										
Terminal 4	ON	ON	ON	ON	ON	ON	ON	ON																																										
Step	8	9	10	11	12	13	14	15																																										
P10.27	Running time of step 12	<table border="1"> <tr> <td>Terminal 1</td> <td>OFF</td> <td>ON</td> <td>OFF</td> <td>ON</td> <td>OFF</td> <td>ON</td> <td>OFF</td> <td>ON</td> </tr> <tr> <td>Terminal 2</td> <td>OFF</td> <td>OFF</td> <td>ON</td> <td>ON</td> <td>OFF</td> <td>OFF</td> <td>ON</td> <td>ON</td> </tr> <tr> <td>Terminal 3</td> <td>OFF</td> <td>OFF</td> <td>OFF</td> <td>OFF</td> <td>ON</td> <td>ON</td> <td>ON</td> <td>ON</td> </tr> <tr> <td>Terminal 4</td> <td>ON</td> <td>ON</td> <td>ON</td> <td>ON</td> <td>ON</td> <td>ON</td> <td>ON</td> <td>ON</td> </tr> <tr> <td>Step</td> <td>8</td> <td>9</td> <td>10</td> <td>11</td> <td>12</td> <td>13</td> <td>14</td> <td>15</td> </tr> </table>	Terminal 1	OFF	ON	OFF	ON	OFF	ON	OFF	ON	Terminal 2	OFF	OFF	ON	ON	OFF	OFF	ON	ON	Terminal 3	OFF	OFF	OFF	OFF	ON	ON	ON	ON	Terminal 4	ON	ON	ON	ON	ON	ON	ON	ON	Step	8	9	10	11	12	13	14	15	0.0s	<input type="radio"/>	
Terminal 1	OFF	ON	OFF	ON	OFF	ON	OFF	ON																																										
Terminal 2	OFF	OFF	ON	ON	OFF	OFF	ON	ON																																										
Terminal 3	OFF	OFF	OFF	OFF	ON	ON	ON	ON																																										
Terminal 4	ON	ON	ON	ON	ON	ON	ON	ON																																										
Step	8	9	10	11	12	13	14	15																																										
P10.28	Multi-step speed 13	<table border="1"> <tr> <td>Terminal 1</td> <td>OFF</td> <td>ON</td> <td>OFF</td> <td>ON</td> <td>OFF</td> <td>ON</td> <td>OFF</td> <td>ON</td> </tr> <tr> <td>Terminal 2</td> <td>OFF</td> <td>OFF</td> <td>ON</td> <td>ON</td> <td>OFF</td> <td>OFF</td> <td>ON</td> <td>ON</td> </tr> <tr> <td>Terminal 3</td> <td>OFF</td> <td>OFF</td> <td>OFF</td> <td>OFF</td> <td>ON</td> <td>ON</td> <td>ON</td> <td>ON</td> </tr> <tr> <td>Terminal 4</td> <td>ON</td> <td>ON</td> <td>ON</td> <td>ON</td> <td>ON</td> <td>ON</td> <td>ON</td> <td>ON</td> </tr> <tr> <td>Step</td> <td>8</td> <td>9</td> <td>10</td> <td>11</td> <td>12</td> <td>13</td> <td>14</td> <td>15</td> </tr> </table>	Terminal 1	OFF	ON	OFF	ON	OFF	ON	OFF	ON	Terminal 2	OFF	OFF	ON	ON	OFF	OFF	ON	ON	Terminal 3	OFF	OFF	OFF	OFF	ON	ON	ON	ON	Terminal 4	ON	ON	ON	ON	ON	ON	ON	ON	Step	8	9	10	11	12	13	14	15	0.0%	<input type="radio"/>	
Terminal 1	OFF	ON	OFF	ON	OFF	ON	OFF	ON																																										
Terminal 2	OFF	OFF	ON	ON	OFF	OFF	ON	ON																																										
Terminal 3	OFF	OFF	OFF	OFF	ON	ON	ON	ON																																										
Terminal 4	ON	ON	ON	ON	ON	ON	ON	ON																																										
Step	8	9	10	11	12	13	14	15																																										
P10.29	Running time of step 13		0.0s	<input type="radio"/>																																														
P10.30	Multi-step speed 14		0.0%	<input type="radio"/>																																														

Function code	Name	Detailed instruction of parameters	Default value	Modify																																																																																																									
P10.31	Running time of step 14		0.0s	<input type="radio"/>																																																																																																									
P10.32	Multi-step speed 15		0.0%	<input type="radio"/>																																																																																																									
P10.33	Running time of step 15		0.0s	<input type="radio"/>																																																																																																									
P10.34	Simple PLC 0–7 step ACC/DEC time	<p>Below is the detailed instruction:</p> <table border="1"> <thead> <tr> <th>Function code</th> <th>Binary bit</th> <th>Step</th> <th>ACC/DEC 0</th> <th>ACC/DEC 1</th> <th>ACC/DEC 2</th> <th>ACC/DEC 3</th> </tr> </thead> <tbody> <tr> <td rowspan="8">P10.34</td> <td>BIT1 BIT0</td> <td>0</td> <td>00</td> <td>01</td> <td>10</td> <td>11</td> </tr> <tr> <td>BIT3 BIT2</td> <td>1</td> <td>00</td> <td>01</td> <td>10</td> <td>11</td> </tr> <tr> <td>BIT5 BIT4</td> <td>2</td> <td>00</td> <td>01</td> <td>10</td> <td>11</td> </tr> <tr> <td>BIT7 BIT6</td> <td>3</td> <td>00</td> <td>01</td> <td>10</td> <td>11</td> </tr> <tr> <td>BIT9 BIT8</td> <td>4</td> <td>00</td> <td>01</td> <td>10</td> <td>11</td> </tr> <tr> <td>BIT11 BIT10</td> <td>5</td> <td>00</td> <td>01</td> <td>10</td> <td>11</td> </tr> <tr> <td>BIT13 BIT12</td> <td>6</td> <td>00</td> <td>01</td> <td>10</td> <td>11</td> </tr> <tr> <td>BIT15 BIT14</td> <td>7</td> <td>00</td> <td>01</td> <td>10</td> <td>11</td> </tr> <tr> <td rowspan="8">P10.35</td> <td>BIT1 BIT0</td> <td>8</td> <td>00</td> <td>01</td> <td>10</td> <td>11</td> </tr> <tr> <td>BIT3 BIT2</td> <td>9</td> <td>00</td> <td>01</td> <td>10</td> <td>11</td> </tr> <tr> <td>BIT5 BIT4</td> <td>10</td> <td>00</td> <td>01</td> <td>10</td> <td>11</td> </tr> <tr> <td>BIT7 BIT6</td> <td>11</td> <td>00</td> <td>01</td> <td>10</td> <td>11</td> </tr> <tr> <td>BIT9 BIT8</td> <td>12</td> <td>00</td> <td>01</td> <td>10</td> <td>11</td> </tr> <tr> <td>BIT11 BIT10</td> <td>13</td> <td>00</td> <td>01</td> <td>10</td> <td>11</td> </tr> <tr> <td>BIT13 BIT12</td> <td>14</td> <td>00</td> <td>01</td> <td>10</td> <td>11</td> </tr> <tr> <td>BIT15 BIT14</td> <td>15</td> <td>00</td> <td>01</td> <td>10</td> <td>11</td> </tr> </tbody> </table> <p>After users select the corresponding ACC/DEC time, the combining 16 binary bit can be changed into hexadecimal bit, and then set the corresponding function codes.</p> <p>ACC/DEC time 1 is set by P00.11 and P00.12; ACC/DEC time 2 is set by P08.00 and P08.01; ACC/DEC time 3 is set by P08.02 and P08.03; ACC/DEC time 4 is set by P08.04 and P08.05.</p>	Function code	Binary bit	Step	ACC/DEC 0	ACC/DEC 1	ACC/DEC 2	ACC/DEC 3	P10.34	BIT1 BIT0	0	00	01	10	11	BIT3 BIT2	1	00	01	10	11	BIT5 BIT4	2	00	01	10	11	BIT7 BIT6	3	00	01	10	11	BIT9 BIT8	4	00	01	10	11	BIT11 BIT10	5	00	01	10	11	BIT13 BIT12	6	00	01	10	11	BIT15 BIT14	7	00	01	10	11	P10.35	BIT1 BIT0	8	00	01	10	11	BIT3 BIT2	9	00	01	10	11	BIT5 BIT4	10	00	01	10	11	BIT7 BIT6	11	00	01	10	11	BIT9 BIT8	12	00	01	10	11	BIT11 BIT10	13	00	01	10	11	BIT13 BIT12	14	00	01	10	11	BIT15 BIT14	15	00	01	10	11	0x0000	<input type="radio"/>
Function code	Binary bit	Step	ACC/DEC 0	ACC/DEC 1	ACC/DEC 2	ACC/DEC 3																																																																																																							
P10.34	BIT1 BIT0	0	00	01	10	11																																																																																																							
	BIT3 BIT2	1	00	01	10	11																																																																																																							
	BIT5 BIT4	2	00	01	10	11																																																																																																							
	BIT7 BIT6	3	00	01	10	11																																																																																																							
	BIT9 BIT8	4	00	01	10	11																																																																																																							
	BIT11 BIT10	5	00	01	10	11																																																																																																							
	BIT13 BIT12	6	00	01	10	11																																																																																																							
	BIT15 BIT14	7	00	01	10	11																																																																																																							
P10.35	BIT1 BIT0	8	00	01	10	11																																																																																																							
	BIT3 BIT2	9	00	01	10	11																																																																																																							
	BIT5 BIT4	10	00	01	10	11																																																																																																							
	BIT7 BIT6	11	00	01	10	11																																																																																																							
	BIT9 BIT8	12	00	01	10	11																																																																																																							
	BIT11 BIT10	13	00	01	10	11																																																																																																							
	BIT13 BIT12	14	00	01	10	11																																																																																																							
	BIT15 BIT14	15	00	01	10	11																																																																																																							
P10.35	Simple PLC 8–15 step ACC/DEC time		0x0000	<input type="radio"/>																																																																																																									

Function code	Name	Detailed instruction of parameters	Default value	Modify								
		Setting range: -0x0000–0xFFFF										
P10.36	PLC restart	0: Restart from the first step; stop during running (cause by the stop command, fault or power loss), run from the first stage after restart. 1: Continue to run from the stop frequency; stop during running(cause by stop command and fault), the VFD will record the running time automatically, enter into the stage after restart and keep the remaining running at the setting frequency.	0	⊙								
P10.37	Multi-step time unit	0: Seconds; the running time of all steps is counted by second 1: Minutes; the running time of all steps is counted by minute	0	⊙								
P11 Group Protective parameters												
P11.00	Phase loss protection	0x00–0x11 LED ones: 0: Input phase loss protection disable 1: Input phase loss protection enable LED tens: 0: Output phase loss protection disable 1: Output phase loss protection enable	11	○								
P11.01	Frequency-decreasing at sudden power loss	0: Disable 1: Enable	0	○								
P11.02	Frequency decreasing ratio at sudden power loss	Setting range: 0.00Hz/s–P00.03 (Max. frequency) After the power loss of the grid, the bus voltage drops to the sudden frequency-decreasing point, the VFD begin to decrease the running frequency at P11.02, to make the VFD generate power again. The returning power can maintain the bus voltage to ensure a rated running of the VFD until the recovery of power. <table border="1" style="margin-left: auto; margin-right: auto;"> <tr> <td>Voltage degree</td> <td>380V</td> <td>500V</td> <td>660V</td> </tr> <tr> <td>Frequency-decreasing point at</td> <td>460V</td> <td>580V</td> <td>800V</td> </tr> </table>	Voltage degree	380V	500V	660V	Frequency-decreasing point at	460V	580V	800V	10.00 Hz/s	○
Voltage degree	380V	500V	660V									
Frequency-decreasing point at	460V	580V	800V									

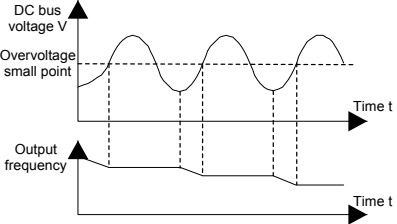
Function code	Name	Detailed instruction of parameters	Default value	Modify
		<p>sudden power loss</p> <p>Note:</p> <ol style="list-style-type: none"> Adjust the parameter properly to avoid the stopping caused by VFD protection during the switching of the grid. Disable input phase loss protection to enable this function. 		
P11.03	Overtoltage stall protection	<p>0:Disable 1: Enable</p> 	1	○
P11.04	Voltage protection of overvoltage stall	<p>120–150%(standard bus voltage)(380V)</p> <p>120–150%(standard bus voltage)(500V)</p> <p>120–150%(standard bus voltage)(660V)</p>	136% 132% 120%	○
P11.05	Current limit action selection	<p>The actual increasing ratio of motor speed is lower than the ratio of output frequency because of the big load during ACC running. It is necessary to take measures to avoid overcurrent fault and the VFD trips.</p> <p>Ones: current limit:</p> <p>0: Invalid 1: Valid</p> <p>Tens: overload alarm of hardware current limit (for factory commissioning)</p> <p>0: Valid 1: Invalid</p>	01	◎

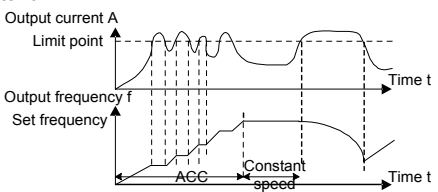
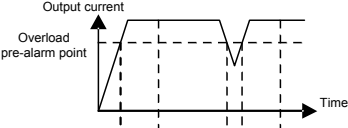
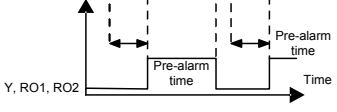
Function code	Name	Detailed instruction of parameters	Default value	Modify
P11.06	Automatic current limit	During the running of the VFD, it will detect the output current and compare it with the limit level defined in P11.06. If it exceeds the level, the VFD will run at stable frequency in ACC running, or the VFD will derate to run during the constant running. If it exceeds the level continuously, the output frequency will keep on decreasing to the lower limit. If the output current is detected to be lower than the limit level, the VFD will accelerate to run.	160.0%	☉
P11.07	Frequency-decreasing ratio during current limit	 <p>Setting range of P11.06: 50.0–200.0% Setting range of P11.07: 0.00–50.00Hz/s</p>	10.00 Hz/s	☉
P11.08	Overload pre-alarm of motor/VFD	The output current of the VFD or the motor is above P11.09 and the lasting time is beyond P11.10, overload pre-alarm will be output.	0x000	○
P11.09	Overload pre-alarm detection		150%	○
P11.10	Overload pre-alarm detection time	 <p>Setting range of P11.08: Enable and define the overload pre-alarm of the VFD or the motor. Setting range: 0x000–0x131 LED ones: 0: Overload pre-alarm of the motor, corresponding to the rated current of the motor 1: Overload pre-alarm of the VFD, corresponding to the rated current of the VFD</p>	1.0s	○

Function code	Name	Detailed instruction of parameters	Default value	Modify
		LED tens: 0: The VFD continues to work after underload pre-alarm 1: The VFD continues to work after underload pre-alarm and the VFD stops to run after overload fault 2: The VFD continues to work after overload pre-alarm and the VFD stops to run after underload fault LED hundreds : 0: Detection all the time 1: Detection in constant running Setting range of P11.09: P11.11–200% Setting range of P11.10: 0.1–3600.0s		
P11.11	Underload pre-alarm detection	If the VFD current or the output current is lower than P11.11, and its lasting time is beyond P11.12, the VFD will output underload pre-alarm.	50%	<input type="radio"/>
P11.12	Underload pre-alarm detection time	Setting range of P11.11: 0–P11.09 Setting range of P11.12: 0.1–3600.0s	1.0s	<input type="radio"/>
P11.13	Output terminal action during fault	Select the action of fault output terminals on undervoltage and fault reset. 0x00–0x11 LED ones: 0: Action under fault undervoltage 1: No action under fault undervoltage LED tens: 0: Action during the automatic reset 1: No action during the automatic reset	0x00	<input type="radio"/>
P11.14	Speed deviation detection	0.0–50.0% Set the speed deviation detection time.	10.0%	<input type="radio"/>
P11.15	Speed deviation detection time	This parameter is used to see the speed deviation detection time.	0.5s	<input type="radio"/>

Function code	Name	Detailed instruction of parameters	Default value	Modify
		<p>Setting range of P11.15: 0.0–10.0s</p>		
P11.16	Automatic frequency-decreasing at voltage drop	0: Invalid 1: Valid; ensure rated output torque when voltage drop	0	<input type="radio"/>
P12 Group Motor 2				
P12.00	Motor type 2	0: Asynchronous motor 1: Synchronous motor Note: Switch the current motor by the switching channel of P08.31.	0	<input checked="" type="radio"/>
P12.01	Rated power of asynchronous motor 2	0.1–3000.0kW	Depend on model	<input checked="" type="radio"/>
P12.02	Rated frequency of asynchronous motor 2	0.01Hz–P00.03 (Max. frequency)	50.00 Hz	<input checked="" type="radio"/>
P12.03	Rated speed of asynchronous motor 2	1–36000rpm	Depend on model	<input checked="" type="radio"/>
P12.04	Rated voltage of asynchronous motor 2	0–1200V	Depend on model	<input checked="" type="radio"/>
P12.05	Rated current of asynchronous	0.8–6000.0A	Depend on model	<input checked="" type="radio"/>

Function code	Name	Detailed instruction of parameters		Default value	Modify
	motor 2		the motor and the standard one is huge, the features of the VFD will decrease. Note: Reset the rated power of the motor (P12.01), initialize the motor parameter of P12.02–P12.05.		
P12.06	Stator resistor of asynchronous motor 2	0.001–65.535Ω	After finish the motor parameter autotuning, the set value of P12.06–P12.10 will renew automatically. These parameters are basic parameters controlled by vectors which directly impact the features. Note: Users cannot modify the parameters freely.	Depend on model	<input type="radio"/>
P12.07	Rotor resistor of asynchronous motor 2	0.001–65.535Ω		Depend on model	<input type="radio"/>
P12.08	Leakage inductance of asynchronous motor 2	0.1–655.35mH		Depend on model	<input type="radio"/>
P12.09	Mutual inductance of asynchronous motor 2	0.1–655.35mH		Depend on model	<input type="radio"/>
P12.10	Non-load current of asynchronous motor 2	0.1–6553.5A		Depend on model	<input type="radio"/>
P12.11	Magnetic saturation coefficient 1 for the iron core of AM2	0.0–100.0%		80.0%	<input checked="" type="radio"/>
P12.12	Magnetic saturation coefficient 2 for the iron core of AM2	0.0–100.0%		68.0%	<input checked="" type="radio"/>

Function code	Name	Detailed instruction of parameters		Default value	Modify	
P12.13	Magnetic saturation coefficient 3 for the iron core of AM2	0.0–100.0%		57.0%	⊙	
P12.14	Magnetic saturation coefficient 4 for the iron core of AM2	0.0–100.0%		40.0%	⊙	
P12.15	Rated power of synchronous motor 2	0.1–3000.0kW	<p>Set the parameter of the controlled asynchronous motor.</p> <p>In order to ensure the controlling performance, set the P12.151–P12.19 according to the name plate of the asynchronous motor.</p> <p>Goodrive300 series VFDs provide the function of parameter autotuning. Correct parameter autotuning comes from the correct setting of the motor name plate.</p> <p>In order to ensure the controlling performance, please configure the motor according to the standard principles, if the gap between the motor and the standard one is huge, the features of the VFD will decrease.</p> <p>Note: Reset the rated power of the motor (P12.15), initialize the motor parameter of P12.16–P12.19.</p>	Depend on model	⊙	
P12.16	Rated frequency of synchronous motor 2	0.01Hz–P00.03 (Max. frequency)		50.00 Hz	⊙	
P12.17	Number of poles pairs for synchronous motor 2	1–50		2	⊙	
P12.18	Rated voltage of synchronous motor 2	0–1200V		Depend on model	⊙	
P12.19	Rated current of synchronous motor 2	0.8–6000.0A		Depend on model	⊙	
P12.20	Stator resistor of synchronous motor 2	0.001–65.535Ω		Depend on model	○	
P12.21	Direct axis inductance of	0.01–655.35mH		After finish the motor parameter autotuning, the set	Depend on	○

Function code	Name	Detailed instruction of parameters		Default value	Modify
	synchronous motor 2		value of P12.20–P12.22 will renew automatically. These parameters are basic parameters controlled by vectors which directly impact the features.	model	
P12.22	Quadrature axis inductance of synchronous motor 2	0.01–655.35mH	When P00.15=1, the set value of P12.23 can be updated through autotuning automatically, and there is no need to change the value of P12.23; when P00.15=2, the set value of P12.23 cannot be updated through autotuning, please account and update the value of P12.23. Note: Users cannot modify the parameters freely.	Depend on model	○
P12.23	Back EMF constant of synchronous motor 2	When P00.15=2, the set value of P12.23 cannot be updated by autotuning, please count according to the following method. The counter-electromotive force constant can be counted according to the parameters on the name plate of the motor. There are three ways to count: 1. If the name plate designate the counter-electromotive force constant K_e , then: $E = (K_e \times n_N \times 2\pi) / 60$ 2. If the name plate designate		300	○

Function code	Name	Detailed instruction of parameters	Default value	Modify
		<p>the counter-electromotive force constant E'(V/1000r/min), then: $E = E' \times n_N / 1000$</p> <p>3. If the name plate does not designate the above parameters, then: $E = P / \sqrt{3} \times I$</p> <p>In the above formulas: n_N is the rated rotation speed, P is the rated power and I is the rated current. Setting range: 0–10000</p>		
P12.24	Initial pole position of synchronous motor 2 (reserved)	0–FFFFH (reserved)	0x0000	●
P12.25	Identification current of synchronous motor 2 (reserved)	0%–50%(the rated current of the motor) (reserved)	10%	●
P12.26	Motor 2 overload protection	0: No protection 1: Common motor(with low speed compensation) 2: Variable frequency motor (without low speed compensation)	2	◎

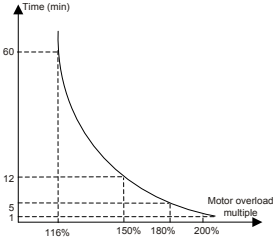
Function code	Name	Detailed instruction of parameters	Default value	Modify
P12.27	Motor 2 overload protection coefficient	<p>Times of motor overload $M = I_{out}/(I_n \times K)$</p> <p>$I_n$ is the rated current of the motor, I_{out} is the output current of the VFD and K is the motor protection coefficient.</p> <p>The smaller K is, the greater M is, and the more likely protection is implemented.</p> <p>When $M=116\%$, protection is performed after motor overload lasts for 1 hour; when $M=150\%$, protection is performed after motor overload lasts for 12 minutes; when $M=180\%$, protection is performed after motor overload lasts for 5 minutes; when $M=200\%$, protection is performed after motor overload lasts for 60 seconds; and when $M \geq 400\%$, protection is performed immediately.</p>  <p>Setting range: 20.0%–120.0%</p>	100.0%	<input type="radio"/>
P12.28	Correction coefficient of motor 2 power	<p>Correct the power displaying of motor 2.</p> <p>Only impact the displaying value other than the control performance of the VFD.</p> <p>Setting range: 0.00–3.00</p>	1.00	<input type="radio"/>
P12.29	Parameter display of motor 2	<p>0: Display according to the motor type: only the parameters corresponding to the current motor type are displayed for the convenient for the customers in this mode.</p> <p>1: All parameters are displayed: all parameters are displayed in this mode.</p>	0	<input type="radio"/>
P13 Group Synchronous motor control				
P13.00	Reduction coefficient of	0.0–100.0%	80.0%	<input checked="" type="radio"/>

Function code	Name	Detailed instruction of parameters	Default value	Modify
	source current			
P13.01	Original pole test mode	0: No test 1: High-frequency superposition (reserved) 2: Pulse superposition	0	☉
P13.02	Source current 1	Source current is the positioning current of the magnetic pole position. Source current 1 is valid under the frequency point of current shifting. Increasing the value can raise the starting torque. Setting range: 0.0%–100.0% (rated current of the motor)	20.0%	○
P13.03	Source current 2	Source current is directional current of the magnetic pole position. Source current 2 is valid under the frequency point of current shifting. There is no need to modify the value generally. Setting range: 0.0%–100.0% (rated current of the motor)	10.0%	○
P13.04	Shift frequency of source current	Valid frequency shifting point between source current 1 and current 2. Setting range: 0.00Hz–P00.03 (Max. frequency)	10.00 Hz	○
P13.05	Superposing frequency (reserved)	200–1000Hz	500Hz	☉
P13.06	Pulse superposing voltage	0.0–300.0% (rated voltage of the motor)	40.0%	☉
P13.07	Reserved	0–65535	0	○
P13.08	Control parameter 1	0–65535	0	○
P13.09	Control parameter 2	0–655.35	2.00	○
P13.10	Reserved	0–65535	0	○
P13.11	Maladjustment detection time	Adjust the response of anti-maladjustment. Bigger load inertia may increase the value, but the response will be slower. Setting range: 0.0–10.0s	0.5s	○
P13.12	High frequency	When the motor speed is faster than the rated speed, the parameter is valid, if vibration occurs	0.0%	○

Function code	Name	Detailed instruction of parameters	Default value	Modify
	compensation coefficient	to the motor, please adjust the parameter. Setting range: 0–100.0%		
P13.13	Braking current of short-circuit	When P01.00=0 during the starting of the VFD, set P13.14 to a non-zero value to enter the short circuit braking.	0.0%	<input type="radio"/>
P13.14	Braking retention time before starting	When the running frequency is lower than P01.09 during the stopping of the VFD, set 13.15 to a non-zero value to enter into stopping short circuited braking and then carry out the DC braking at the time set by P01.12 (refer to the instruction of P01.09–P01.12) .	0.00s	<input type="radio"/>
P13.15	The braking retention time when stopping	Setting range of P13.13: 0.0–150.0% (the VFD) Setting range of P13.14: 0.00–50.00s Setting range of P13.15: 0.00–50.00s	0.00s	<input type="radio"/>
P14 Group Serial communication				
P14.00	Local communication address	Setting range:1–247 When the master is writing the frame, the communication address of the slave is set to 0; the address is the communication address. All slaves on the Modbus fieldbus can receive the frame, but the slave doesn't answer. The communication of the drive is unique in the communication net. This is the fundamental for the point to point communication between the upper monitor and the drive. Note: The address of the slave cannot set to 0.	1	<input type="radio"/>
P14.01	Communication baud ratio	Set the digital transmission speed between the upper monitor and the VFD. 0: 1200BPS 1: 2400BPS 2: 4800BPS 3: 9600BPS 4: 19200BPS 5: 38400BPS 6: 57600BPS 7: 115200BPS Note: The baud rate between the upper PC and	4	<input type="radio"/>

Function code	Name	Detailed instruction of parameters	Default value	Modify
		the VFD must be the same. Otherwise, the communication is not applied. The bigger the baud rate, the quicker the communication speed.		
P14.02	Digital bit checkout	The data format between the upper monitor and the VFD must be the same. Otherwise, the communication is not applied. 0: No check (N,8,1) for RTU 1: Even check (E,8,1) for RTU 2: Odd check (O,8,1) for RTU 3: No check (N,8,2) for RTU 4: Even check (E,8,2) for RTU 5: Odd check(O,8,2) for RTU	1	○
P14.03	Answer delay	0–200ms The interval time when the drive receives the data and sent it to the upper monitor. If the answer delay is shorter than the system processing time, then the answer delay time is the system processing time, if the answer delay is longer than the system processing time, then after the system deal with the data, waits until achieving the answer delay time to send the data to the upper monitor.	5	○
P14.04	Fault time of communication overtime	0.0(invalid), 0.1–60.0s When the function code is set as 0.0, the communication overtime parameter is invalid. When the function code is set as non-zero, if the interval time between two communications exceeds the communication overtime, the system will report "485 communication faults" (CE). Generally, set it as invalid; set the parameter in the continuous communication to monitor the communication state.	0.0s	○
P14.05	Transmission fault processing	0: Alarm and stop freely 1: No alarm and continue to run 2: No alarm and stop according to the stop mode (only under the communication control) 3: No alarm and stop according to the stop mode (under all control modes)	0	○

Function code	Name	Detailed instruction of parameters	Default value	Modify
P14.06	Communication processing	0x00–0x11 LED ones: 0: Write with response: the VFD will respond to all reading and writing commands of the upper monitor. 1: Write without response: the VFD only responds to the reading command other than the writing command of the drive. The communication efficiency can be increased by this method. LED tens: 0: Communication encrypting is invalid 1: Communication encrypting is valid	0x00	○
P15 Group PROFIBUS/CANopen function				
P15.00	Module type	0: PROFIBUS 1: CANopen Select communication protocol	0	◎
P15.01	Module address	0–127 This function code is used to designate the address of the VFD. Note: 0 is the broadcast address, when set it as broadcast address, only receive the radio command of the upper monitor other than answering the upper monitor.	2	◎
P15.02	PZD2 receiving	0: Invalid	0	○
P15.03	PZD3 receiving	1: Setting frequency (0–Fmax(unit:0.01Hz))	0	○
P15.04	PZD4 receiving	2: PID reference, range (0–1000, 1000 corresponds to 100.0%)	0	○
P15.05	PZD5 receiving	3: PID feedback, range (0–1000, 1000 corresponds to 100.0%)	0	○
P15.06	PZD6 receiving	4: Torque setting (-3000–3000,1000 corresponds to 100.0% the rated current of the motor)	0	○
P15.07	PZD7 receiving	5: Upper frequency of forward rotation (0–Fmax unit:0.01Hz)	0	○
P15.08	PZD8 receiving	6: Upper frequency of reverse rotation (0–Fmax(unit:0.01Hz))	0	○
		7: Electromotion torque upper limit (0–3000,1000 corresponds to 100.0%of the rated current of the	0	○

Function code	Name	Detailed instruction of parameters	Default value	Modify
P15.09	PZD9 receiving	motor) 8: Braking torque upper limit (0–2000,1000 corresponds to 100.0% of the rated current of the motor)	0	<input type="radio"/>
P15.10	PZD10 receiving	9: Virtual input terminals command Range:0x000–0x1FF	0	<input type="radio"/>
P15.11	PZD11 receiving	10: Virtual output terminals command Range: 0x00–0x0F	0	<input type="radio"/>
P15.12	PZD12 receiving	11: Voltage setting value (special for V/F separation)(0–1000,1000 corresponds to 100.0% the rated voltage of the motor) 12: AO output set value 1 (-1000–1000, 1000 corresponds to 100.0%) 13: AO output set value 2 (-1000–1000, 1000 corresponds to 100.0%) 14–20: Reserved	0	<input type="radio"/>
P15.13	PZD2 sending	0: Invalid	0	<input type="radio"/>
P15.14	PZD3 sending	1: Running frequency (×100,Hz)	0	<input type="radio"/>
P15.15	PZD4 sending	2: Setting frequency (×100,Hz)	0	<input type="radio"/>
P15.16	PZD5 sending	3: Bus voltage (×10,V)	0	<input type="radio"/>
P15.17	PZD6 sending	4: Output voltage (×1,V)	0	<input type="radio"/>
P15.18	PZD7 sending	5: Output current (×10,A)	0	<input type="radio"/>
P15.19	PZD8 sending	6: Output torque actual value (×10,%)	0	<input type="radio"/>
P15.20	PZD9 sending	7: Output power actual value (×10,%)	0	<input type="radio"/>
P15.21	PZD10 sending	8: Running rotating speed (×1,RPM)	0	<input type="radio"/>
P15.22	PZD11 sending	9: Running linear speed (×1,m/s)	0	<input type="radio"/>
P15.23	PZD12 sending	10: Ramp frequency reference 11: Fault code 12: AI1 value (×100,V) 13: AI2 value (×100,V) 14: AI3 value (×100,V) 15: PULSE frequency value (×100,kHz) 16: Terminals input state 17: Terminals output state 18: PID given (×100,%) 19: PID feedback (×100,%) 20: Motor rated torque 21: Control word	0	<input type="radio"/>

Function code	Name	Detailed instruction of parameters	Default value	Modify
P15.24	Temporarily variable 1 for PZD sending	0-65535	0	<input type="radio"/>
P15.25	Fault tiem of DP communication overtime	0.0 (invalid),0.1-60.0s When this function code is set as 0.0, this function is invalid. When the function code is set as nonzero value, if the internal time between two adjent communications exceeds the communication overtime, the system will report "PROFIBUS communication fault" (E-DP).	0.0s	<input type="radio"/>
P15.26	Fault tiem of CANopen communication overtime	0.0(invalid), 0.1-60.0s When this function code is set as 0.0, this function is invalid. When the function code is set as nonzero value, if the internal time between two adjent communication exceeds the communication overtime, the system will report "CANopen communication fault" (E-CAN).	0.0s	<input type="radio"/>
P15.27	CANopen baud rate	0: 1000k 1: 800k 2: 500k 3: 250k 4: 125k 5: 100k 6: 50k 7: 20k	0	<input checked="" type="radio"/>
P16 Group Ethernet function				
P16.00	Speed setting of the Ethernet communication	0: Self-adapting 1: 100M full duplex 2: 100M semiduplex 3: 10M full duplex 4: 10M semiduplex The function code is used to set the Ethernet communication speed.	0	<input checked="" type="radio"/>
P16.01	IP address 1	0-255	192	<input checked="" type="radio"/>
P16.02	IP address 2	Set the IP address of Ethernet communication.	168	<input checked="" type="radio"/>

Function code	Name	Detailed instruction of parameters	Default value	Modify
P16.03	IP address 3	The format of IP address: P16.09.P16.10.P16.11.P16.12. For example: IP address is 192.168.0.1.	0	⊙
P16.04	IP address 4		1	⊙
P16.05	Subnet mask 1	0-255 Set the subnet mask of Ethernet communication. The format of IP subnet mask: P16.13.P16.14.P16.15.P16.16. For example: The mask is 255.255.255.0.	255	⊙
P16.06	Subnet mask 2		255	⊙
P16.07	Subnet mask 3		255	⊙
P16.08	Subnet mask 4		0	⊙
P16.09	Gateway 1	0-255 Set the gateway of Ethernet communication.	192	⊙
P16.10	Gateway 2		168	⊙
P16.11	Gateway 3		1	⊙
P16.12	Gateway 4		1	⊙
P17 Group Monitoring function				
P17.00	Setting frequency	Display current set frequency of the VFD. Range: 0.00Hz-P00.03	0.00Hz	●
P17.01	Output frequency	Display current output frequency of the VFD. Range: 0.00Hz-P00.03	0.00Hz	●
P17.02	Ramp reference frequency	Display current ramp given frequency of the VFD. Range: 0.00Hz-P00.03	0.00Hz	●
P17.03	Output voltage	Display current output voltage of the VFD. Range: 0-1200V	0V	●
P17.04	Output current	Display current output current of the VFD. Range: 0.0-3000.0A	0.0A	●
P17.05	Motor speed	Display the rotation speed of the motor. Range: 0-65535RPM	0 RPM	●
P17.06	Torque current	Display current torque current of the VFD. Range: -3000.0-3000.0A	0.0A	●
P17.07	Exciting current	Display current exciting current of the VFD. Range: -3000.0-3000.0A	0.0A	●
P17.08	Motor power	Display current power of the motor. Setting range: -300.0%-300.0% (the rated current of the motor)	0.0%	●

Function code	Name	Detailed instruction of parameters	Default value	Modify																				
P17.09	Output torque	Display the current output torque of the VFD. Range: -250.0–250.0%	0.0%	●																				
P17.10	Evaluated motor frequency	Evaluate the motor rotor frequency on close loop vector. Range: 0.00– P00.03	0.00Hz	●																				
P17.11	DC bus voltage	Display current DC bus voltage of the VFD. Range: 0.0–2000.0V	0.0V	●																				
P17.12	Digital input terminals state	Display current Switch input terminals state of the VFD. <table border="1" style="margin-left: 20px;"> <tr> <td></td> <td>BIT8</td> <td>BIT7</td> <td>BIT6</td> <td>BIT5</td> </tr> <tr> <td></td> <td>HDI</td> <td>S8</td> <td>S7</td> <td>S6</td> </tr> <tr> <td></td> <td>BIT4</td> <td>BIT3</td> <td>BIT2</td> <td>BIT1</td> </tr> <tr> <td></td> <td>S5</td> <td>S4</td> <td>S3</td> <td>S2</td> </tr> </table> Range: 0000–01FF		BIT8	BIT7	BIT6	BIT5		HDI	S8	S7	S6		BIT4	BIT3	BIT2	BIT1		S5	S4	S3	S2	0	●
	BIT8	BIT7	BIT6	BIT5																				
	HDI	S8	S7	S6																				
	BIT4	BIT3	BIT2	BIT1																				
	S5	S4	S3	S2																				
P17.13	Digital output terminals state	Display current Switch output terminals state of the VFD. <table border="1" style="margin-left: 20px;"> <tr> <td>BIT3</td> <td>BIT2</td> <td>BIT1</td> <td>BIT0</td> </tr> <tr> <td>RO2</td> <td>RO1</td> <td>HDO</td> <td>Y</td> </tr> </table> Range: 0000–000F	BIT3	BIT2	BIT1	BIT0	RO2	RO1	HDO	Y	0	●												
BIT3	BIT2	BIT1	BIT0																					
RO2	RO1	HDO	Y																					
P17.14	Digital adjustment	Display the adjustment through the keypad of the VFD. Range: 0.00Hz–P00.03	0.00Hz	●																				
P17.15	Torque reference	Display the torque given, the percentage to the current rated torque of the motor. Setting range: -300.0%–300.0% (the rated current of the motor)	0.0%	●																				
P17.16	Linear speed	Display the current linear speed of the VFD. Range: 0–65535	0	●																				
P17.17	Length	Display the current length of the VFD. Range: 0–65535	0	●																				
P17.18	Count value	Display the current counting number of the VFD. Range: 0–65535	0	●																				
P17.19	AI1 input voltage	Display analog AI1 input signal. Range: 0.00–10.00V	0.00V	●																				
P17.20	AI2 input voltage	Display analog AI2 input signal. Range: 0.00–10.00V	0.00V	●																				

Function code	Name	Detailed instruction of parameters	Default value	Modify
P17.21	AI3 input voltage	Display analog AI2 input signal. Range: -10.00–10.00V	0.00V	●
P17.22	HDI input frequency	Display HDI input frequency. Range: 0.000–50.000kHz	0.000 kHz	●
P17.23	PID reference	Display PID given value. Range: -100.0–100.0%	0.0%	●
P17.24	PID feedback	Display PID response value. Range: -100.0–100.0%	0.0%	●
P17.25	Power factor of the motor	Display the current power factor of the motor. Range: -1.00–1.00	0.0	●
P17.26	Current running time	Display the current running time of the VFD. Range:0–65535m	0m	●
P17.27	Simple PLC and the current step of the multi-step speed	Display simple PLC and the current stage of the multi-step speed. Range: 0–15	0	●
P17.28	ASR controller output	The percentage of the rated torque of the corresponding motor, display ASR controller output. Range: -300.0%–300.0% (the rated current of the motor)	0.0%	●
P17.29	Magnetic pole angle of SM	Display synchronous motor Magnetic pole angle. Range: 0.0–360.0	0.0	●
P17.30	Phase compensation of SM	Display synchronous motor phase compensation. Range: -180.0–180.0	0.0	●
P17.31	High-frequency superimposed current of SM	Display synchronous motor high-frequency Superimposed current. Range: 0.0%–200.0% (the rated current of the motor)	0.0	●
P17.32	Magnetic flux linkage	Display the magnetic flux linkage of the motor. Range: 0.0%–200.0%	0.0%	●
P17.33	Exciting current reference	Display the exciting current reference in the vector control mode. Range: -3000.0–3000.0A	0.0A	●
P17.34	Torque current	Display the torque current reference in the vector	0.0A	●

Function code	Name	Detailed instruction of parameters	Default value	Modify
	reference	control mode. Range: -3000.0–3000.0A		
P17.35	AC current	Display the value of inlet current in AC side. Range: 0.0–5000.0A	0.0A	●
P17.36	Output torque	Display the output torque. Positive value is in the electromotion state, and negative is in the power generating state. Range : -3000.0Nm–3000.0Nm	0.0Nm	●
P17.37	Count value of motor overload	0–100 (100 reports OL1 fault)	0	●
P17.38	PID output	-100.00–100.00%	0.00%	●
P17.39	Wrong download of parameters	0.00–99.99	0.00	●

Chapter 7 Basic operation instruction

7.1 What this chapter contains

This chapter describes the internal function modules of the VFD in details.



- Ensure that all terminals are connected properly and tightly.
- Ensure that the power of the motor corresponds to that of the VFD.

7.2 First powering on

Check before powering on

Please check according to the installation list in chapter two.

First powering operation

Check to ensure there is no mistake in wiring and power supply, switch on the air switch of the AC power supply on the input side of the VFD to power on the VFD. 8.8.8.8.8 will be displayed on the keypad, and the contactor closes normally. When the character on the nixie tube changes to the set frequency, the VFD has finished the initialization and it is in the stand-by state.

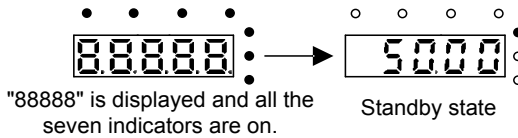

Below diagram shows the first operation: (take motor 1 as the example)

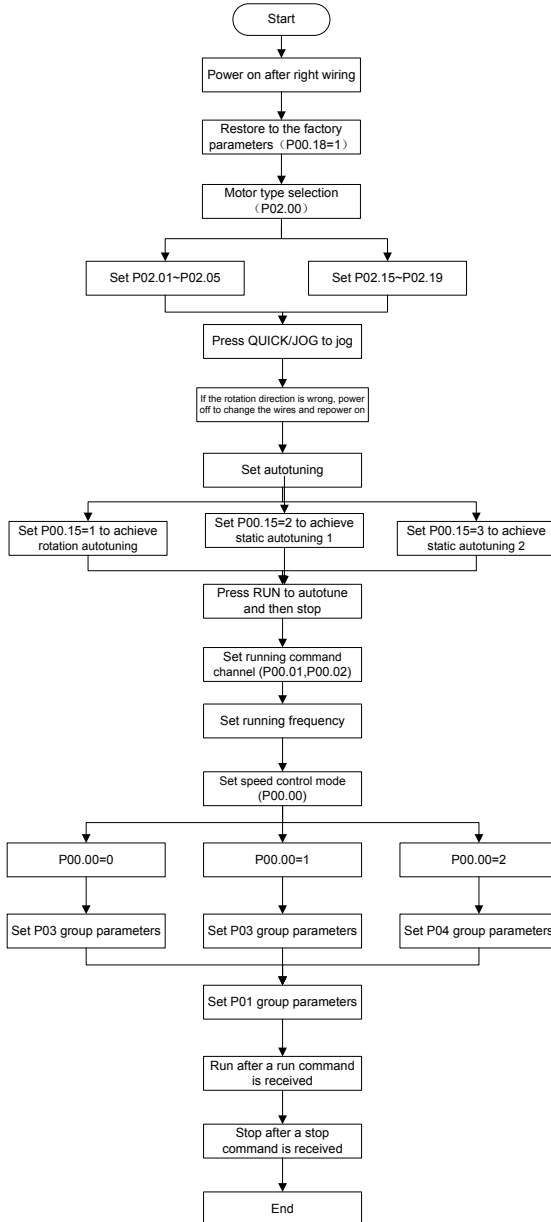

Note: If fault occurs, please do as the Chapter 8 "Fault tracking". Estimate the fault reason and settle the issue.

Besides P00.01 and P00.02, terminal command setting can also used to set the running command channel.

Current running command channel P00.01	Multi-function terminal 36 Switch to keypad	Multi-function terminal 37 Switch to terminal	Multi-function terminal 38 Switch to communication
Keypad	/	Terminal	Communication
Terminal	Keypad	/	Communication
Communication	Keypad	Terminal	/

Note: "/" means the multi-function terminal is invalid on the current given channel.

Related parameters:

Function code	Name	Detailed instruction of parameters	Default value
P00.00	Speed control mode	0: Sensorless vector control mode 0 (apply to AM and SM) 1: Sensorless vector control mode 1 (applying to AM) 2: SVPWM control	1
P00.01	Running command channel	0: Keypad 1: Terminal ("LOCAL/REMOT" flickering) 2: Communication ("LOCAL/REMOT" on)	0
P00.02	Communication running commands	0: Modbus communication channel 1: PROFIBUS\CANopen communication channel 2: Ethernet communication channel 3: Reserved	0
P00.18	Function restore parameter	0: No operation 1: Restore the default value 2: Cancel the fault record	0
P00.15	Motor parameter autotuning	0: No operation 1: Rotating autotuning 2: Static autotuning 1 (autotune totally) 3: Static autotuning 2 (autotune part parameters)	0
P02.00	Motor type 1	0: Asynchronous motor 1: Synchronous motor	0
P02.01	Rated power of asynchronous motor 1	0.1–3000.0kW	Depend on model

Function code	Name	Detailed instruction of parameters	Default value
P02.02	Rated frequency of asynchronous motor 1	0.01Hz–P00.03 (Max. output frequency)	50.00Hz
P02.03	Rated speed of asynchronous motor 1	1–36000rpm	Depend on model
P02.04	Rated voltage of asynchronous motor 1	0–1200V	Depend on model
P02.05	Rated current of asynchronous motor 1	0.8–6000.0A	Depend on model
P02.15	Rated power of synchronous motor 1	0.1–3000.0kW	Depend on model
P02.16	Rated frequency of synchronous motor 1	0.01Hz–P00.03 (Max. frequency)	50.00Hz
P02.17	Number of poles pairs for synchronous motor 1	1–50	2
P02.18	Rated voltage of synchronous motor 1	0–1200V	Depend on model
P02.19	Rated current of synchronous motor 1	0.8–6000.0A	Depend on model
P05.01–P05.09	Multi-function digital input terminals (S1–S8,HDI) function selection	36: Shift the command to keypad 37: Shift the command to terminals 38: Shift the command to communication	
P07.01	Parameter copy	The function code determines the manner of parameters copy. 0: No operation 1: Upload the local function parameter to the keypad 2: Download the keypad function parameter to local address (including the motor parameters) 3: Download the keypad function parameter to local address (excluding the motor parameter of P02 and P12 group) 4: Download the keypad function parameters to local address (only for the motor parameter of P02 and P12 group)	0
P07.02	QUICK/JOG function	0: No function	1

Function code	Name	Detailed instruction of parameters	Default value
	selection	1: Jogging 2: Shift the display state by the shifting key 3: Shift between forward rotations and reverse rotations 4: Clear UP/DOWN settings 5: Coast to stop 6: Shift the given manner of running commands 7: Quick commission mode (committee according to the non-factory parameter)	

7.3 Vector control

Because asynchronous motors have the characteristics of high stage, nonlinear, strong coupling and various variables, the actual control of the asynchronous motor is very difficult. Vector control is mainly used to settle this problem with the theme of that divide the stator current vector into exciting current (the current heft generating internal magnetic field of the motor) and torque current (the current heft generating torque) by controlling and measuring the stator current vector according to the principles of beamed magnetic field to control the range and phase of these two hefts. This method can realize the decoupling of exciting current and torque current to adjust the high performance of asynchronous motors.

Goodrive300 series VFDs are embedded speedless sensor vector control calculation for driving both asynchronous motors and synchronous motors. Because the core calculation of vector control is based on exact motor parameter models, the accuracy of motor parameter will impact on the performance of vector control. It is recommended to input the motor parameters and carry out autotune before vector running.

Because the vector control calculation is vary complicated, high technical theory is needed for the user during internal autotune. It is recommended to use the specific function parameters in vector control with cautions.

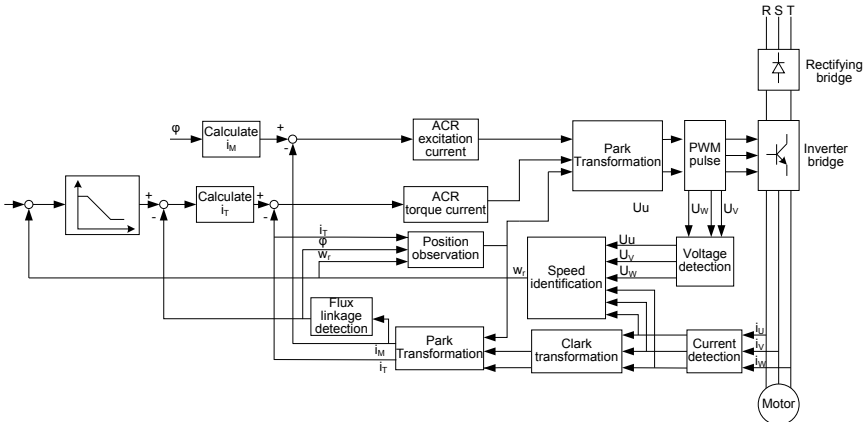

Function code	Name	Detailed instruction of parameters	Default value
P00.00	Speed control mode	0: Sensorless vector control mode 0 (apply to AM and SM) 1: Sensorless vector control mode 1 (applying to AM) 2: SVPWM control	1
P00.15	Motor parameter autotuning	0: No operation 1: Rotating autotuning 2: Static autotuning 1 (autotune all motor parameters) 3: Static autotuning 2 (autotune some of the motor parameters)	0
P02.00	Type of motor 1	0: Asynchronous motor 1: Synchronous motor	0
P03.00	Speed loop proportional gain1	0–200.0	20.0
P03.01	Speed loop integral time1	0.000–10.000s	0.200s
P03.02	Low switching frequency	0.00Hz–P03.05	5.00Hz
P03.03	Speed loop proportional gain 2	0–200.0	20.0
P03.04	Speed loop integral time 2	0.000–10.000s	0.200s
P03.05	High switching frequency	P03.02–P00.03 (Max. frequency)	10.00Hz
P03.06	Speed loop output filter	0–8 (corresponding to 0–2 ⁶ /10ms)	0

Function code	Name	Detailed instruction of parameters	Default value
P03.07	Compensation coefficient of electromotion slip in vector control	50%–200%	100%
P03.08	Compensation coefficient of braking slip in vector control	50%–200%	100%
P03.09	Current loop proportional coefficient P	0–65535	1000
P03.10	Current loop integral coefficient I	0–65535	1000
P03.11	Torque setting method	<p>This parameter is used to enable the torque control mode, and set the torque.</p> <p>0: Torque control is invalid 1: Keypad setting torque (P03.12) 2: Analog AI1 setting torque 3: Analog AI2 setting torque 4: Analog AI3 setting torque 5: Pulse frequency HDI setting torque 6: Multi-step torque setting 7: Modbus communication setting torque 8: PROFIBUS/CANopen communication setting torque 9: Ethernet communication setting torque 10: Reserved</p> <p>Note: For setting modes of 2–10, 100% corresponds to three times of the rated current of the motor.</p>	0
P03.12	Keypad setting torque	-300.0%–300.0% (rated current of the motor)	50.0%
P03.13	Torque reference filter time	0.000–10.000s	0.010s
P03.14	Upper frequency of forward rotation in torque control	0: Keypad (P03.16 sets P03.14, P03.17 sets P03.15)	0
P03.15	Upper frequency of reverse rotation in torque control	1: AI1 2: AI2 3: AI3	0

Function code	Name	Detailed instruction of parameters	Default value
		4: Pulse frequency HDI 5: Multi-step 6: Modbus communication 7: PROFIBUS/CANopen communication 8: Ethernet communication 9: Reserved Note: For setting modes of 1–9, 100% corresponds to the maximum frequency.	
P03.16	Keypad setting for upper frequency of forward rotation in torque control	Setting range: 0.00Hz–P00.03 (Max. output frequency)	50.00Hz
P03.17	Keypad setting for upper frequency of reverse rotation in torque control		50.00Hz
P03.18	Upper electromotion torque limit setting SOURCE	0: Keypad (P03.20 sets P03.18, P03.21 sets P03.19) 1: AI1 2: AI2 3: AI3 4: HDI 5: Modbus communication 6: PROFIBUS/CANopen communication 7: Ethernet communication 8: Reserved Note: For setting modes of 1–8, 100% corresponds to three times of the motor current.	0
P03.19	Upper braking torque limit setting SOURCE		0
P03.20	Keypad setting of electromotion torque	0.0–300.0% (rated current of the motor)	180.0%
P03.21	Keypad setting of braking torque		180.0%
P03.22	Weakening coefficient in constant power zone	0.1–2.0	0.3
P03.23	Lowest weakening point in constant power zone	10%–100%	20%

Function code	Name	Detailed instruction of parameters	Default value
P03.24	Max. voltage limit	0.0–120.0%	100.0%
P03.25	Pre-exciting time	0.000–10.000s	0.300s
P17.32	Magnetic flux linkage	0.0–200.0%	0

7.4 SVPWM control

Goodrive300 series VFDs provide internal SVPWM control which can be used in the cases where it does not need high control accuracy. It is also recommended to use SVPWM control when one VFD drives multiple motors.

Goodrive300 series VFDs provide multiple V/F curve modes. The user can select the corresponding V/F curve according to the site needs or their own needs.

Recommendations:

For the load of constant torque, such as the conveyor belt which runs linearly. It is properly to select linear V/F curve because it needs constant torque.

For the load of decreasing torque, such as fans and water pumps, it is properly to select corresponding 1.3th, 1.7th or 2th power of V/F curve because the actual torque is 2-squared or 3-squared of the rotating speed.

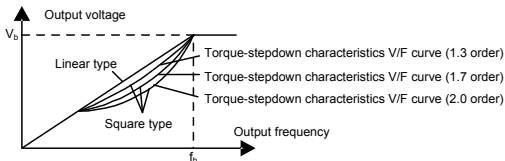

Goodrive300 series VFDs provide multi-dots V/F curve, the user can change the output V/F curve by setting the voltage and frequency of three middle dots. The whole curve is consisted of 5 dots. The starting dot is (0Hz, 0V), and the ending dot is (the basic frequency of the motor, the rated voltage of the motor). During the setting processing: $0 \leq f_1 \leq f_2 \leq f_3 \leq$ the basic frequency of the motor; $0 \leq V_1 \leq V_2 \leq V_3 \leq$ the rated voltage of the motor.

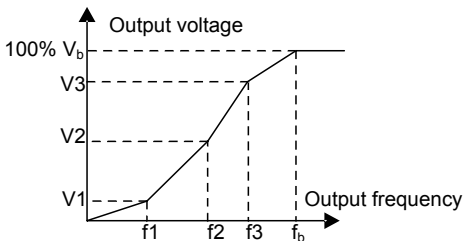

Goodrive300 series VFDs provide special function code for SVPWM control mode which can improve the performance of SVPWM control by means of setting.

1. Torque boost

Torque boost function can compensate the performance of low speed torque during SVPWM control. The VFD will adjust the torque boost according to the actual load.

Note:

The torque boost takes effect only when the frequency is under the cap frequency of the boost.

If the torque boost is too big, low frequency vibration or overcurrent fault may occur. Please lower the torque boost.

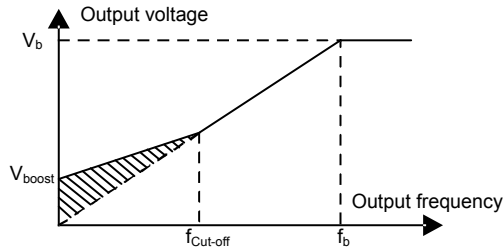

2. Energy-saving running

In the actual operation, the VFD can search by itself to achieve a better effect point. The VFD can work with high effect to save energy.

Note:

This function is usually used in the cases where the load is light or empty.

If the load transients frequently, this function is not appropriate to be selected.

3. V/F slips compensation gain

SVPWM control belongs to the open loop mode. If the load of the motor transients suddenly, the fluctuation of the rotation speed may occur. In the cases where the high accuracy speed is needed, slip compensation gain (internal output adjustment) can be set to compensate the speed change caused by load fluctuation.

Setting range of slip compensation gain: 0–200%, of which 100% corresponds to the rated slip frequency.

Note: Rated slip frequency= (rated synchronous rotation speed of the motor-rated rotation speed of the motor) × number of pole pairs/60.

4. Vibration control

Motor vibration occurs frequently when applying SVPWM control mode in the cases where high power is needed. In order to settle this problem, Goodrive300 series VFDs add two function codes which are set to control the vibration factors. The user can set the corresponding function code according to the vibration frequency.

Note: Bigger the set value, more effective the control. If the set value is too big, overcurrent may occur to the motor.

5. User-defined V/F curve (V/F seperation) function

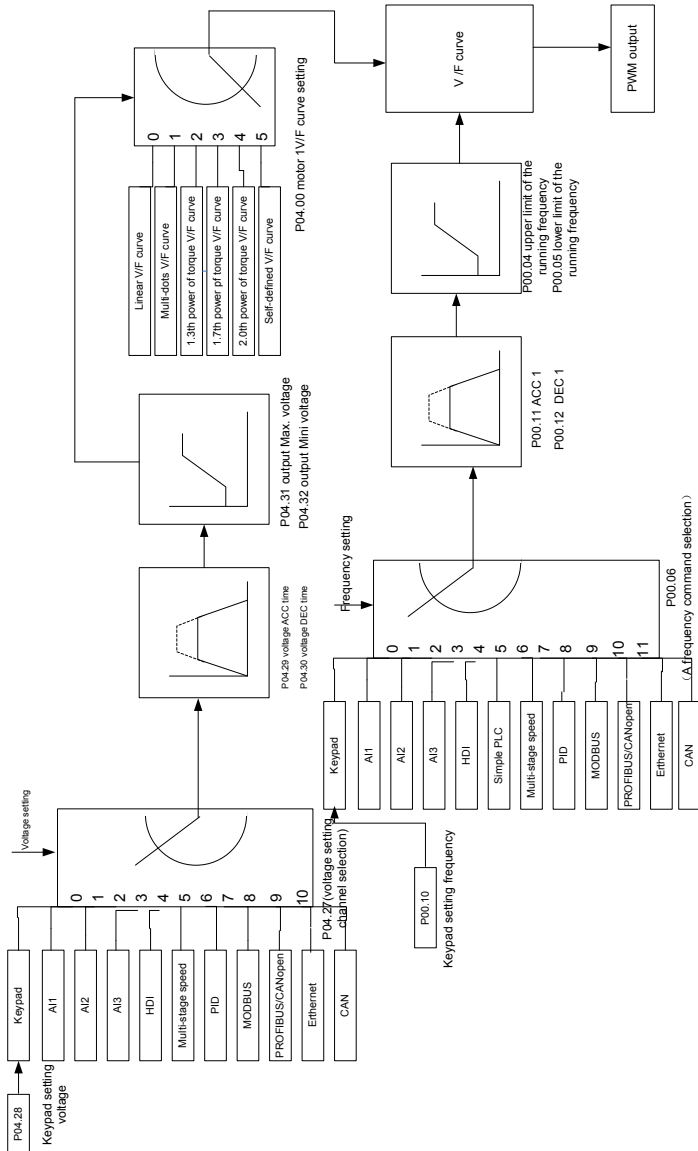

When the user selects the user-defined V/F curve function in Goodrive300 series VFDs, they can set the given channel of voltage and frequency and the corresponding ACC/DEC time, or the two can combine to form a real-time curve.

Note: the application of V/F curve separation can be used in many cases with various kinds of power supply of the VFD. But the users should set and adjust the parameters with caution. Incorrect parameters may cause damage to the VFD.

Function code	Name	Description	Default value
P00.00	Speed control mode	0: Sensorless vector control mode 0 (applicable to AM and SM) 1: Sensorless vector control mode 1 (applicable to AM) 2: SVPWM control mode (applicable to AM and SM)	1
P00.03	Max. output frequency	P00.04–400.00Hz	50.00Hz
P00.04	Upper limit of the running frequency	P00.05–P00.03	50.00Hz
P00.05	Lower limit of the running frequency	0.00Hz–P00.04	0.00Hz
P00.11	ACC time 1	0.0–3600.0s	Depend on model
P00.12	DEC time 1	0.0–3600.0s	Depend on model
P02.00	Type of motor 1	0: Asynchronous motor 1: Synchronous motor	0
P02.02	Rated frequency of asynchronous motor 1	0.01Hz–P00.03 (Max. output frequency)	50.00Hz
P02.04	Rated voltage of asynchronous motor 1	0–1200V	Depend on model
P04.00	Motor 1 V/F curve setting	0: Straight line V/F curve 1: Multi-dots V/F curve 2: 1.3 th power low torque V/F curve 3: 1.7 th power low torque V/F curve 4: 2.0 th power low torque V/F curve 5: Customized V/F (V/F separation)	0
P04.01	Torque boost of motor 1	0.0%: (automatic) 0.1%–10.0%	0.0%
P04.02	Torque boost close of motor 1	0.0%–50.0% (rated frequency of motor 1)	20.0%
P04.03	V/F	0.00Hz–P04.05	0.00Hz

Function code	Name	Description	Default value
	frequency 1 of motor 1		
P04.04	V/F voltage 1 of motor 1	0.0%–110.0%	0.0%
P04.05	V/F frequency 2 of motor 1	P04.03– P04.07	00.00Hz
P04.06	V/F voltage 2 of motor 1	0.0%–110.0%	0.0%
P04.07	V/F frequency 3 of motor 1	P04.05–P02.02 or P04.05–P02.16	00.00Hz
P04.08	V/F voltage 3 of motor 1	0.0%–110.0%	0.0%
P04.09	V/F slip compensation gain of motor 1	0.0–200.0%	100.0%
P04.10	Vibration control factor at low frequency of motor 1	0–100	10
P04.11	Vibration control factor at high frequency of motor 1	0–100	10
P04.12	Vibration control threshold of motor 1	0.00Hz–P00.03 (Max. output frequency)	30.00 Hz
P04.13	Motor 2 V/F curve setting	0: Straight line V/F curve; applying to the constant torque load 1: Multi-dots V/F curve 2: 1.3 th power low torque V/F curve 3: 1.7 th power low torque V/F curve 4: 2.0 th power low torque V/F curve 5: Customized V/F (V/F separation)	0
P04.14	Torque boost of motor 2	0.0%: (automatic) 0.1%–10.0%	0.0%
P04.15	Torque boost close of motor 2	0.0%–50.0% (rated frequency of motor 1)	20.0%
P04.16	V/F frequency 1 of motor 2	0.00Hz–P04.05	0.00Hz
P04.17	V/F voltage 1 of motor 2	0.0%–110.0%	0.0%
P04.18	V/F frequency 2 of motor 2	P04.16– P04.20	0.00Hz
P04.19	V/F voltage 2 of motor 2	0.0%–110.0%	0.0%

Function code	Name	Description	Default value
P04.20	V/F frequency 3 of motor 2	P04.18– P02.02 or P04.18– P02.16	0.00Hz
P04.21	V/F voltage 3 of motor 2	0.0%–110.0%	0.0%
P04.22	V/F slip compensation gain of motor 2	0.0–200.0%	100.0%
P04.23	Vibration control factor at low frequency of motor 2	0–100	10
P04.24	Vibration control factor at high frequency of motor 2	0–100	10
P04.25	Vibration control threshold of motor 2	0.00Hz–P00.03 (Max. frequency)	30.00 Hz
P04.26	Energy-saving operation	0: No action 1: Automatic energy-saving running	0
P04.27	Voltage setting	0: Keypad: the output voltage is determined by P04.28. 1: AI1 2: AI2 3: AI3 4: HDI 5: Multi-step speed 6: PID; 7: Modbus communication; 8: PROFIBUS/CANopen communication; 9: Ethernet communication (reserved) 10: Reserved	0
P04.28	Keypad setting voltage	0.0%–100.0% (rated voltage of the motor)	100.0%
P04.29	Voltage increasing time	0.0–3600.0s	5.0s
P04.30	Voltage decreasing time	0.0–3600.0s	5.0s
P04.31	Max. output voltage	P04.32–100.0% (rated voltage of the motor)	100.0%
P04.32	Min. output voltage	0.0%–P04.31 (rated voltage of the motor)	0.0%

7.5 Torque control

Goodrive300 series VFDs support two kinds of control mode: torque control and rotation speed control. The core of rotation speed is that the whole control focuses on the stable speed and ensures the setting speed is the same as the actual running speed. The Max. Load could be in the range of

Function code	Name	Detailed instruction of parameters	Default value
P00.00	Speed control mode	0: Sensorless vector control mode 0 (applicable to AM and SM) 1: Sensorless vector control mode 1 (applicable to AM) 2: SVPWM control mode (applicable to AM and SM)	1
P03.11	Torque setting method	0: Torque control is invalid 1: Keypad setting torque (P03.12) 2: Analog AI1 setting torque 3: Analog AI2 setting torque 4: Analog AI3 setting torque 5: Pulse frequency HDI setting torque 6: Multi-step torque setting 7: Modbus communication setting torque 8: PROFIBUS\CANopen communication setting torque 9: Ethernet communication setting torque 10: Reserved	0
P03.12	Keypad setting torque	-300.0%~300.0% (rated current of the motor)	50.0%
P03.13	Torque reference filter time	0.000~10.000s	0.010s
P03.14	Upper frequency of forward rotation in vector control	0: Keypad (P03.16 sets P03.14, P03.17 sets P03.15) 1: AI1	0
P03.15	Upper frequency of reverse rotation in vector control	2: AI2 3: AI3 4: Pulse frequency HDI setting upper-limit frequency 5: Multi-step setting upper-limit frequency 6: Modbus communication setting upper-limit frequency 7: PROFIBUS\CANopen communication setting upper-limit frequency 8: Ethernet communication setting upper-limit frequency	0

Function code	Name	Detailed instruction of parameters	Default value
		9: Reserved	
P03.16	Keypad setting for upper frequency of forward rotation in torque control	0.00Hz–P00.03 (Max. frequency)	50.00 Hz
P03.17	Keypad setting for upper frequency of reverse rotation in torque control	0.00 Hz–P00.03 (Max. frequency)	50.00 Hz
P03.18	Upper electromotion torque limit setting source	0: Keypad setting upper-limit frequency (P03.20 sets P03.18, P03.21 sets P03.19) 1: AI1 2: AI2	0
P03.19	Upper braking torque limit setting source	3: AI3 4: HDI 5: Modbus communication 6: PROFIBUS/CANopen communication 7: Ethernet communication 8: Reserved	0
P03.20	Keypad setting of upper electromotion torque limit	0.0–300.0% (rated current of the motor)	180.0%
P03.21	Keypad setting of upper braking torque limit	0.0–300.0% (rated current of the motor)	180.0%
P17.09	Output torque	-250.0–250.0%	0.0%
P17.15	Torque reference	-300.0–300.0% (rated current of the motor)	0.0%

7.6 Parameters of the motor

	<ul style="list-style-type: none"> Physical accident may occur if the motor starts up suddenly during autotune. Please check the safety of surrounding environment of the motor and the load before autotune. The power is still applied even the motor stops running during static autotune. Please do not touch the motor until the autotune is completed, otherwise there would be electric shock.
---	---



- Do not carry out the rotation autotune if the motor is coupled with the load, please do not operate on the rotation autotune. Otherwise misaction or damage may occur to the VFD or the mechanical devices. When carry out autotune on the motor which is coupled with load, the motor parameter won't be counted correctly and misaction may occur. It is proper to de-couple the motor from the load during autotune when necessary.

Goodrive300 series VFDs can drive both asynchronous motors and synchronous motors. And at the same time, they can support two sets of motor parameters which can shift between two motors through multi-function digital input terminal or communication.

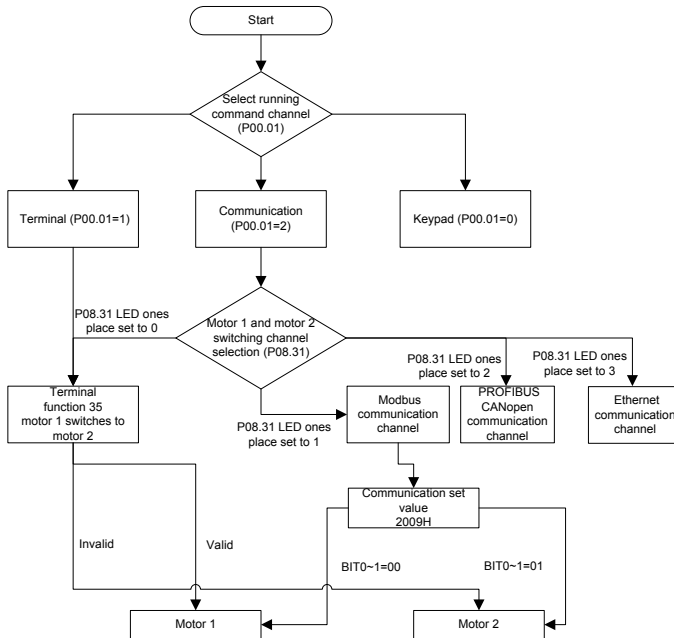

The control performance of the VFD is based on the established accurate motor model. The user has to carry out the motor autotune before first running (take motor 1 as an example).

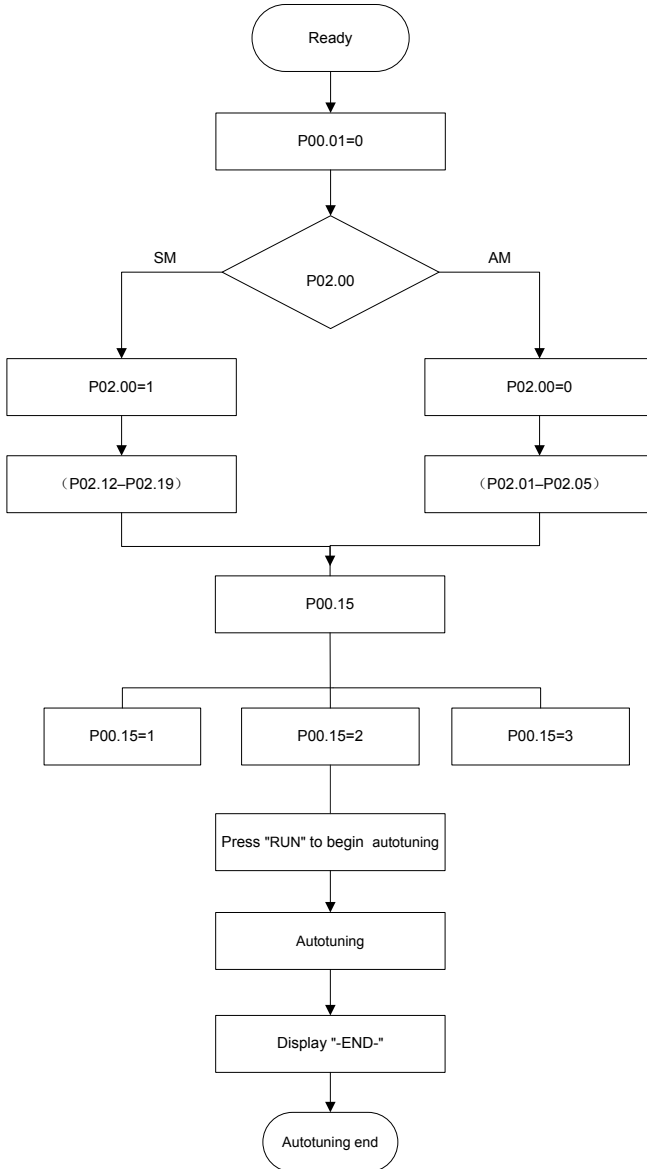

Note:

1. Set the motor parameters according to the name plate of the motor.
2. During the motor autotune, de-couple the motor from the load if rotation autotune is selected to

make the motor is in a static and empty state, otherwise the result of autotune is incorrect. The asynchronous motors can autotune the parameters of P02.06–P02.10, while the synchronous motors can autotune the parameters of P02.20–P02.23.

3. During the motor autotune, do not to de-couple the motor form the load if static autotune is selected. Because only some parameters of the motor are involved, the control performance is not as better as the rotation autotune. The asynchronous motors can autotune the parameters of P02.06–P02.10, while the synchronous motors can autotune the parameters of P02.20–P02.22. P02.23 (synchronous motor 1 counter-electromotive force constant) can be counted to attain.

4. Motor autotune only involves the current motor. Switch the motor through P08.31 to carry out the autotune on the other motor.

Related parameters

Function code	Name	Detailed instruction of parameters	Default value
P00.01	Running command channel	0: Keypad 1: Terminal ("LOCAL/REMOT" flickering) 2: Communication ("LOCAL/REMOT" on)	0
P00.15	Motor parameter autotuning	0: No operation 1: Rotating autotuning 2: Static autotuning 1 (autotune totally) 3: Static autotuning 2 (autotune part parameters)	0
P02.00	Type of motor 1	0: Asynchronous motor 1: Synchronous motor	0
P02.01	Rated power of asynchronous motor 1	0.1–3000.0kW	Depend on model
P02.02	Rated frequency of asynchronous motor 1	0.01Hz–P00.03 (Max. output frequency)	50.00Hz
P02.03	Rated speed of asynchronous motor 1	1–36000rpm	Depend on model
P02.04	Rated voltage of asynchronous motor 1	0–1200V	Depend on model
P02.05	Rated current of asynchronous motor 1	0.8–6000.0A	Depend on model
P02.06	Stator resistor of asynchronous motor 1	0.001–65.535Ω	Depend on model
P02.07	Rotor resistor of asynchronous motor 1	0.001–65.535Ω	Depend on model

Function code	Name	Detailed instruction of parameters	Default value
P02.08	Leakage inductance of asynchronous motor 1	0.1–6553.5mH	Depend on model
P02.09	Mutual inductance of asynchronous motor 1	0.1–6553.5mH	Depend on model
P02.10	Non-load current of asynchronous motor 1	0.1–6553.5A	Depend on model
P02.15	Rated power of synchronous motor 1	0.1–3000.0kW	Depend on model
P02.16	Rated frequency of synchronous motor 1	0.01Hz–P00.03 (Max. frequency)	50.00Hz
P02.17	Number of poles pairs for synchronous motor 1	1–50	2
P02.18	Rated voltage of synchronous motor 1	0–1200V	Depend on model
P02.19	Rated current of synchronous motor 1	0.8–6000.0A	Depend on model
P02.20	Stator resistor of synchronous motor 1	0.001–65.535Ω	Depend on model
P02.21	Direct axis inductance of synchronous motor 1	0.01–655.35mH	Depend on model
P02.22	Quadrature axis inductance of synchronous motor 1	0.01–655.35mH	Depend on model
P02.23	Back EMF constant of synchronous motor 1	0–10000	300
P05.01–P05.09	Multi-function digital input terminals (S1–S8, HDI) function selection	35: Shift from motor 1 to motor 2	
P08.31	Motor shifting	LED ones: shifting channel 0: terminal shifting 1: Modbus communication shifting 2: PROFIBUS/CANopen communication shifting 3: Ethernet communication shifting 4: Reserved LED tens: shifting enabling in operation	00

Function code	Name	Detailed instruction of parameters	Default value
		0: Disabled 1: Enabled 0x00–0x14	
P12.00	Motor type 2	0: Asynchronous motor 1: Synchronous motor	0
P12.01	Rated power of asynchronous motor 2	0.1–3000.0kW	Depend on model
P12.02	Rated frequency of asynchronous motor 2	0.01Hz–P00.03 (Max. frequency)	50.00Hz
P12.03	Rated speed of asynchronous motor 2	1–36000rpm	Depend on model
P12.04	Rated voltage of asynchronous motor 2	0–1200V	Depend on model
P12.05	Rated current of asynchronous motor 2	0.8–6000.0A	Depend on model
P12.06	Stator resistor of asynchronous motor 2	0.001–65.535Ω	Depend on model
P12.07	Rotor resistor of asynchronous motor 2	0.001–65.535Ω	Depend on model
P12.08	Leakage inductance of asynchronous motor 2	0.1–6553.5mH	Depend on model
P12.09	Mutual inductance of asynchronous motor 2	0.1–6553.5mH	Depend on model
P12.10	Non-load current of asynchronous motor 2	0.1–6553.5A	Depend on model
P12.15	Rated power of synchronous motor 2	0.1–3000.0kW	Depend on model
P12.16	Rated frequency of synchronous motor 2	0.01Hz–P00.03 (Max. frequency)	50.00Hz
P12.17	Number of poles pairs for synchronous motor 2	1–50	2
P12.18	Rated voltage of synchronous motor 2	0–1200V	Depend on model
P12.19	Rated current of synchronous motor 2	0.8–6000.0A	Depend on model
P12.20	Stator resistor of synchronous motor 2	0.001–65.535Ω	Depend on model

Function code	Name	Detailed instruction of parameters	Default value
P12.21	Direct axis inductance of synchronous motor 2	0.01–655.35mH	Depend on model
P12.22	Quadrature axis inductance of synchronous motor 2	0.01–655.35mH	Depend on model
P12.23	Back EMF constant of synchronous motor 2	0–10000	300

7.7 Start-up and stop control

The start-up and stop control of the VFD includes three states: start after the running command during normal powering on, start after the restarting function becomes valid during normal powering on and start after the automatic fault reset. Below is the detailed instruction for three startings.

There are three starting methods for the VFD: start from the starting frequency directly, start after the AC braking and start after the rotation speed tracking. The user can select according to different situations to meet their needs.

For the load with big inertia, especially in the cases where the reverse rotation may occur, it is better to select starting after DC braking and then starting after rotation speed tracking.

Note: it is recommended to use the direct starting to drive synchronous motor.

1. The starting logic figure of starting after the running command during the normal powering on.

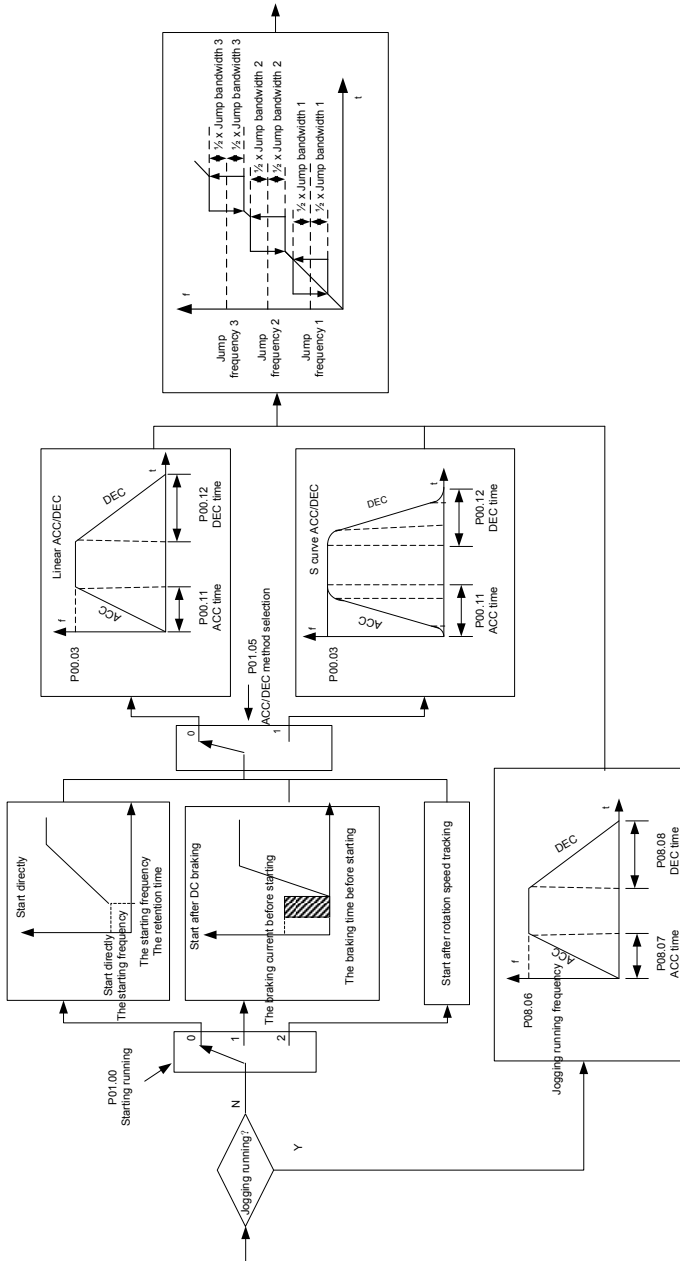

2. The starting logic figure of starting after the restarting function becomes valid during the normal powering on.

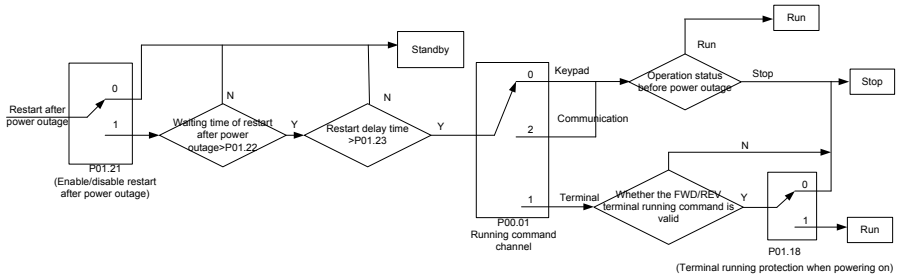

3. The starting logic figure of starting after the automatic fault reset.

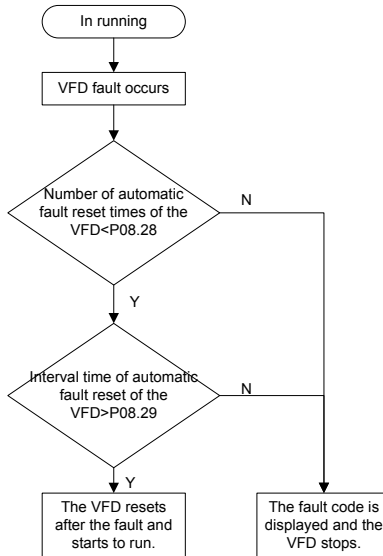

Related parameters

Function code	Name	Detailed instruction of parameters	Default value
P00.01	Running command channel	0: Keypad 1: Terminal ("LOCAL/REMOTE" flickering) 2: Communication ("LOCAL/REMOTE" on)	0
P00.11	ACC time 1	0.0–3600.0s	Depend on model

Function code	Name	Detailed instruction of parameters	Default value
P00.12	DEC time 1	0.0–3600.0s	Depend on model
P01.00	Start mode	0: Start-up directly 1: Start-up after DC braking 2: Start-up after rotation speed tracking 1	0
P01.01	Starting frequency of direct start	0.00–50.00Hz	0.50Hz
P01.02	Retention time of the starting frequency	0.0–50.0s	0.0s
P01.03	The braking current before starting	0.0–100.0%	0.0%
P01.04	The braking time before starting	0.00–50.00s	0.00s
P01.05	ACC/DEC selection	0: Linear type 1: Reserved	0
P01.08	Stop mode	0: Decelerate to stop 1: Coast to stop	0
P01.09	Starting frequency of DC braking	0.00Hz–P00.03 (Max. output frequency)	0.00Hz
P01.10	Waiting time of DC braking	0.00–50.00s	0.00s
P01.11	DC braking current	0.0–100.0%	0.0%
P01.12	DC braking time	0.00–50.00s	0.00s
P01.13	Dead time of FWD/REV rotation	0.0–3600.0s	0.0s
P01.14	Shifting between FWD/REV rotation	Set the threshold point of the VFD: 0: Switch after 0 frequency 1: Switch after the starting frequency 2: Switch after the speed reached P01.15 and delay of P01.24.	0
P01.15	Stopping speed	0.00–100.00Hz	0.50 Hz
P01.16	Detection of stopping speed	0: Speed setting (the only detection method in SVPWM mode) 1: Speed detecting value	1
P01.18	Terminal running protection when powering on	0: The terminal running command is invalid when powering on 1: The terminal running command is	0

Function code	Name	Detailed instruction of parameters	Default value
		valid when powering on	
P01.19	Action if running frequency<lower limit frequency (valid when lower limit>0)	0: Run at the lower-limit frequency 1: Stop 2: Hibernation	0
P01.20	Hibernation restore delay time	0.0–3600.0s (valid when P01.19=2)	0.0s
P01.21	Restart after power outage	0: Disable 1: Enable	0
P01.22	Waiting time of restart after power outage	0.0–3600.0s (valid when P01.21=1)	1.0s
P01.23	Start delay time	0.0–60.0s	0.0s
P01.24	Delay time of the stop speed	0.0–100.0s	0.0s
P05.01–P05.09	Digital input function selection	1: Forward rotation operation 2: Reverse rotation operation 4: Forward rotation jogging 5: Reverse rotation jogging 6: Coast to stop 7: Fault reset 8: Operation pause 21: ACC/DEC time option 1 22: ACC/DEC time option 2 30: ACC/DEC prohibition	
P08.06	Jogging frequency	0.00Hz–P00.03 (Max. frequency)	5.00Hz
P08.07	Jogging ACC time	0.0–3600.0s	Depend on model
P08.08	Jogging DEC time	0.0–3600.0s	Depend on model
P08.00	ACC time 2	0.0–3600.0s	Depend on model
P08.01	DEC time 2	0.0–3600.0s	Depend on model
P08.02	ACC time 3	0.0–3600.0s	Depend on model
P08.03	DEC time 3	0.0–3600.0s	Depend on model

Function code	Name	Detailed instruction of parameters	Default value
P08.04	ACC time 4	0.0–3600.0s	Depend on model
P08.05	DEC time 4	0.0–3600.0s	Depend on model
P08.28	Automatic fault reset times	0–10	0
P08.29	Interval time of automatic fault reset	0.1–3600.0s	1.0s

7.8 Frequency setting

Goodrive300 series VFDs can set the frequency by various means. The given channel can be divided into main given channel and assistant given channel.

There are two main given channels: A frequency given channel and B frequency given channel. These two given channels can carry out mutual simple math calculation between each other. And the given channels can be shifted dynamically through set multi-function terminals.

There are three assistant given channels: keypad UP/DOWN input, terminals UP/DOWN switch input and digital potentiometer input. The three ways equal to the effect of input UP/DOWN given in internal assistant given of the VFD. The user can enable the given method and the effect of the method to the frequency given by setting function codes.

The actual given of the VFD is consisted of main given channel and assistant given channel.

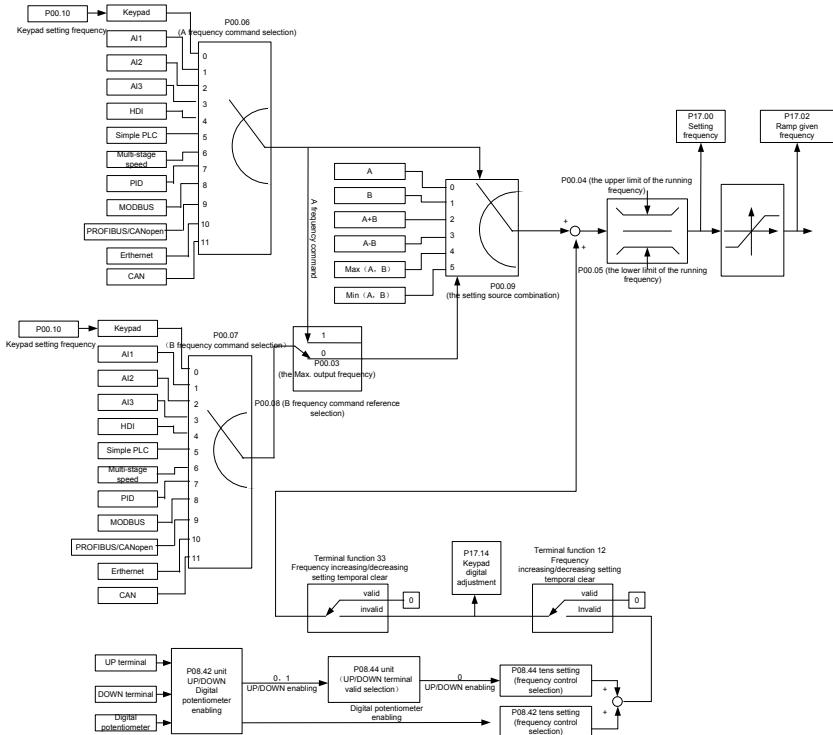

Goodrive300 series VFDs support the shifting between different given channels, and the detailed shifting rules are as below:

Current given channel P00.09	Multi-function terminal function 13 Switch from A channel to B channel	Multi-function terminal function 14 Switch from combination setting to A channel	Multi-function terminal function 15 Switch from combination setting to B channel
A	B	/	/
B	A	/	/
A+B	/	A	B
A-B	/	A	B
Max(A,B)	/	A	B
Min(A,B)	/	A	B

Note: "/" means the multi-function terminal is invalid under the current given channel.

When select multi-function terminal UP (10) and DOWN (11) to set the internal assistant frequency, P08.44 and P08.45 can be set to increase or decrease the set frequency quickly.

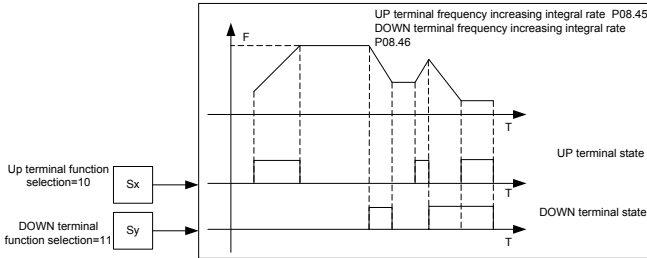

Related parameters

Function code	Name	Detailed instruction of parameters	Default value
P00.03	Max. output frequency	P00.04–400.00Hz	50.00Hz
P00.04	Upper limit of the running frequency	P00.05–P00.03	50.00Hz
P00.05	Lower limit of the running frequency	0.00Hz–P00.04	0.00Hz
P00.06	A frequency command	0: Keypad	0
P00.07	B frequency command	1: AI1 2: AI2 3: AI3 4: High-speed pulse HDI 5: Simple PLC program 6: Multi-step speed running 7: PID control 8: Modbus communication 9: PROFIBUS/CANopen communication 10: Ethernet communication 11: Reserved	0
P00.08	B frequency command reference	0: Max. output frequency 1: A frequency command	0
P00.09	Combination of setting sources	0: A 1: B 2: (A+B) combination 3: (A-B) combination 4: Max(A,B) combination 5: Min(A,B) combination	0
P05.01–P0	Multi-function digital input	10: Increasing frequency setting (UP)	

Function code	Name	Detailed instruction of parameters	Default value
5.09	terminals (S1–S8, HDI) function selection	11: Decreasing frequency setting (DOWN) 12: Cancel the frequency change setting 13: Shift between A setting and B setting 14: Shift between combination setting and A setting 15: Shift between combination setting and B setting	
P08.42	Keypad data control	0x000–0x1223 LED ones: frequency enable selection 0: Both \wedge / \vee keys and digital potentiometer adjustments are valid 1: Only \wedge/\vee keys adjustment is valid 2: Only digital potentiometer adjustments is valid 3: Neither \wedge / \vee keys nor digital potentiometer adjustments are valid LED tens: frequency control selection 0: Only valid when P00.06=0 or P00.07=0 1: Valid for all frequency setting manner 2: Invalid for multi-step speed when multi-step speed has the priority LED hundreds: action selection during stopping 0: Setting is valid 1: Valid during running, cleared after stopping 2: Valid during running, cleared after receiving the stop command LED thousands: \wedge/\vee keys and digital potentiometer Integral function 0: The Integral function is valid 1: The Integral function is invalid	0x0000
P08.43	Integral ratio of the keypad potentiometer	0.01–10.00s	0.10s
P08.44	UP/DOWN terminals control	0x00–0x221 LED ones: frequency control selection	0x000

Function code	Name	Detailed instruction of parameters	Default value
		0: UP/DOWN terminals setting valid 1: UP/DOWN terminals setting valid LED tens: frequency control selection 0: Only valid when P00.06=0 or P00.07=0 1: All frequency means are valid 2: When the multi-step are priority, it is invalid to the multi-step LED hundreds: action selection when stop 0: Setting valid 1: Valid in the running, clear after stop 2: Valid in the running, clear after receiving the stop commands	
P08.45	UP terminals frequency changing ratio	0.01–50.00Hz/s	0.50 Hz/s
P08.46	DOWN terminals frequency changing ratio	0.01–50.00 Hz/s	0.50 Hz/s
P17.00	Setting frequency	Display current set frequency of the VFD Range: 0.00Hz–P00.03	0.00Hz
P17.02	Ramp reference frequency	Display current ramp given frequency of the VFD. Range: 0.00Hz–P00.03	0.00Hz
P17.14	Digital adjustment	Display the adjustment through the keypad of the VFD. Range: 0.00Hz–P00.03	0.00V

7.9 Analog input

Goodrive300 series VFDs have three analog input terminals and 1 high-speed pulse input terminals (of which, AI1 and AI2 are 0–10V/0–20mA and AI can select voltage input or current input by J3, AI2 can select voltage input or current input by J4 and AI3 is for -10–10V) as the standard configuration. The inputs can be filtered and the maximum and minimum values can be adjusted.

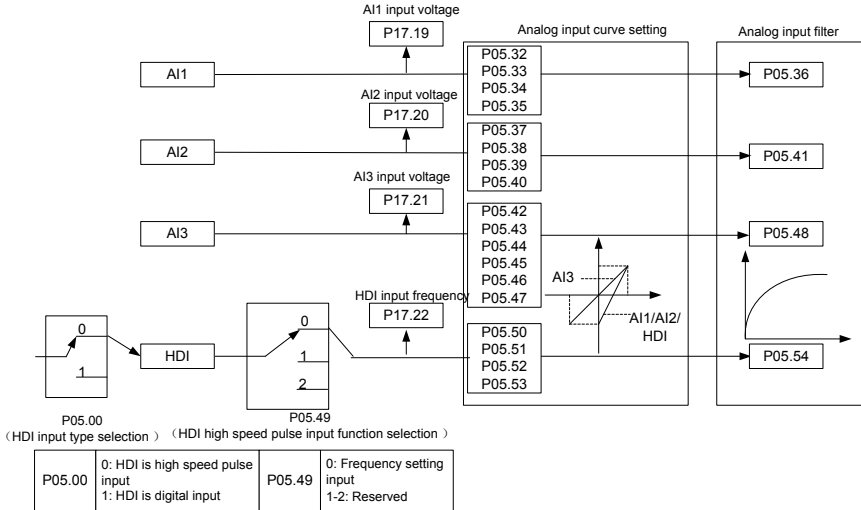

Related parameters

Function code	Name	Detailed instruction of parameters	Default value
P05.00	HDI input selection	0: High pulse input. 1: Digital input.	0
P05.32	Lower limit of AI1	0.00V–P05.34	0.00V
P05.33	Corresponding setting of the lower limit of AI1	-100.0%–100.0%	0.0%
P05.34	Upper limit of AI1	P05.32–10.00V	10.00V
P05.35	Corresponding setting of the upper limit of AI1	-100.0%–100.0%	100.0%
P05.36	AI1 input filter time	0.000s–10.000s	0.100s
P05.37	Lower limit of AI2	0.00V–P05.39	0.00V
P05.38	Corresponding setting of the lower limit of AI2	-100.0%–100.0%	0.0%
P05.39	Upper limit of AI2	P05.37–10.00V	10.00V
P05.40	Corresponding setting of the upper limit of AI2	-100.0%–100.0%	100.0%
P05.41	AI2 input filter time	0.000s–10.000s	0.100s
P05.42	Lower limit of AI3	-10.00V–P05.44	-10.00V
P05.43	Corresponding setting of the lower limit of AI3	-100.0%–100.0%	-100.0%

Function code	Name	Detailed instruction of parameters	Default value
P05.44	Middle value of AI3	P05.42–P05.46	0.00V
P05.45	Corresponding middle setting of AI3	-100.0%–100.0%	0.0%
P05.46	Upper limit of AI3	P05.44–10.00V	10.00V
P05.47	Corresponding setting of the upper limit of AI3	-100.0%–100.0%	100.0%
P05.48	AI3 input filter time	0.000s–10.000s	0.100s
P05.49	HDI high-speed pulse input function selection	0: Frequency setting input, frequency setting source 1: Counter input, high-speed pulse counter input terminals 2: Length counting input, length counter input terminals	0
P05.50	Lower limit frequency of HDI	0.000kHz–P05.52	0.000kHz
P05.51	Corresponding setting of HDI low frequency setting	-100.0%–100.0%	0.0%
P05.52	Upper limit frequency of HDI	P05.50–50.000kHz	50.000 kHz
P05.53	Corresponding setting of upper limit frequency of HDI	-100.0%–100.0%	100.0%
P05.54	HDI frequency input filter time	0.000s–10.000s	0.100s

7.10 Analog output

Goodrive300 series VFDs have 2 analog output terminals (0–10V or 0–20mA) and 1 high speed pulse output terminal. Analog output signal can be filtered and the maximum and minimum values can be adjusted. The analog output signals can be proportional to motor speed, output frequency, output current, motor torque, motor power, etc.

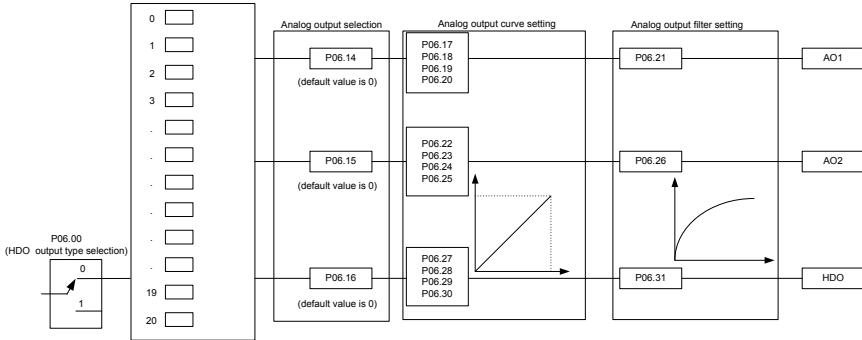

P06.00
 0: open collector high speed pulse output
 1: open collector output

P06.01, P06.02, P06.03, P06.04 output selection					
0	Running frequency	1	Set frequency	2	Ramp reference frequency
3	Running rotation speed	4	Output current (relative to the VFD)	5	Output current (relative to the motor)
6	Output voltage	7	Output power	8	Set torque
9	Output torque	10	Analog AI1 input value	11	Analog AI2 input value
12	Analog AI3 input value	13	HDI input value	14	MODBUS communication setting 1
15	MODBUS communication setting 2	16	PROFIBUS communication setting 1	17	PROFIBUS communication setting 1
18	Torque current (relative to the nominal current of the motor)	19	Exciting current (relative to the nominal current of the motor)	20	Reserved

Output instructions:

Set value	Function	Instructions
0	Running frequency	0—the Max. output frequency
1	Set frequency	0—the Max. output frequency
2	Ramp frequency reference	0—the Max. output frequency
3	Running speed	0–2 times of the rated synchronous rotation speed of the motor
4	Output current (corresponding to the VFD)	0–2 times of the rated current of the VFD
5	Output current (corresponding to the motor)	0–2 times of the rated current of the VFD
6	Output voltage	0–1.5 times of the rated voltage of the VFD
7	Output power	0–2 times of the rated power
8	Setting torque value	0–2 times of the rated current of the motor
9	Output torque	0–2 times of the rated current of the motor
10	AI1	0–10V/0–20mA
11	AI2	0–10V/0–20mA
12	AI3	-10V–10V
13	HDI	0.00–50.00kHz
14	Setting value 1 of Modbus	-1000–1000,1000 corresponds to 100.0%

Set value	Function	Instructions
	communication	
15	Set value 2 of Modbus communication	-1000–1000,1000 corresponds to 100.0%
16	Setting value 1 of PROFIBUS/CANOPEN communication	-1000–1000,1000 corresponds to 100.0%
17	Setting value 2 of PROFIBUS/CANOPEN communication	-1000–1000,100 corresponds to 100.0%
18	Setting value 1 of Ethernet communication	-1000–1000,1000 corresponds to 100.0%
19	Setting value 2 of Ethernet communication	-1000–1000,100 corresponds to 100.0%
20–21	Reserved	
22	Torque current (corresponding to triple the rated current of the motor)	0–3 times of the rated current of the motor
23	Ramp reference frequency (with sign)	0–max. output frequency
24–30	Reserved	

Related parameters

Function code	Name	Detailed instruction of parameters	Default value
P06.00	HDO output	0: Open collector high speed pulse output 1: Open collector output	0
P06.14	AO1 output	0: Running frequency	0
P06.15	AO2 output	1: Set frequency	0
P06.16	HDO high-speed pulse output	2: Ramp reference frequency 3: Running rotation speed (relative to 2 times the synchronous rotation speed of the motor) 4: Output current (relative to 2 times the rated current of the VFD) 5: Output current (relative to 2 times the rated current of the motor) 6: Output voltage (relative to 1.5 times the rated voltage of the VFD)	0

Function code	Name	Detailed instruction of parameters	Default value
		7: Output power (relative to 2 times the rated power of the motor) 8: Set torque value (relative to 2 times the rated torque of the motor) 9: Output torque (relative to 2 times the rated torque of the motor) 10: Analog AI1 input value 11: Analog AI2 input value 12: Analog AI3 input value 13: Input value of high-speed pulse HDI 14: Modbus communication set value 1 15: Modbus communication set value 2 16: Set value 1 of PROFIBUS/CANopen communication 17: Set value 2 of PROFIBUS/CANopen communication 18: Set value 1 of Ethernet communication 19: Set value 2 of Ethernet communication 20–21: Reserved 22: Torque current (corresponding to triple the rated current of the motor) 23: Ramp reference frequency (with sign) 24–30: Reserved	
P06.17	Lower output limit of AO1	-100.0%–P06.19	0.0%
P06.18	Corresponding AO1 output of lower limit	0.00V–10.00V	0.00V
P06.19	Upper output limit of AO1	P06.17–100.0%	100.0%
P06.20	The corresponding AO1 output of upper limit	0.00V–10.00V	10.00V
P06.21	AO1 output filter time	0.000s–10.000s	0.000s
P06.22	Lower output limit of AO2	-100.0%–P06.24	0.0%
P06.23	Corresponding AO2 output of lower limit	0.00V–10.00V	0.00V
P06.24	Upper output limit of AO2	P06.22–100.0%	100.0%

Function code	Name	Detailed instruction of parameters	Default value
P06.25	The corresponding AO2 output of upper limit	0.00V–10.00V	10.00V
P06.26	AO2 output filter time	0.000s–10.000s	0.000s
P06.27	Lower output limit of HDO	-100.0%–P06.29	0.00%
P06.28	Corresponding HDO output of lower limit	0.00–50.00kHz	0.0kHz
P06.29	Upper output limit of HDO	P06.27–100.0%	100.0%
P06.30	Corresponding HDO output of upper limit	0.00–50.00kHz	50.00kHz
P06.31	HDO output filter time	0.000s–10.000s	0.000s

7.11 Digital input

Goodrive300 series VFDs have 8 programmable digital input terminals and 1 open circuit electrode output terminal in the standard configuration. All functions of the digital input terminals are programmable by the function codes. Open collector input can be selected into high speed pulse input terminal or common switch input terminal by function code. When selected into HDI, the user can select HDI high speed pulse input as frequency given, counting input or length pulse input by setting.

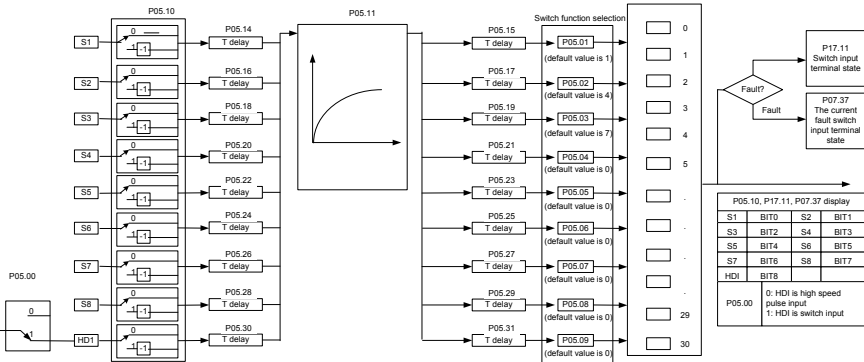

0	No function	1	Forward running	2	Reverse running	3	3-wire running control
4	Forward jogging	5	Reverse jogging	6	Coast to stop	7	Fault reset
8	Running pause	9	External fault input	10	Frequency setting increasing (UP)	11	Frequency setting decreasing (DOWN)
12	Frequency increase/decrease setting clear	13	Shifting between A frequency and B frequency	14	Shifting between combination setting and A frequency	15	Shifting between combination setting and B frequency
16	Multi-stage speed terminal 1	17	Multi-stage speed terminal 2	18	Multi-stage speed terminal 3	19	Multi-stage speed terminal 4
20	Multi-stage speed pause	21	ACC/DEC time selection 1	22	ACC/DEC time selection 2	23	Simple PLC stopping reset
23	Simple PLC pause	25	PID control pause	26	Frequency setting (stop at the current frequency)	27	Traverse pause (stop at the middle frequency)
28	Counter reset	29	Torque control disabling	30	ACC/DEC disabling	31	Counter triggering
32	Length reset	33	Frequency increase/decrease setting clear	34	DC braking	35	Shift from motor 1 to motor 2
36	Shift the command to the keypad	37	Shift the command to the terminal	38	Shift the command to the communication	39	Pre-exciting command
40	Power consumption clear	41	Power consumption keeping	42-63	Reserved		

This parameter is used to set the function corresponds to the digital multi-function terminals.

Note: two different multi-function terminals cannot be set as one function.

Set value	Function	Instructions
0	No function	The VFD does not work even there is input signal. It is necessary to set the terminal which cannot be used to non-function to avoid misacting.
1	Forward running(FWD)	The forward or reverse rotation of the VFD can be controlled by the external terminals.
2	Reverse running(REV)	
3	3-wire running control	The terminal can determine the running mode of the VFD is 3-wire control mode. Refer to P05.13 for detailed instruction of 3-wire control mode.
4	Forward jogging	See P08.06, P08.07 and P08.08 for jogging frequency, jogging ACC/DEC time.
5	Reverse jogging	
6	Coast to stop	The VFD closes off the output. The motor is not controlled by the VFD during the stopping. This method is usually to be used when the load inertia is big and it has no requirement to the stopping time. It has the same meaning with the "coast to stop" in P01.08 and usually used in remote control.
7	Fault reset	External fault reset. It has the same function with the reset function of STOP/RST on the keypad. This function can realize remote fault reset.
8	Operation pause	The VFD decelerates to stop. But all running parameters are in the memory state. For example, PLC parameters, traverse parameters and PID parameters. After the signal disappears, the VFD will come back to the state before stopping.
9	External fault input	When the external fault signal is sent to the VFD, the VFD will report the fault and stop.
10	Frequency setting up(UP)	This parameter is used to modify the increasing and decreasing command during the external terminal given frequency.
12	Frequency setting down(DOWN)	
12	Frequency increasing/decreasing setting clear	<pre> graph LR K1 --- UP[UP terminal] K2 --- DOWN[DOWN terminal] K3 --- COM[UP/DOWN terminals] COM --- COM2[COM] </pre>

Set value	Function	Instructions																				
		Frequency increasing/decreasing setting clear terminal can cancel the assistant channel frequency set by the internal UP/DOWN of the VFD to make the given frequency restore to the frequency given by the main given frequency channel.																				
13	Switch between A setting and B setting	This function can realize the shifting between the frequency setting channels. The 13 th function can realize the shifting between A frequency given channel and B frequency given channel. The 14 th function can realize the shifting between A frequency given channel and the combination setting channel set by P00.09 The 15 th function can realize the shifting between B frequency given channel and the combination setting channel set by P00.09																				
14	Switch between A setting and combination setting																					
15	Switch between B setting and combination setting																					
16	Multi-step speed terminal 1	The 16 stage speeds can be set by the combination of digital state of four terminals. Note: multi-step speed 1 is the low bit, multi-step speed 4 is the high bit.																				
17	Multi-step speed terminal 2																					
18	Multi-step speed terminal 3																					
19	Multi-step speed terminal 4		Multi-step speed 4	Multi-step speed 3	Multi-step speed 2	Multi-step speed 1	BIT3	BIT2	BIT1	BIT0												
Multi-step speed 4	Multi-step speed 3	Multi-step speed 2	Multi-step speed 1																			
BIT3	BIT2	BIT1	BIT0																			
20	Multi-step speed pause	Shield the multi-step speed selection terminal function to keep the setting value at the current state.																				
21	ACC/DEC time selection 1	Select 4 ACC/DEC time by the combination of the 2 terminals.																				
22	ACC/DEC time selection 2	<table border="1"> <thead> <tr> <th>Terminal 1</th> <th>Terminal 2</th> <th>ACC/DEC time selection</th> <th>Corresponding parameter</th> </tr> </thead> <tbody> <tr> <td>OFF</td> <td>OFF</td> <td>ACC/DEC time 1</td> <td>P00.11/P00.12</td> </tr> <tr> <td>ON</td> <td>OFF</td> <td>ACC/DEC time 2</td> <td>P08.00/P08.01</td> </tr> <tr> <td>OFF</td> <td>ON</td> <td>ACC/DEC time 3</td> <td>P08.02/P08.03</td> </tr> <tr> <td>ON</td> <td>ON</td> <td>ACC/DEC time 4</td> <td>P08.04/P08.05</td> </tr> </tbody> </table>	Terminal 1	Terminal 2	ACC/DEC time selection	Corresponding parameter	OFF	OFF	ACC/DEC time 1	P00.11/P00.12	ON	OFF	ACC/DEC time 2	P08.00/P08.01	OFF	ON	ACC/DEC time 3	P08.02/P08.03	ON	ON	ACC/DEC time 4	P08.04/P08.05
Terminal 1	Terminal 2	ACC/DEC time selection	Corresponding parameter																			
OFF	OFF	ACC/DEC time 1	P00.11/P00.12																			
ON	OFF	ACC/DEC time 2	P08.00/P08.01																			
OFF	ON	ACC/DEC time 3	P08.02/P08.03																			
ON	ON	ACC/DEC time 4	P08.04/P08.05																			
23	Simple PLC stop reset	Restart simple PLC and clear the memory state of PLC.																				
24	Simple PLC pause	Program pause during PLC implement. Run at the current speed stage. After cancel the function, simple																				

Set value	Function	Instructions
		PLC continues to run.
25	PID control pause	Temporal PID invalid and the VFD will output at the current frequency.
26	Traverse pause (stop at the current frequency)	The VFD will stop at the current output and after canceling the function, the VFD will continue to traverse run at the current frequency.
27	Traverse reset (return to the middle frequency)	The setting frequency of the VFD will come back to the middle frequency.
28	Counter reset	Counter clear
29	Torque control disabling	The VFD shifts from torque control mode to speed control mode.
30	ACC/DEC disabling	Ensure the VFD will not be affected by the external signals (except for the stopping command) and keep the current output frequency.
31	Counter triggering	Enable the pulse counter.
32	Length reset	Length counter clear
33	Frequency increasing/decreasing setting temporal clear	When the terminal closes, the frequency set by UP/DOWN can be cleared. All set frequency will be restored into the given frequency by the frequency command channel and the frequency will come back to the value after the frequency increasing or decreasing.
34	DC braking	The VFD will begin DC braking after the valid command.
35	Switch between motor1 and motor2	Motor-shifting can be controlled after the terminal is valid.
36	Switch commands to keypad	After the function terminal become valid, the running command channel will be shifted into keypad running command channel and the running command channel will come back to the original state if the function terminal is invalid.
37	Switch commands to terminals	After the function terminal become valid, the running command channel will be shifted into terminal running command channel and the running command channel will come back to the original state if the function terminal is invalid.
38	Switch commands to	After the function terminal become valid, the running

Set value	Function	Instructions
	communication	command channel will be shifted into communication running command channel and the running command channel will come back to the original state if the function terminal is invalid.
39	Pre-excitation commands	Perform pre-exciting if the terminal is valid until the terminal is invalid.
40	Power consumption clear	The power consumption will be cleared after the command is valid.
41	Power consumption retention	If the command is valid, the current running of the VFD will not affect its power consumption.
42–60	Reversed	
61	PID pole switching	Switch the output pole of PID and be used with P09.03
62–63	Reversed	

Related parameters

Function code	Name	Detailed instruction of parameters	Default value
P05.00	HDI input selection	0: High pulse input 1: Digital input	0
P05.01	S1 terminals function selection	0: No function	1
P05.02	S2 terminals function selection	1: Forward rotation operation 2: Reverse rotation operation 3: 3-wire control operation	4
P05.03	S3 terminals function selection	4: Forward jogging 5: Reverse jogging	7
P05.04	S4 terminals function selection	6: Coast to stop 7: Fault reset	0
P05.05	S5 terminals function selection	8: Operation pause 9: External fault input	0
P05.06	S6 terminals function selection	10: Increasing frequency setting (UP) 11: Decreasing frequency setting	0
P05.07	S7 terminals function selection	(DOWN) 12: Frequency setting clear	0
P05.08	S8 terminals function selection	13: Shift between A setting and B setting 14: Shift between combination setting and A setting	0
P05.09	HDI terminal function selection	15: Shift between combination setting	0

Function code	Name	Detailed instruction of parameters	Default value
		and B setting 16: Multi-step speed terminal 1 17: Multi-step speed terminal 2 18: Multi-step speed terminal 3 19: Multi- step speed terminal 4 20: Multi- step speed pause 21: ACC/DEC time 1 22: ACC/DEC time 2 23: Simple PLC stop reset 24: Simple PLC pause 25: PID control pause 26: Traverse Pause (stop at the current frequency) 27: Traverse reset (return to the center frequency) 28: Counter reset 29: Torque control disabling 30: ACC/DEC disabling 31: Counter triggering 32: Length reset 33: Cancel the frequency change setting temporarily 34: DC brake 35: Shift the motor 1 into motor 2 36: Shift the command to the keypad 37: Shift the command to the terminals 38: Shift the command to the communication 39: Pre-magnetized command 40: Consumption power clear 41: Consumption power holding 42–63: Reserved 61: PID pole switching 62–63: Reserved	
P05.10	Polarity selection of the input terminals	0x000–0x1FF	0x000
P05.11	ON-OFF filter time	0.000–1.000s	0.010s
P05.12	Virtual terminals setting	0x000–0x1FF (0: Disabled, 1: Enabled)	0

Function code	Name	Detailed instruction of parameters	Default value
		BIT0: S1 virtual terminal BIT1: S2 virtual terminal BIT2: S3 virtual terminal BIT3: S4 virtual terminal BIT4: S5 virtual terminal BIT5: S6 virtual terminal BIT6: S7 virtual terminal BIT7: S8 virtual terminal BIT8: HDI virtual terminal	
P05.13	Terminals control running mode	0: 2-wire control 1 1: 2-wire control 2 2: 3-wire control 1 3: 3-wire control 2	0
P05.14	Switch-on delay of S1 terminal	0.000–50.000s	0.000s
P05.15	Switch-off delay of S1 terminal	0.000–50.000s	0.000s
P05.16	Switch-on delay of S2 terminal	0.000–50.000s	0.000s
P05.17	Switch-off delay of S2 terminal	0.000–50.000s	0.000s
P05.18	Switch-on delay of S3 terminal	0.000–50.000s	0.000s
P05.19	Switch-off delay of S3 terminal	0.000–50.000s	0.000s
P05.20	Switch-on delay of S4 terminal	0.000–50.000s	0.000s
P05.21	Switch-off delay of S4 terminal	0.000–50.000s	0.000s
P05.22	Switch-on delay of S5 terminal	0.000–50.000s	0.000s
P05.23	Switch-off delay of S5 terminal	0.000–50.000s	0.000s
P05.24	Switch-on delay of S6 terminal	0.000–50.000s	0.000s
P05.25	Switch-off delay of S6 terminal	0.000–50.000s	0.000s

Function code	Name	Detailed instruction of parameters	Default value
P05.26	Switch-on delay of S7 terminal	0.000–50.000s	0.000s
P05.27	Switch-off delay of S7 terminal	0.000–50.000s	0.000s
P05.28	Switch-on delay of S8 terminal	0.000–50.000s	0.000s
P05.29	Switch-off delay of S8 terminal	0.000–50.000s	0.000s
P05.30	Switch-on delay of HDI terminal	0.000–50.000s	0.000s
P05.31	Switch-off delay of HDI terminal	0.000–50.000s	0.000s
P07.39	Bus voltage at current fault		0
P17.12	Digital input terminals state		0

7.12 Digital output

Goodrive300 series VFDs have 2 relay output terminals, 1 open collector output terminal Y, and 1 high-speed pulse output terminal (HDO) in the standard configuration. All functions of the digital output terminals are programmable by using function codes, where the HDO can be set to high-speed pulse output or switch output through function codes.

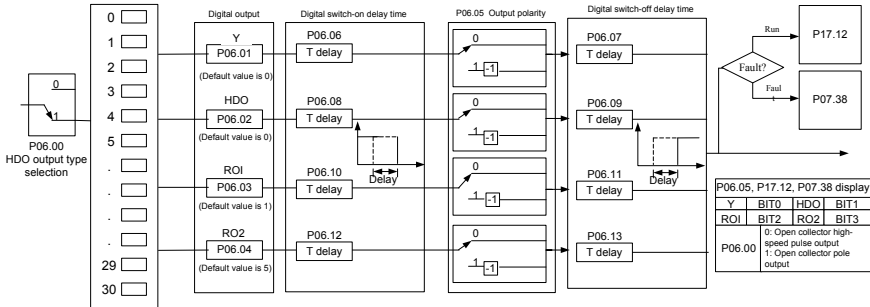

0	Invalid	1	Running	2	Forward running
3	Reverse running	4	Jogging	5	VFD fault
6	FDT1	7	FDT2	8	Frequency arrival
9	Zero-speed running	10	Upper-limit frequency arrival	11	Lower-limit frequency arrival
12	Ready	13	Pre-exciting	14	Overload pre-alarm
15	Underload pre-alarm	16	Simple PLC stage completion	17	Simple PLC cycle completion
18	Set counting arrival	19	Fixed counting arrival	20	External fault valid
21	Length arrival	22	Running time arrival	23	Modbus communication virtual terminal output
24	PROFIBUS communication virtual terminal output	25-30	Reserved		

The following table is the option of the four function parameters and selecting the repeated output terminal function is allowed.

Set value	Function	Instructions
0	Invalid	The output terminal has no function.
1	Running	Output ON signal when the VFD is running and there is frequency output.
2	Forward running	Output ON signal when the VFD is running forward and there is frequency output.
3	Reverse running	Output ON signal when the VFD is running reverse and there is frequency output.
4	Jogging	Output ON signal when the VFD is jogging and there is frequency output.
5	VFD fault	Output ON signal when the VFD is in fault
6	FDT1	Please refer to P08.32 and P08.33 for detailed information.
7	FDT2	Please refer to P08.34 and P08.35 for detailed information.
8	Frequency arrival	Please refer to P08.36 for detailed information.
9	Zero-speed running	Output ON signal when the output frequency and given frequency of the VFD is 0 at the same time.
10	Upper-limit frequency arrival	Output ON signal when the running frequency of the

Set value	Function	Instructions
		VFD is the upper limit frequency.
11	Lower-limit frequency arrival	Output ON signal when the running frequency of the VFD is the lower limit frequency.
12	Ready	When the main circuit and the control circuit is established and the protection function of the VFD is not active. The VFD is in the running state and it will output ON signal.
13	Pre-exciting	Output ON signal when the VFD is in the pre-exciting state.
14	Overload pre-alarm	Output ON signal if the VFD is beyond the pre-alarm point. Refer to P11.08–P11.10 for the detailed instruction.
15	Underload pre-alarm	Output ON signal if the VFD is beyond the pre-alarm point. Refer to P11.11–P11.12 for the detailed instruction.
16	Simple PLC stage completion	Output signal if the simple PLC stage is completed.
17	Simple PLC cycle completion	Output signal if the simple PLC cycle is completed.
18	Set counting arrival	Output ON signal if the detected counting exceeds the set value of P08.25.
19	Fixed counting arrival	Output ON signal if the detected counting exceeds the set value of P08.26.
20	External fault valid	Output ON signal if external fault occurs.
21	Length arrival	Output ON signal if the actual detected length exceeds the set length by P08.19.
22	Running time arrival	Output ON signal if the accumulative running time of the VFD exceeds the setting time by P08.27.
23	Modbus communication virtual terminal output	Output corresponding signal according to the setting value of Modbus. Output ON signal if the setting value is 1 and output OFF signal if the setting value is 0.
24	PROFIBUS communication virtual terminal output	Output a corresponding signal according to the set value of PROFIBUS/CANOPEN. Output the signal of ON if the set value is 1 and output the signal of OFF if the set value is 0.
25	Ethernet communication Virtual terminal output	Output a corresponding signal according to the set value of Ethernet. Output the signal of ON if the set

Set value	Function	Instructions
		value is 1 and output the signal of OFF if the set value is 0.
26	DC bus voltage establishment finished	The output is valid when the bus voltage reaches the undervoltage point of the inverter.
27-30	Reserved	

Related parameters

Function code	Name	Detailed instruction of parameters	Default value
P06.00	HDO output	0: Open collector high-speed pulse output 1: Open collector output	0
P06.01	Y output	0: Invalid	0
P06.02	HDO output	1: In operation	0
P06.03	Relay RO1 output	2: Forward rotation operation 3: Reverse rotation operation	1
P06.04	Relay RO2 output	4: Jogging operation 5: The VFD fault 6: Frequency degree test FDT1 7: Frequency degree test FDT2 8: Frequency arrival 9: Zero speed running 10: Upper limit frequency arrival 11: Lower limit frequency arrival 12: Ready for operation 13: Pre-magnetizing 14: Overload pre-alarm 15: Underload pre-alarm 16: Completion of simple PLC stage 17: Completion of simple PLC cycle 18: Set count value reached 19: Specified count value reached 20: External fault valid 21: Length arrival 22: Running time arrival 23: Modbus communication virtual terminals output 24: PROFIBUS/CANopen communication virtual terminals output	5

Function code	Name	Detailed instruction of parameters	Default value
		25: Ethernet communication virtual terminals output 26: Voltage establishment finished 27–30: Reserved	
P06.05	Polarity of output terminals	0x00–0x0F	0x00
P06.06	Y switch-on delay time	0.000–50.000s	0.000s
P06.07	Y switch-off delay time	0.000–50.000s	0.000s
P06.08	HDO switch-on delay time	0.000–50.000s (valid only when P06.00=1)	0.000s
P06.09	HDO switch-off delay time	0.000–50.000s (valid only when P06.00=1)	0.000s
P06.10	RO1 switch-on delay time	0.000–50.000s	0.000s
P06.11	RO1 switch-off delay time	0.000–50.000s	0.000s
P06.12	RO2 switch-on delay time	0.000–50.000s	0.000s
P06.13	RO2 switch-off delay time	0.000–50.000s	0.000s
P07.40	Output terminals state at current fault		0
P17.13	Digital output terminals state		0

7.13 Simple PLC

Simple PLC function is also a multi-step speed generator. The VFD can change the running frequency, direction to meet the need of processing according to the running time automatically. In the past, this function needs to be assisted by external PLC, but now the VFD can realize this function by itself.

The series VFDs can control 16-stage speed with 4 groups of ACC/DEC time.

The multi-function digital output terminals or multi-function relay output an ON signal when the set PLC finishes a circle (or a stage).

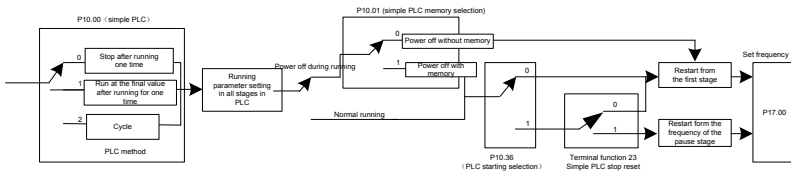

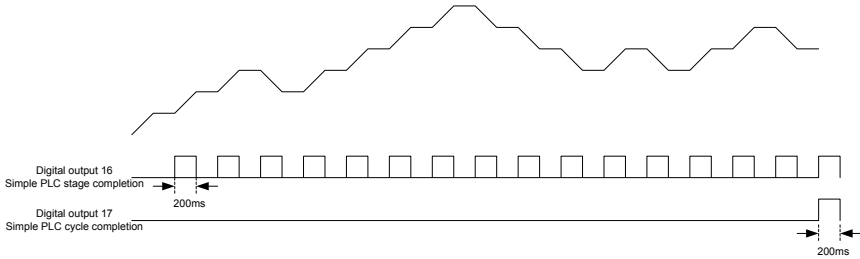

Related parameters

Function code	Name	Detailed instruction of parameters	Default value
P10.00	Simple PLC	0: Stop after running once 1: Run at the final value after running once 2: Cycle running	0
P10.01	Simple PLC memory	0: Power loss without memory 1: Power loss with memory	0
P10.02	Multi-step speed 0	-100.0~100.0%	0.0%
P10.03	Running time of step 0	0.0~6553.5s (min)	0.0s
P10.04	Multi-step speed 1	-100.0~100.0%	0.0%
P10.05	Running time of step 1	0.0~6553.5s (min)	0.0s
P10.06	Multi-step speed 2	-100.0~100.0%	0.0%
P10.07	Running time of step 2	0.0~6553.5s (min)	0.0s
P10.08	Multi-step speed 3	-100.0~100.0%	0.0%
P10.09	Running time of step 3	0.0~6553.5s (min)	0.0s
P10.10	Multi-step speed 4	-100.0~100.0%	0.0%
P10.11	Running time of step 4	0.0~6553.5s (min)	0.0s
P10.12	Multi-step speed 5	-100.0~100.0%	0.0%
P10.13	Running time of step 5	0.0~6553.5s (min)	0.0s
P10.14	Multi-step speed 6	-100.0~100.0%	0.0%
P10.15	Running time of step 6	0.0~6553.5s (min)	0.0s
P10.16	Multi-step speed 7	-100.0~100.0%	0.0%
P10.17	Running time of step 7	0.0~6553.5s (min)	0.0s
P10.18	Multi-step speed 8	-100.0~100.0%	0.0%
P10.19	Running time of step 8	0.0~6553.5s (min)	0.0s
P10.20	Multi-step speed 9	-100.0~100.0%	0.0%
P10.21	Running time of step 9	0.0~6553.5s (min)	0.0s
P10.22	Multi-step speed 10	-100.0~100.0%	0.0%

Function code	Name	Detailed instruction of parameters	Default value
P10.23	Running time of step 10	0.0–6553.5s (min)	0.0s
P10.24	Multi-step speed 11	-100.0–100.0%	0.0%
P10.25	Running time of step 11	0.0–6553.5s (min)	0.0s
P10.26	Multi-step speed 12	-100.0–100.0%	0.0%
P10.27	Running time of step 12	0.0–6553.5s (min)	0.0s
P10.28	Multi-step speed 13	-100.0–100.0%	0.0%
P10.29	Running time of step 13	0.0–6553.5s (min)	0.0s
P10.30	Multi-step speed 14	-100.0–100.0%	0.0%
P10.31	Running time of step 14	0.0–6553.5s (min)	0.0s
P10.32	Multi-step speed 15	-100.0–100.0%	0.0%
P10.33	Running time of step 15	0.0–6553.5s (min)	0.0s
P10.36	PLC restart	0: Restart from the first stage 1:Continue to run from the stop frequency	0
P10.34	Simple PLC 0–7 step ACC/DEC time	0x0000–0XFFFF	0000
P10.35	Simple PLC 8–15 step ACC/DEC time	0x0000–0XFFFF	0000
P05.01–P05.09	Digital input function selection	23:Simple PLC stop reset 24:Simple PLC pause	
P06.01–P06.04	Digital output function selection	15: Underload pre-alarm 16:Completion of simple PLC stage	
P17.00	Setting frequency	0.00Hz–P00.03 (Max. output frequency)	0.00Hz
P17.27	Simple PLC and the current stage of the multi-step speed	0–15	

7.14 Multi-step speed running

Set the parameters when the VFD carries out multi-step speed running. Goodrive300 series VFDs can set 16 stage speed which can be selected by the combination code of multi-step speed terminals 1–4. They correspond to multi-step speed 0 to 15.

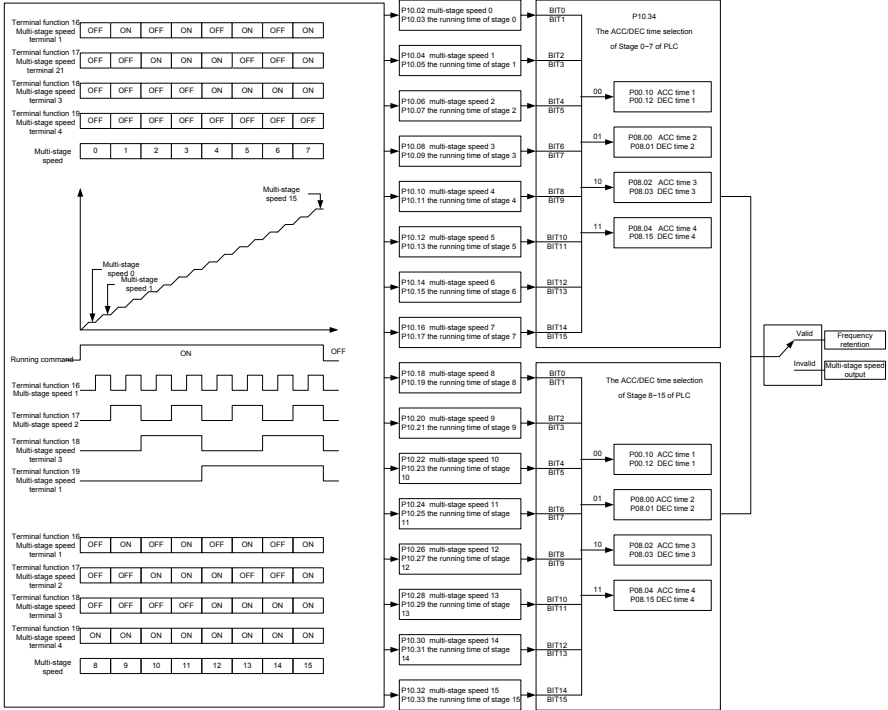

Related parameters

Function code	Name	Detailed instruction of parameters	Default value
P10.02	Multi-step speed 0	-100.0-100.0%	0.0%
P10.03	Running time of step 0	0.0-6553.5s (min)	0.0s
P10.04	Multi-step speed 1	-100.0-100.0%	0.0%
P10.05	Running time of step 1	0.0-6553.5s (min)	0.0s
P10.06	Multi-step speed 2	-100.0-100.0%	0.0%
P10.07	Running time of step 2	0.0-6553.5s (min)	0.0s
P10.08	Multi-step speed 3	-100.0-100.0%	0.0%
P10.09	Running time of step 3	0.0-6553.5s (min)	0.0s
P10.10	Multi-step speed 4	-100.0-100.0%	0.0%
P10.11	Running time of step 4	0.0-6553.5s (min)	0.0s
P10.12	Multi-step speed 5	-100.0-100.0%	0.0%
P10.13	Running time of step 5	0.0-6553.5s (min)	0.0s
P10.14	Multi-step speed 6	-100.0-100.0%	0.0%

Function code	Name	Detailed instruction of parameters	Default value
P10.15	Running time of step 6	0.0–6553.5s (min)	0.0s
P10.16	Multi-step speed 7	-100.0–100.0%	0.0%
P10.17	Running time of step 7	0.0–6553.5s (min)	0.0s
P10.18	Multi-step speed 8	-100.0–100.0%	0.0%
P10.19	Running time of step 8	0.0–6553.5s (min)	0.0s
P10.20	Multi-step speed 9	-100.0–100.0%	0.0%
P10.21	Running time of step 9	0.0–6553.5s (min)	0.0s
P10.22	Multi-step speed 10	-100.0–100.0%	0.0%
P10.23	Running time of step 10	0.0–6553.5s (min)	0.0s
P10.24	Multi-step speed 11	-100.0–100.0%	0.0%
P10.25	Running time of step 11	0.0–6553.5s (min)	0.0s
P10.26	Multi-step speed 12	-100.0–100.0%	0.0%
P10.27	Running time of step 12	0.0–6553.5s (min)	0.0s
P10.28	Multi-step speed 13	-100.0–100.0%	0.0%
P10.29	Running time of step 13	0.0–6553.5s (min)	0.0s
P10.30	Multi-step speed 14	-100.0–100.0%	0.0%
P10.31	Running time of step 14	0.0–6553.5s (min)	0.0s
P10.32	Multi-step speed 15	-100.0–100.0%	0.0%
P10.33	Running time of step 15	0.0–6553.5s (min)	0.0s
P10.34	Simple PLC 0–7 step ACC/DEC time	0x0000–0xFFFF	0000
P10.35	Simple PLC 8–15 step ACC/DEC time	0x0000–0xFFFF	0000
P05.01– P05.09	Digital input function selection	16: Multi-step speed terminal 1 17: Multi-step speed terminal 2 18: Multi-step speed terminal 3 19: Multi-step speed terminal 4 20: Multi-step speed pause	
P17.27	Simple PLC and the current step of the multi-step speed	0–15	0

7.15 PID control

PID control is commonly used to control the procedure through the controlled procedure. Adjust the output frequency by proportional, integral, differential operation with the dispersion of the target signals to stabilize the value on the target. It is possible to apply to the flow, pressure and temperature control. Figure of basic control is as below:

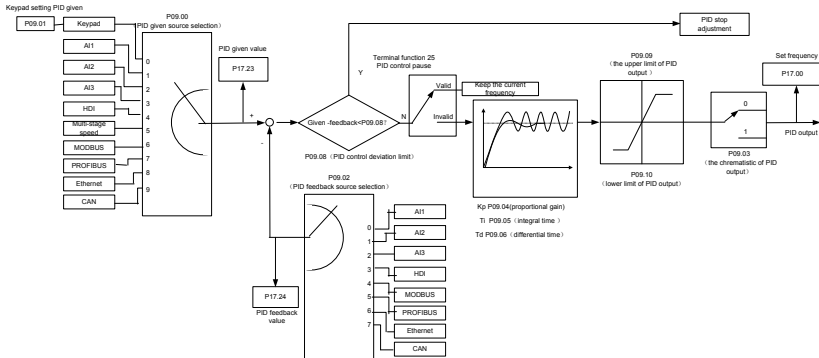

Simple illustration of the PID control operation and adjustment:

Proportional adjustment (Kp): when there is an error between the feedback and the reference, a proportional adjustment will be output. If the error is constant, the adjustment will be constant, too. Proportional adjustment can respond to the feedback change quickly, but it cannot realize non-fault control. The gain will increase with the adjustment speed, but too much gain may cause vibration. The adjustment method is: set a long integral time and derivative time to 0 first. Secondly make the system run by proportional adjustment and change the reference. And then watch the error of the feedback signal and the reference. If the static error is available (for example, increasing the reference, the feedback will be less than the reference after a stable system), continue to increase the gain, vice versa. Repeat the action until the static error achieves a little value.

Integral time (Ti): the output adjustment will accumulate if there is an error between the feedback and the reference. The adjustment will keep on increasing until the error disappears. If the error is existent all the time, the integration adjustor can cancel the static error effectively. Vibration may occur as a result of unstable system caused by repeated over-adjustment if the integration adjustor is too strong. The features of this kind of vibration are: the fluctuating feedback signal (around the reference) and increasing traverse range will cause vibration. Adjust the integral time parameter from a big value to a little one to change the integral time and monitor the result until a stable system speed is available.

Derivative time (Td): when the error between the feedback and the reference, a proportional adjustment will be output. The adjustment only depends on the direction and value of the error change other than the error itself. The derivation adjustment controls the change of feedback signals according to the changing trend when it fluctuates. Because the derivation may enlarge the interference to the system, especially the frequent-changing interference, please use it carefully.

When P00.06, P00.07=7 or P04.27=6, the running mode of the VFD is procedure PID control.

7.15.1 General steps of PID parameters setting:

a Ensure the gain P

When ensure the gain P, firstly cancel the PID integration and derivation (set Ti=0 and Td=0, see the

PID parameter setting for detailed information) to make proportional adjustment is the only method to PID. Set the input as 60%–70% of the permitted Max. Value and increase gain P from 0 until the system vibration occurs, vice versa, and record the PID value and set it to 60%–70% of the current value. Then the gain P commission is finished.

b Ensure the integral time T_i

After ensuring the gain P, set an original value of a bigger integral time and decrease it until the system vibration occurs, vice versa, until the system vibration disappear. Record the T_i and set the integral time to 150%–180% of the current value. Then integral time commission is finished.

c Ensure the derivative time T_d

Generally, it is not necessary to set T_d which is 0.

If it needs to be set, set it to 30% of the value without vibration via the same method with P and T_i .

d Commission the system with and without load and then adjust the PID parameter until it is available.

7.15.2 PID inching

After setting the PID control parameters, inching is possible by following means:

Control the overshoot

Shorten the derivative time and prolong the integral time when overshoot occurs.

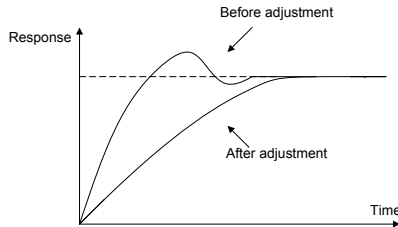

Achieve the stable state as soon as possible

Shorten the integral time (T_i) and prolong the derivative time (T_d) even the overshoot occurs, but the control should be stable as soon as possible.

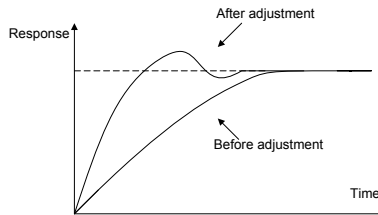

Control long vibration

If the vibration periods are longer than the set value of integral time (T_i), it is necessary to prolong the

integral time (Ti) to control the vibration for the strong integration.

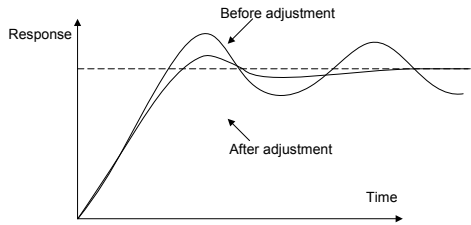

Control short vibration

Short vibration period and the same set value with the derivative time (Td) mean that the derivative time is strong. Shortening the derivative time (Td) can control the vibration. When setting the derivative time as 0.00 (no derivative control) is useless to control the vibration, decrease the gain.

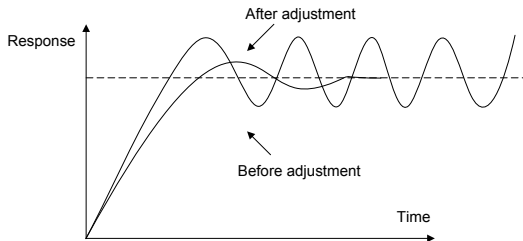

Related parameters

Function code	Name	Detailed instruction of parameters	Default value
P09.00	PID reference source	0: Keypad (P09.01) 1: AI1 2: AI2 3: AI3 4: HDI 5: Multi-step speed set 6: Modbus communication set 7: PROFIBUS/CANopen communication set 8: Ethernet communication set 9: Reserved	0
P09.01	Keypad PID preset	-100.0%~100.0%	0.0%
P09.02	PID feedback source	0: AI1 1: AI2	0

Function code	Name	Detailed instruction of parameters	Default value
		2: AI3 3: HDI 4: Modbus communication feedback 5: PROFIBUS/CANopen communication feedback 6: Ethernet communication feedback 7: Reserve	
P09.03	PID output feature	0: PID output is positive 1: PID output is negative	0
P09.04	Proportional gain (Kp)	0.00–100.00	1.00
P09.05	Integral time (Ti)	0.00–10.00s	0.10s
P09.06	Differential time (Td)	0.00–10.00s	0.00s
P09.07	Sampling cycle (T)	0.000–10.000s	0.100s
P09.08	PID control deviation limit	0.0–100.0%	0.0%
P09.09	Output upper limit of PID	P09.10–100.0% (Max. frequency or the Max. voltage)	100.0%
P09.10	Output lower limit of PID	-100.0%–P09.09 (Max. frequency or the Max. voltage)	0.0%
P09.11	Detection value of feedback offline	0.0–100.0%	0.0%
P09.12	Detection time of feedback offline	0.0–3600.0s	1.0s
P09.13	PID adjustment	0x0000–0x1111 LED ones: 0: Keep on integral adjustment when the frequency achieves the upper and low limit; the integration shows the change between the reference and the feedback unless it reaches the internal integral limit. When the trend between the reference and the feedback changes, it needs more time to offset the impact of continuous working and the integration will change with the trend. 1: Stop integral adjustment when the frequency achieves the upper and low limit. If the integration keeps stable, and	0x0001

Function code	Name	Detailed instruction of parameters	Default value
		the trend between the reference and the feedback changes, the integration will change with the trend quickly. LED tens: P00.08 is 0 0: The same with the setting direction; if the output of PID adjustment is different from the current running direction, the internal will output 0 forcibly. 1: Opposite to the setting direction LED hundreds: P00.08 is 0 0: Limit to the maximum frequency 1: Limit to frequency A LED thousands: 0: A+B frequency, the buffer of A frequency is invalid 1: A+B frequency, the buffer of A frequency is valid ACC/DEC is determined by ACC time 4 of P08.04	
P17.00	Setting frequency	0.00Hz–P00.03 (Max. frequency)	0.00Hz
P17.23	PID reference	-100.0–100.0%	0.0%
P17.24	PID feedback	-100.0–100.0%	0.0%

7.16 Traverse running

Traverse is applied in some industries such as textile, chemical fiber and cases where traverse and convolution is required. The working flowchart is as below:

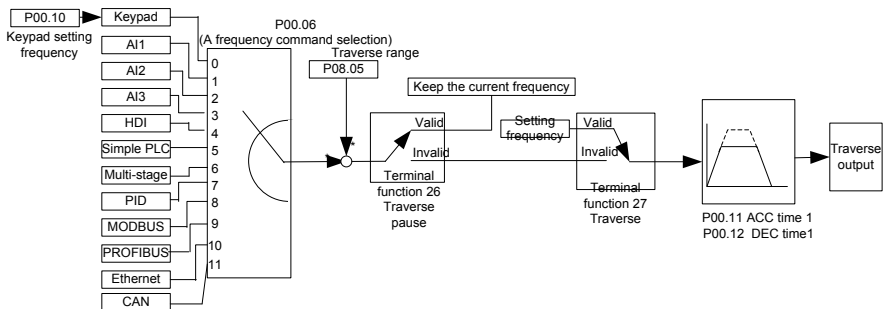

Function code	Name	Detailed instruction of parameters	Default value
P00.03	Max. output frequency	P00.03–400.00Hz	50.00Hz
P00.06	A frequency command	0: Keypad 1: AI1 2: AI2 3: AI3 4: High-speed pulse HDI 5: Simple PLC program 6: Multi-step speed running 7: PID control setting 8: Modbus communication setting 9: PROFIBUS/CANopen communication setting 10: Ethernet communication setting(reserved) 11: Reserved	0
P00.11	ACC time 1	0.0–3600.0s	Depend on model
P00.12	DEC time 1	0.0–3600.0s	Depend on model
P05.01–P05.09	Digital input function selection	26: Traverse Pause (stop at the current frequency) 27: Traverse reset (return to the center frequency)	
P08.15	Traverse range	0.0–100.0% (corresponding to the set frequency)	0.0%
P08.16	Sudden jumping frequency range	0.0–50.0% (corresponding to the traverse range)	0.0%
P08.17	Traverse boost time	0.1–3600.0s	5.0s
P08.18	Traverse declining time	0.1–3600.0s	5.0s

7.17 Pulse counter

Goodrive300 series VFDs support pulse counter which can input counting pulse through HDI terminal. When the actual length is longer than or equal to the set length, the digital output terminal can output length arrival pulse signal and the corresponding length will clear automatically.

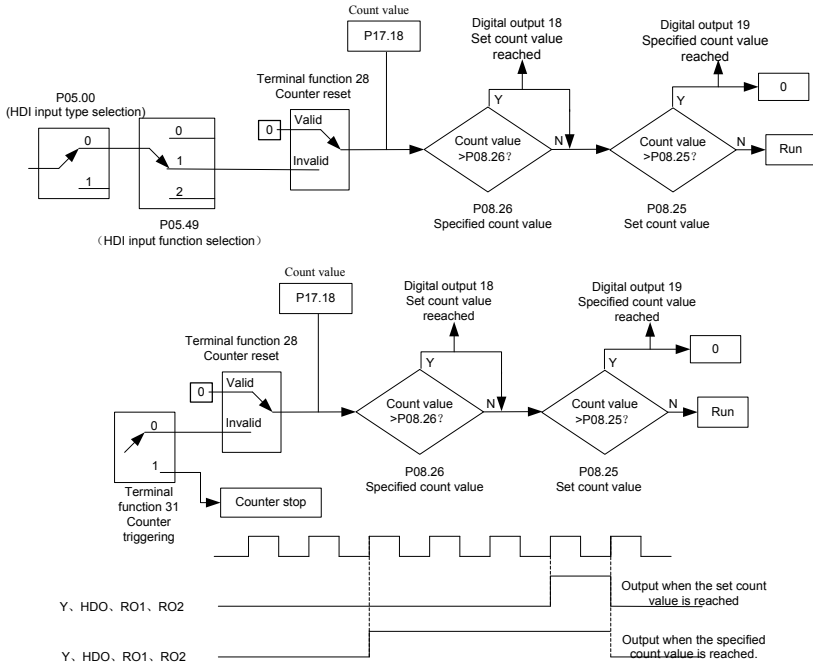

Function code	Name	Detailed instruction of parameters	Default value
P05.00	HDI input selection	0: High-speed pulse input. 1: Digital input.	0
P05.49	HDI high-speed pulse input function selection	0: Frequency setting input 1: Counter input 2: Length counting input	0
P05.01–P05.09	Digital input function selection	28:Counter reset 31:Counter trigger	
P06.01–P06.04	Digital output function selection	18: Set count value reached 19: Specified count value reached	
P08.25	Set count value	P08.26–65535	0
P08.26	Specified count value	0–P08.25	0
P17.18	Count value	0–65535	0

7.18 Fixed-length control

Goodrive300 series VFDs support fixed-length control function which can input length counting pulse through HDI, and then count the actual length according to the internal counting formula. If the actual

length is longer than or equal to the set length, the digital output terminal can output the length arrival pulse signal of 200ms and the corresponding length will clear automatically.

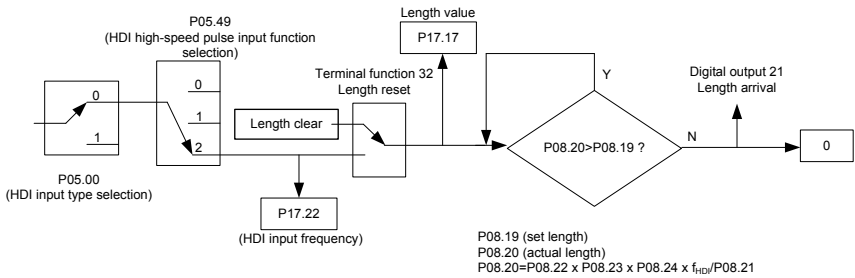

Note: The parameter of "Length arrival" is related to pulse output and the lasting time is 200ms.

Function code	Name	Detailed instruction of parameters	Default value
P05.00	HDI input selection	0: High pulse input. 1: Digital input.	0
P05.49	HDI high-speed pulse input function selection	0: Frequency setting input 1: Counter input 2: Length counting input	0
P05.01–P05.09	Digital input function selection	32: Length reset	
P06.01–P06.04	Digital output function selection	21: Length arrival	
P08.19	Set length	0–65535m	0
P08.20	Actual length	0–65535m	0
P08.21	Pulse per rotation	1–10000	1
P08.22	Alxe perimeter	0.01–100.00cm	10.00
P08.23	Length ratio	0.001–10.000	1.000
P08.24	Length correcting coefficient	0.001–1.000	1.000
P17.17	Length	0–65535	0
P17.22	HDI input frequency	Display HDI input frequency Range: 0.00–50.00kHz	0.00kHz

7.19 Fault procedure

Goodrive300 series VFDs provide sufficient fault procedure information for the convenience of user’s application.

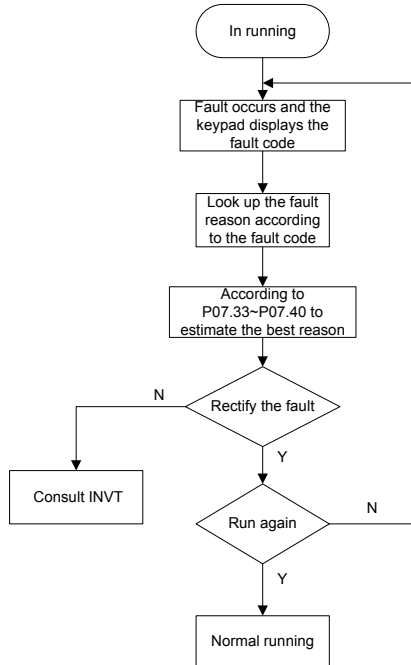

Related parameters

Function code	Name	Detailed instruction of parameters	Default value
P07.27	Type of current fault	0: No fault	0
P07.28	Type of last fault	1: Inverter unit U phase protection (OUT1)	
P07.29	Type of last but one fault	2: Inverter unit V phase protection (OUT2)	
P07.30	Type of last but two fault	3: Inverter unit W phase protection (OUT3)	
P07.31	Type of last but three fault	4: OC1	
P07.32	Type of last but four fault	5: OC2	
		6: OC3	
		7: OV1	
		8: OV2	
		9: OV3	
		10:UV	
		11: Motor overload (OL1)	
		12:The VFD overload (OL2)	

Function code	Name	Detailed instruction of parameters	Default value
		13: Input side phase loss (SPI) 14: Output side phase loss (SPO) 15: Overheat of the rectifier module (OH1) 16: Overheat fault of the inverter module (OH2) 17: External fault (EF) 18: 485 communication fault (CE) 19: Current detection fault (ItE) 20: Motor antotune fault (tE) 21: EEPROM operation fault (EEP) 22: PID response offline fault (PIDE) 23: Braking unit fault (bCE) 24: Running time arrival (END) 25: Electrical overload (OL3) 26: Panel communication fault (PCE) 27: Parameter uploading fault (UPE) 28: Parameter downloading fault (DNE) 29: PROFIBUS communication fault (E-DP) 30: Ethernet communication fault (E-NET) 31: CANopen communication fault (E-CAN) 32: Grounding short circuit fault 1 (ETH1) 33: Grounding short circuit fault 2 (ETH2) 34: Speed deviation fault (dEu) 35: Maladjustment (STo) 36: Undervoltage fault (LL)	
P07.33	Running frequency at current fault		0.00Hz
P07.34	Ramp reference frequency at current fault		0.00Hz
P07.35	Output voltage at current fault		0V
P07.36	Output current at current fault		0.0A
P07.37	Bus voltage at current		0.0V

Function code	Name	Detailed instruction of parameters	Default value
	fault		
P07.38	The Max. temperature at current fault		0.0°C
P07.39	Input terminals state at current fault		0
P07.40	Output terminals state at current fault		0
P07.41	Running frequency at last fault		0.00Hz
P07.42	Ramp reference frequency at last fault		0.00Hz
P07.43	Output voltage at last fault		0V
P07.44	The output current at last fault		0.0A
P07.45	Bus voltage at last fault		0.0V
P07.46	The Max. temperature at last fault		0.0°C
P07.47	Input terminals state at last fault		0
P07.48	Output terminals state at last fault		0
P07.49	Running frequency at last but one fault		0.00Hz
P07.50	Output voltage at last but one faults		0.00Hz
P07.51	Output current at last but one faults		0V
P07.52	Output current at last but one fault		0.0A
P07.53	Bus voltage at last but one fault		0.0V
P07.54	The Max. temperature at last but one fault		0.0°C
P07.55	Input terminals state at last but one fault		0
P07.56	Output terminals state at last but one fault		0

Chapter 8 Fault tracking

8.1 What this chapter contains

This chapter describes how to reset faults and view fault history. It also lists all alarm and fault messages including the possible cause and corrective actions.



- Only qualified electricians are allowed to maintain the VFD. Read the safety instructions in Chapter 1 "Safety precautions" before working on the VFD.

8.2 Alarm and fault indications

Fault is indicated by LEDs. See Chapter 5 "Keypad operation procedure". When **TRIP** light is on, an alarm or fault message on the panel display indicates abnormal VFD state. Using the information given in this chapter, most alarm and fault cause can be identified and corrected. If not, contact with the INVT office.

8.3 How to reset

The VFD can be reset by pressing the keypad key **[STOP/RST]**, through digital input, or by switching the power light. When the fault has been removed, the motor can be restarted.

8.4 Fault history

Function codes P07.27–P07.32 store 6 recent faults. Function codes P07.33–P07.40, P07.41–P7.48, P07.49–P07.56 show drive operation data at the time the latest 3 faults occurred.

8.5 Fault instruction and solution

Do as the following after the VFD fault:

1. Check to ensure there is nothing wrong with the keypad. If not, please contact with the local INVT office.
2. If there is nothing wrong, please check P07 and ensure the corresponding recorded fault parameters to confirm the real state when the current fault occurs by all parameters.
3. See the following table for detailed solution and check the corresponding abnormal state.
4. Eliminate the fault and ask for relative help.
5. Check to eliminate the fault and carry out fault reset to run the VFD.

8.5.1 VFD faults and troubleshooting resolutions

Code	Fault	Cause	Solution
OUt1	Inverter unit U phase protection	<ul style="list-style-type: none"> ●The acceleration is too fast ●There is damage to the internal to IGBT of the phase 	<ul style="list-style-type: none"> ●Increase the ACC time ●Change the power unit ●Check the driving wires
OUt2	Inverter unit V phase protection	<ul style="list-style-type: none"> ●Misoperation is caused by interference. ●The connection of the driving 	<ul style="list-style-type: none"> ●Check if there is strong interference to the external equipment

Code	Fault	Cause	Solution
OUt3	Inverter unit W phase protection	wires is not good ●Short-to-ground occurs.	
OV1	Accelerating overvoltage	<ul style="list-style-type: none"> ●The input voltage is abnormal ●There is large energy feedback ●No braking components ●Braking energy is not open 	<ul style="list-style-type: none"> ●Check the input power ●Check if the DEC time of the load is too short or the VFD starts during the rotation of the motor or it needs to increase the energy consumption components ●Install the dynamic braking components ●Check the setting of related function codes
OV2	Decelerating overvoltage		
OV3	Constant overvoltage		
OC1	Accelerating overcurrent	●The acceleration or deceleration is too fast	<ul style="list-style-type: none"> ●Increase the ACC/DEC time ●Check the input power ●Select the VFD with a larger power ●Check if the load is short circuited (the grounding short circuited or the wire short circuited) or the rotation is not smooth ●Check the output configuration. ●Check if there is strong interference ●Check the setting of related function codes
OC2	Decelerating overcurrent	●The voltage of the grid is too low	
OC3	Constant overcurrent	<ul style="list-style-type: none"> ●The power of the VFD is too low ●The load transients or is abnormal ●The grounding is short circuited or the output is phase loss ●There is strong external interference ●The overvoltage stall protection is not open 	
UV	Bus undervoltage fault	<ul style="list-style-type: none"> ●The voltage of the grid is too low ●The overvoltage stall protection is not open 	<ul style="list-style-type: none"> ●Check the input power of the grid ●Check the setting of related function codes
OL1	Motor overload	<ul style="list-style-type: none"> ●The voltage of the grid is too low ●The rated current of the motor is not correctly set ●The motor stall or load transients is too strong 	<ul style="list-style-type: none"> ●Check the power of the grid ●Reset the rated current of the motor ●Check the load and adjust the torque lift
OL2	VFD overload	●The acceleration is too fast	●Increase the ACC time

Code	Fault	Cause	Solution
		<ul style="list-style-type: none"> ●Reset the rotating motor ●The voltage of the grid is too low. ●The load is too heavy. ●The motor power is too small 	<ul style="list-style-type: none"> ●Avoid the restarting after stopping. ●Check the power of the grid ●Select a VFD with bigger power. ●Select a proper motor.
SPI	Input phase loss	●Phase loss or fluctuation of input R,S,T	<ul style="list-style-type: none"> ●Check input power ●Check installation distribution
SPO	Output phase loss	●U,V,W phase loss input (or serious asymmetrical three phase of the load)	<ul style="list-style-type: none"> ●Check the output distribution ●Check the motor and cable
OH1	Rectifier module overheated	<ul style="list-style-type: none"> ●Air duct jam or fan damage ●Ambient temperature is too high. 	<ul style="list-style-type: none"> ●Dredge the vent duct or replace the fan ●Lower the ambient temperature
OH2	Inverter module overheated	●The time of overload running is too long.	
EF	External fault	●SI external fault input terminals action	●Check the external device input
CE	485 communication fault	<ul style="list-style-type: none"> ●The baud rate setting is incorrect. ●Fault occurs to the communication wiring. ●The communication address is wrong. ●There is strong interference to the communication. 	<ul style="list-style-type: none"> ●Set proper baud rate ●Check the communication connection distribution ●Set proper communication address. ●Change or replace the connection distribution or improve the anti-interference capability.
ItE	Current-detecting fault	<ul style="list-style-type: none"> ●The connection of the control board is not good ●Hall components are broken ●The modifying circuit is abnormal. 	<ul style="list-style-type: none"> ●Check the connector and repatch ●Change the Hall ●Change the main control panel
tE	Motor-autotuning fault	<ul style="list-style-type: none"> ●The motor capacity does not comply with the VFD capability ●The rated parameter of the motor does not set correctly. ●The offset between the 	<ul style="list-style-type: none"> ●Change the VFD mode ●Set the ratedparameter according to the motor name plate ●Empty the motor load and reidentify

Code	Fault	Cause	Solution
		parameters from autotune and the standard parameter is huge ●Autotune overtime	●Check the motor connection and set the parameter. ●Check if the upper limit frequency is above 2/3 of the rated frequency.
EEP	EEPROM operation fault	●Error of controlling the write and read of the parameters ●Damage to EEPROM	●Press STOP/RST to reset ●Change the main control panel
PIDE	PID feedback outline fault	●PID feedback offline ●PID feedback source disappear	●Check the PID feedback signal ●Check the PID feedback source
bCE	Braking unit fault	●Braking circuit fault or damage to the braking pipes ●The external braking resistor is not sufficient	●Check the braking unit and change new braking pipe ●Increase the braking resistor
END	Running time arrival	●The actual running time of the VFD is above the internal setting running time.	●Ask for the supplier and adjust the setting running time.
OL3	Electrical overload	●The VFD will report overload pre-alarm according to the set value.	●Check the load and the overload pre-alarm point.
PCE	Keypad communication fault	●The connection of the keypad wires is not good or broken. ●The keypad wire is too long and affected by strong interference. ●There is circuit fault on the communication of the keypad and main board.	●Check the keypad wires and ensure whether there is mistake. ●Check the environment and avoid the interference source. ●Change the hardware and ask for service.
UPE	Parameters uploading fault	●The connection of the keypad wires is not good or broken. ●The keypad wire is too long and affected by strong interference. ●There is circuit fault on the communication of the keypad and main board.	●Check the keypad wires and ensure whether there is mistake. ●Change the hardware and ask for service. ●Change the hardware and ask for service.
DNE	Parameters downloading	●The connection of the keypad wires is not good or broken.	●Check the keypad wires and ensure whether there is mistake.

Code	Fault	Cause	Solution
	fault	<ul style="list-style-type: none"> ●The keypad wire is too long and affected by strong interference. ●There is mistake on the data storage of the keypad. 	<ul style="list-style-type: none"> ●Change the hardware and ask for service. ●Repack-up the data in the keypad.
E-DP	PROFIBUS communication fault	<ul style="list-style-type: none"> ●Communication address is not correct. ●Corresponding resistor is not dialed ●The files of main stop GSD does not set sound ●The peripheral interference is too large. 	<ul style="list-style-type: none"> ●Check related setting ●Check the surrounding environment, and eliminate interference effects.
E-NET	Ethernet communication fault	<ul style="list-style-type: none"> ●The Ethernet address is not set right. ●The Ethernet communication is not selected to right. ●The peripheral interference is too large. 	<ul style="list-style-type: none"> ●Check the related setting. ●Check the communication method selection. ●Check the surrounding environment, and eliminate interference effects.
E-CAN	CANopen communication fault	<ul style="list-style-type: none"> ●The connection is not sound ●Corresponding resistor is not dialed ●The communication baud rate is not matched ●The peripheral interference is too large. 	<ul style="list-style-type: none"> ●Check the connection ●Draw out the correspond resistor ●Set the same baud rate ●Check the surrounding environment, and eliminate interference effects.
ETH1	Grounding shortcut fault 1	<ul style="list-style-type: none"> ●The output of the VFD is short circuited with the ground. ●There is fault in the current detection circuit. ●The actual motor power sharply differs from the VFD power. 	<ul style="list-style-type: none"> ●Check if the connection of the motor is normal or not ●Change the hall ●Change the main control panel ●Set motor parameters correctly.
ETH2	Grounding shortcut fault 2	<ul style="list-style-type: none"> ●The output of the VFD is short circuited with the ground. ●There is fault in the current detection circuit. ●The actual motor power sharply differs from the VFD 	<ul style="list-style-type: none"> ●Check if the connection of the motor is normal or not ●Change the Hall ●Change the main control panel ●Set motor parameters correctly.

Code	Fault	Cause	Solution
		power.	
dEu	Speed deviation fault	<ul style="list-style-type: none"> ●The load is too heavy or stalled. 	<ul style="list-style-type: none"> ●Check the load and ensure it is normal. ●Increase the detection time. ●Check whether the control parameters are normal.
STo	Maladjustment fault	<ul style="list-style-type: none"> ●The control parameters of the synchronous motors not set properly. ●The autoturn parameter is not right. ●The VFD is not connected to the motor. 	<ul style="list-style-type: none"> ●Check the load and ensure it is normal. ●Check whether the control parameter is set properly or not. ●Increase the maladjustment detection time.
LL	Electronic underload fault	<ul style="list-style-type: none"> ●The VFD will report the underload pre-alarm according to the set value. 	<ul style="list-style-type: none"> ●Check the load and the underload pre-alarm point.

8.5.2 Other status

Code	State	Cause	Solution
PoFF	System power failure	The system is powered off or the bus voltage is too low.	Check the grid conditions.
	Failure of communication between the keypad and main control panel	The keypad is not properly connected.	Check the installation environment of the keypad.

8.6 Common fault analysis

8.6.1 The motor does not work

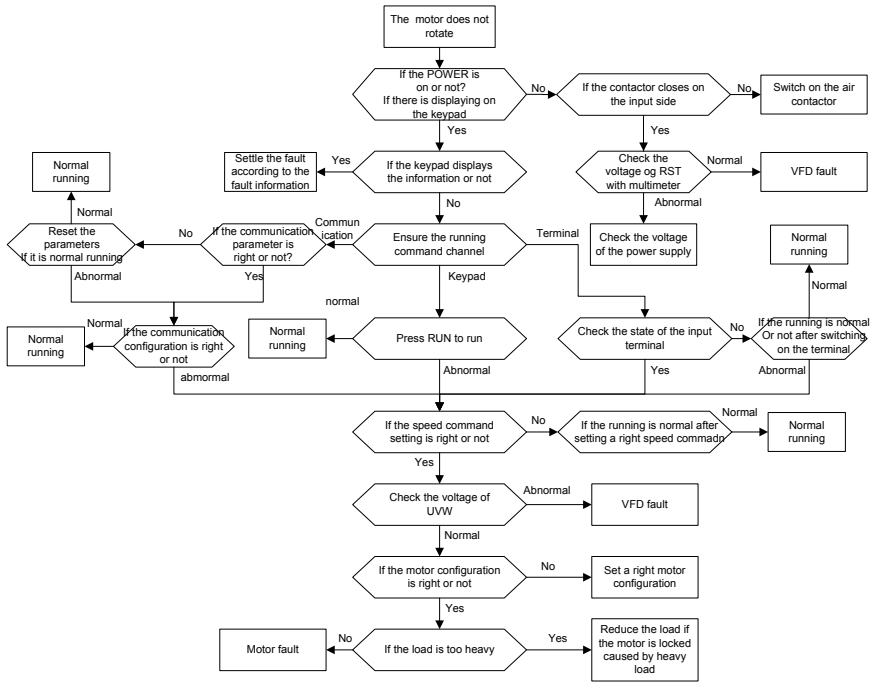

8.6.2 Motor vibration

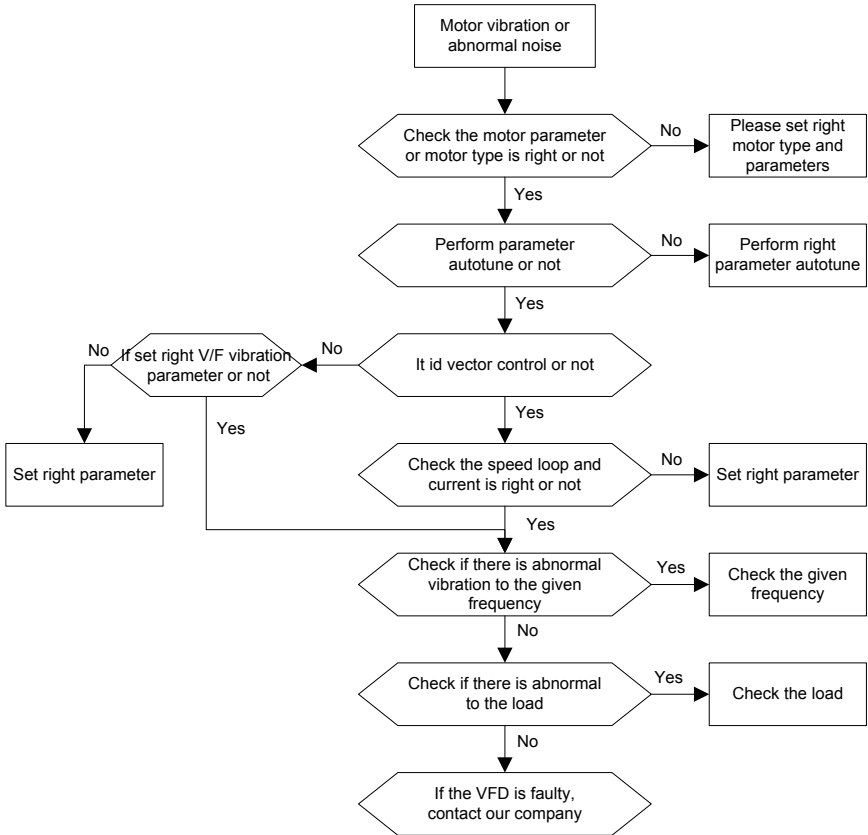

8.6.3 Overvoltage

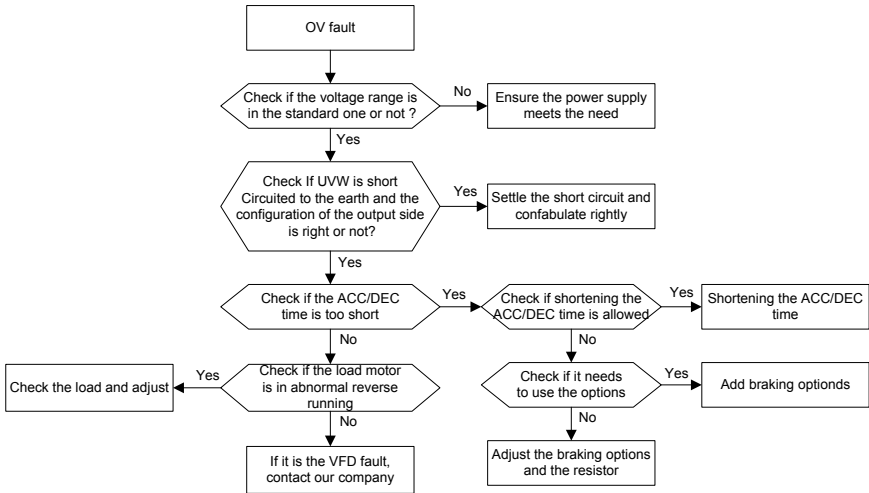

8.6.4 Undervoltage

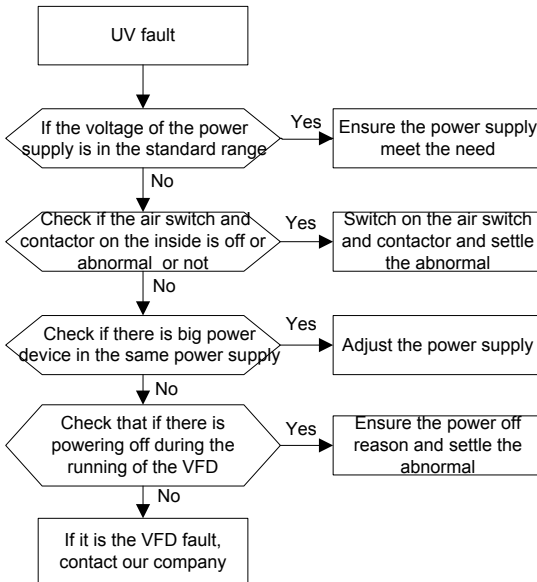

8.6.5 Abnormal heating of the motor

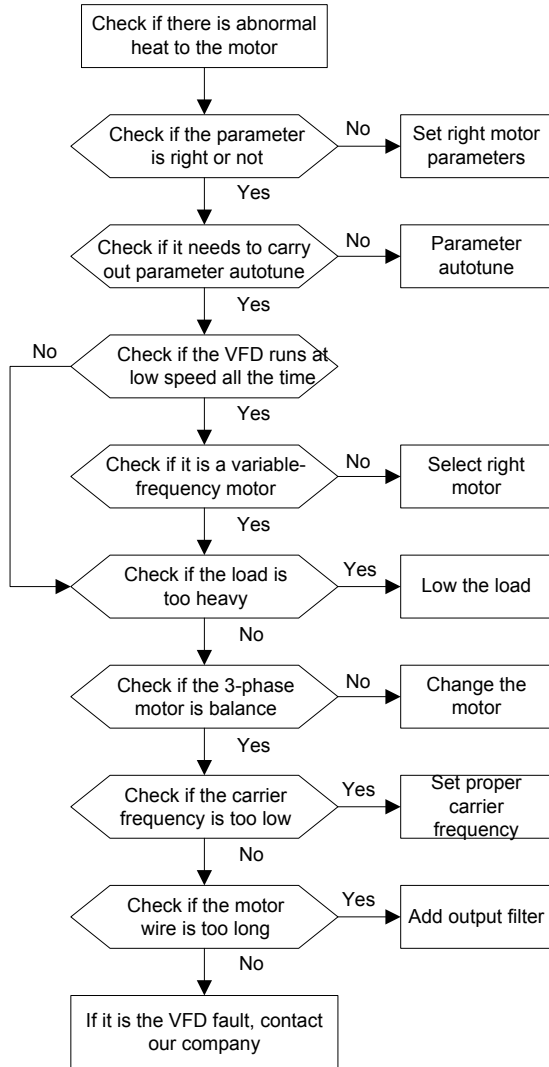

8.6.6 Overheat of the VFD

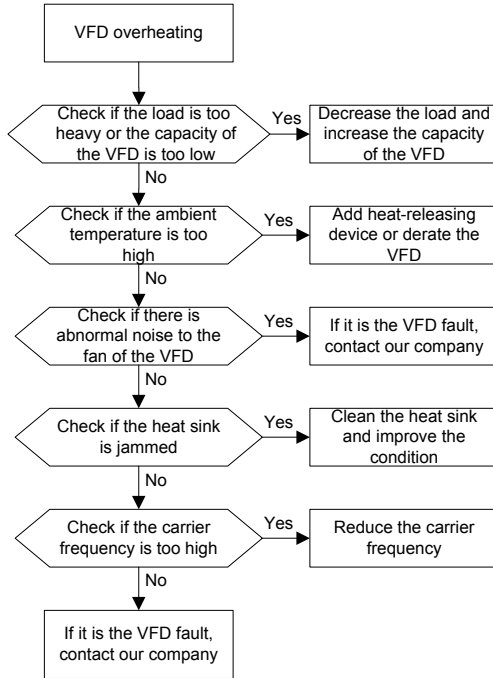

8.6.7 Motor stall during ACC

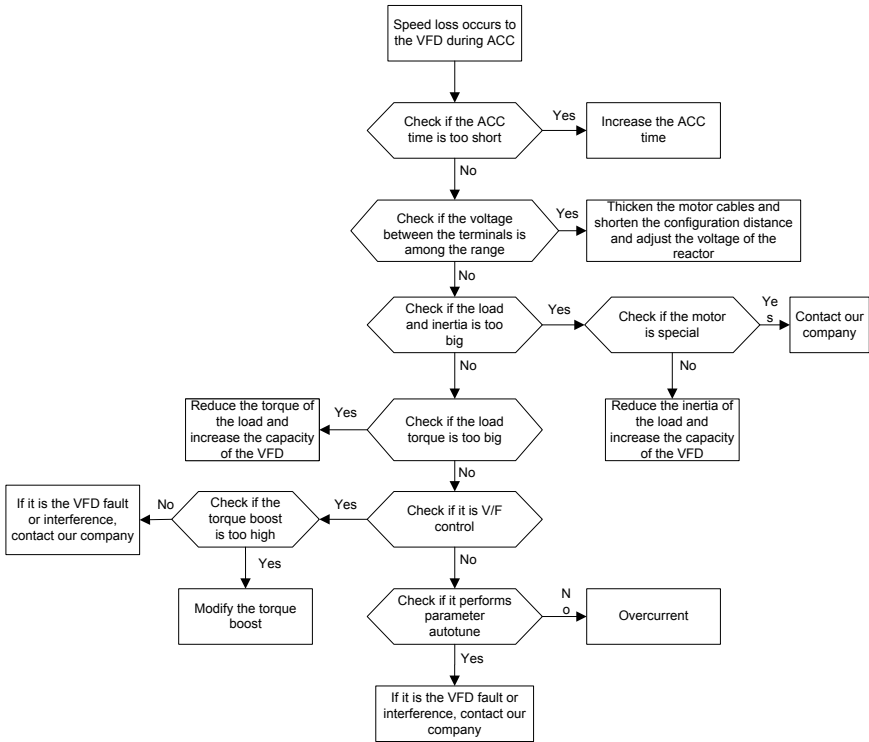

8.6.8 Overcurrent

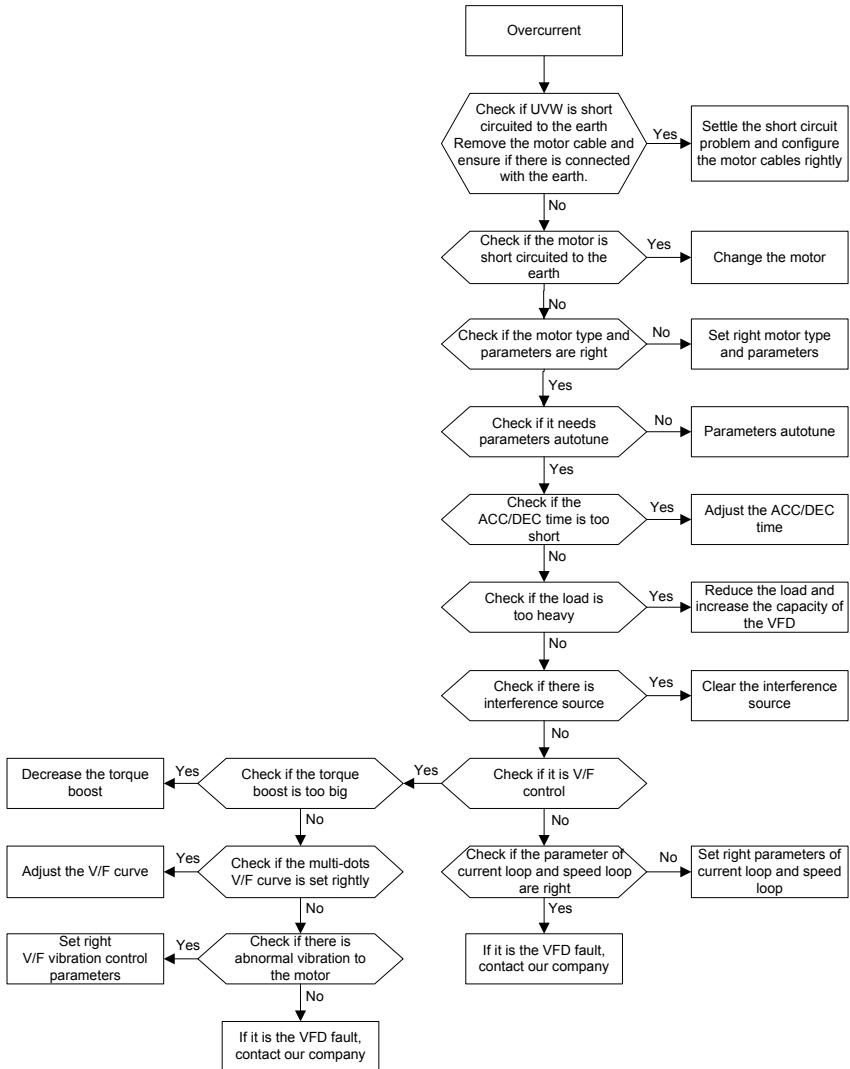

Chapter 9 Maintenance and hardware fault diagnostics

9.1 What this chapter contains

The chapter contains preventive maintenance instructions of the VFD.

9.2 Maintenance intervals

If installed in an appropriate environment, the VFD requires very little maintenance. The table lists the routine maintenance intervals recommended by INVT.

Checking		Item	Method	Criterion
Ambient environment		Check the ambient temperature, humidity and vibration and ensure there is no dust, gas, oil fog and water drop.	Visual examination and instrument test	Conforming to the manual
		Ensure there are no tools or other foreign or dangerous objects	Visual examination	There are no tools or dangerous objects.
Voltage		Ensure the main circuit and control circuit are normal.	Measurement by millimeter	Conforming to the manual
Keypad		Ensure the display is clear enough	Visual examination	The characters are displayed normally.
		Ensure the characters are displayed totally	Visual examination	Conforming to the manual
Main circuit	For public use	Ensure the screws are tightened security	Tighten up	NA
		Ensure there is no distortion, crackles, damage or color-changing caused by overheating and aging to the machine and insulator.	Visual examination	NA
		Ensure there is no dust and dirtiness	Visual examination	NA Note: if the color of the copper blocks change, it does not mean that there is something wrong with the features.
	The lead of the conductors	Ensure that there is no distortion or color-changing of the conductors caused by	Visual examination	NA

Checking	Item	Method	Criterion	
	overheating.			
	Ensure that there are no crackles or color-changing of the protective layers.	Visual examination	NA	
	Terminals seat	Ensure that there is no damage	Visual examination	NA
	Filter capacitors	Ensure that there is no weeping, color-changing, crackles and cassis expansion.	Visual examination	NA
		Ensure the safety valve is in the right place.	Estimate the usage time according to the maintenance or measure the static capacity.	NA
		If necessary, measure the static capacity.	Measure the capacity by instruments.	The static capacity is above or equal to the original value × 0.85.
	Resistors	Ensure whether there is replacement and splitting caused by overheating.	Smelling and visual examination	NA
		Ensure that there is no offline.	Visual examination or remove one ending to coagulate or measure with multimeters	The resistors are in ±10% of the standard value.
	Transformers and reactors	Ensure there is no abnormal vibration, noise and smelling.	Hearing, smelling and visual examination	NA
	Electromagnetism contactors and relays	Ensure whether there is vibration noise in the workrooms.	Hearing	NA
Ensure the contactor is good enough.		Visual examination	NA	
Control circuit	PCB and plugs	Ensure there are no loose screws and contactors.	Fasten up	NA
		Ensure there is no smelling and color-changing.	Smelling and visual examination	NA

Checking		Item	Method	Criterion
		Ensure there are no crackles, damage distortion and rust.	Visual examination	NA
		Ensure there is no weeping and distortion to the capacitors.	Visual examination or estimate the usage time according to the maintenance information	NA
Cooling system	Cooling fan	Estimate whether there is abnormal noise and vibration.	Hearing and Visual examination or rotate with hand	Stable rotation
		Estimate there is no losses screw.	Tighten up	NA
		Ensure there is no color-changing caused by overheating.	Visual examination or estimate the usage time according to the maintenance information	NA
	Ventilating duct	Ensure whether there is stuff or foreign objection in the cooling fan, air vent.	Visual examination	NA

Consult the local service representative for more details on the maintenance. Visit the official website.

9.3 Cooling fan

The VFD's cooling fan has a minimum life span of 25,000 operating hours. The actual life span depends on the VFD usage and ambient temperature.

The operating hours can be found through P07.14.

Fan failure can be predicted by the increasing noise from the fan bearings. If the VFD is operated in a critical part of a process, fan replacement is recommended once these symptoms appear. Spare fans are also available.

9.3.1 Replacing the cooling fan

	<ul style="list-style-type: none"> Read and follow the instructions in Chapter 1 "Safety precautions". Ignoring the instructions would cause physical injury or death, or damage to the equipment.
---	---

1. Stop the VFD and disconnect it from the AC power source and wait for at least the time designated on the VFD.
2. Loose the fan cable from the clip (remove the shell for the VFDs of 380V 1.5–30kW).
3. Disconnect the fan cable.
4. Remove the fan.

5. Keep the wind direction of the fan consistent with that of the VFD, as shown below:

6. Restore power.

9.4 Capacitors

9.4.1 Capacitors reforming

The DC bus capacitors must be reformed according to the operation instruction if the VFD has been stored for a long time. The storing time is calculated from the delivery date.

Time	Operational principle
Less than 1 year	Operation without charging
1-2 years	Connect with the power for 1 hour before first ON command
2-3 years	Use power surge to charge for the VFD <ul style="list-style-type: none"> • charging 25% rated voltage for 30 minutes • charging 50% rated voltage for 30 minutes • charging 75% rated voltage for 30 minutes • charging 100% rated voltage for 30 minutes
More than 3 years	Use power surge to charge for the VFD <ul style="list-style-type: none"> • charging 25% rated voltage for 2 hours • charging 50% rated voltage for 2 hours • charging 75% rated voltage for 2 hours • charging 100% rated voltage for 2 hours

Use voltage-adjusting power supply to charge the VFD:

The right selection of the voltage-adjusting power supply depends on the supply power of the VFD. Single phase 220V AC/2A power surge is applied to the VFD of single/three-phase 220VAC. The VFD of single/three-phase 220V AC can apply single phase 220V AC/2A power surge (L+ to R, N to S or T). All DC bus capacitors can charge at the same time because there is one rectifier.

High-voltage VFD needs enough voltage (for example, 380V) during charging. The small capacitor power (2A is enough) can be used because the capacitor nearly does not need current when charging.

The operation method of VFD charging through resistors (LEDs):

The charging time is at least 60 minutes if charge the DC bus capacitor directly through supply power. This operation is available on normal temperature and no-load condition and the resistor should be serially connected in the 3-phase circuits of the power supply:

- a) 380V drive device: 1k/100W resistor. LED of 100W can be used when the power voltage is no more than 380V. But if used, the light may be off or weak during charging.
- b) 500V drive device: 1k/140W resistor
- c) 660V drive device: 1k/160W resistor

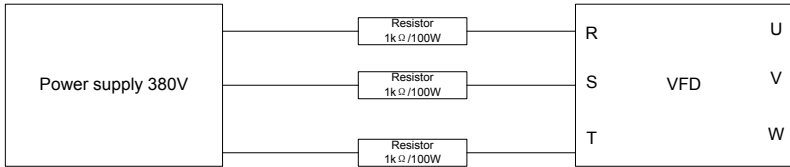

Figure 10-1 380V charging illustration of the drive device

9.4.2 Change electrolytic capacitors



- Read and follow the instructions in Chapter 1 "Safety precautions". Ignoring the instructions may cause physical injury or death, or damage to the equipment.

Change electrolytic capacitors if the working hours of electrolytic capacitors in the VFD are above 35000. Please contact with the local offices or dial our national service hotline (400-700-9997) for detailed operation.

9.5 Power cable



- Read and follow the instructions in Chapter 1 "Safety precautions". Ignoring the instructions may cause physical injury or death, or damage to the equipment.

1. Stop the drive and disconnect it from the power line. Wait for at least the time designated on the VFD.
2. Check the tightness of the power cable connections.
3. Restore power.

Chapter 10 Communication protocol

10.1 What this chapter contains

This chapter describes the communication protocol of Goodrive300 series VFDs.

The Goodrive300 series VFDs provide RS485 communication interface. It adopts international standard ModBus communication protocol to perform master-slave communication. The user can realize centralized control through PC/PLC, upper control PC, etc. (set the control command, running frequency of the VFD, modify relevant function codes, monitor and control the operating state and fault information of the VFD and so on) to adapt specific application requirements.

10.2 Brief introduction of Modbus protocol

Modbus protocol is a software protocol and common language which is applied in the electrical controller. With this protocol, the controller can communicate with other devices via network (the channel of signal transmission or the physical layer, such as RS485). And with this industrial standard, the controlling devices of different manufacturers can be connected to an industrial network for the convenient of being monitored.

There are two transmission modes for Modbus protocol: ASCII mode and RTU (Remote Terminal Units) mode. On one Modbus network, all devices should select same transmission mode and their basic parameters, such as baud rate, digital bit, check bit, and stopping bit should have no difference.

Modbus network is a controlling network with single-master and multiple slaves, which means that there is only one device performs as the master and the others are the slaves on one Modbus network. The master means the device which has active talking right to sent message to Modbus network for the controlling and inquiring to other devices. The slave means the passive device which sends data message to the Modbus network only after receiving the controlling or inquiring message (command) form the master (response). After the master sends message, there is a period of time left for the controlled or inquired slaves to response, which ensure there is only one slave sends message to the master at a time for the avoidance of singles impact.

Generally, the user can set PC, PLC, IPC and HMI as the masters to realize central control. Setting certain device as the master is a promise other than setting by a bottom or a switch or the device has a special message format. For example, when the upper monitor is running, if the operator clicks sending command bottom, the upper monitor can send command message actively even it cannot receive the message form other devices. In this case, the upper monitor is the master. And if the designer makes the VFD send the data only after receiving the command, then the VFD is the slave.

The master can communicate with any single slave or with all slaves. For the single-visiting command, the slave should feedback a response message; for the broadcasting message from the master, the slave does not need to feedback the response message.

10.3 Application of the VFD

The Modbus protocol of the VFD is RTU mode and the physical layer is RS485.

10.3.1 RS485

The interface of RS485 works on semiduplex and its data signal applies differential transmission which is called balance transmission, too. It uses twisted pairs, one of which is defined as A (+) and the other is defined as B (-). Generally, if the positive electrical level between sending drive A and B is among +2~+6V, it is logic "1", if the electrical level is among -2V~-6V, it is logic "0".

485+ on the terminal board corresponds to A and 485- to B.

Communication baud rate means the binary bit number in one second. The unit is bit/s (bps). The higher the baud rate is, the quicker the transmission speed is and the weaker the anti-interference is. If the twisted pairs of 0.56mm(24AWG) is applied as the communication cables, the Max. Transmission distance is as below:

Baud rate	Max. transmission distance	Baud rate	Max. transmission distance
2400BPS	1800m	9600BPS	800m
4800BPS	1200m	19200BPS	600m

It is recommended to use shield cables and make the shield layer as the grounding wires during RS485 remote communication.

In the cases with less devices and shorter distance, it is recommended to use 120Ω terminal resistor as the performance will be weakened if the distance increase even though the network can perform well without load resistor.

10.3.1.1 Single application

Figure 1 is the site Modbus connection figure of single VFD and PC. Generally, the computer does not have RS485 interface, the RS232 or USB interface of the computer should be converted into RS485 by converter. Connect the A terminal of RS485 to the 485+ terminal of the VFD and B to the 485-terminal. It is recommended to use the shield twisted pairs. When applying RS232-RS485 converter, if the RS232 interface of the computer is connected to the RS232 interface of the converter, the wire length should be as short as possible within the length of 15m. It is recommended to connect the RS232-RS485 converter to the computer directly. If using USB-RS485 converter, the wire should be as short as possible, too.

Select a right interface to the upper monitor of the computer (select the interface of RS232-RS485 converter, such as COM1) after the wiring and set the basic parameters such as communication baud rate and digital check bit to the same as the VFD.

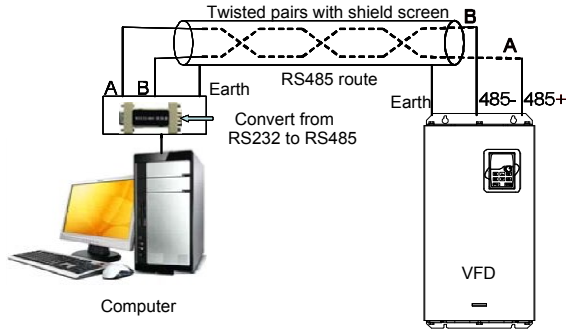

Figure 10-1 RS485 physical connection in single application

10.3.1.2 Multi-application

In the real multi-application, the chrysanthemum connection and star connection are commonly used.

Chrysanthemum chain connection is required in the RS485 industrial fieldbus standards. The two ends are connected to terminal resistors of 120Ω which is shown as figure 2. Figure 3 is the simply connection figure and figure 4 is the real application figure.

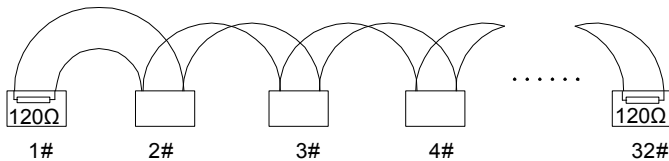

Figure 10-2 Chrysanthemum connection

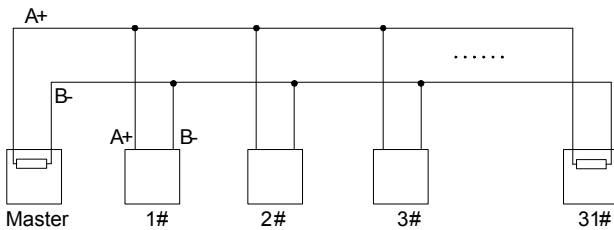

Figure 10-3 Chrysanthemum connection

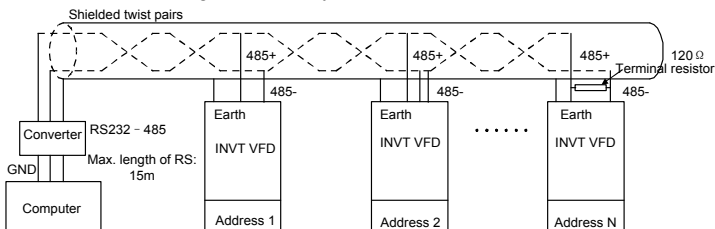

Figure 10-4 Chrysanthemum connection applications

Figure 5 is the star connection. Terminal resistor should be connected to the two devices which have the longest distance. (1# and 15#device)

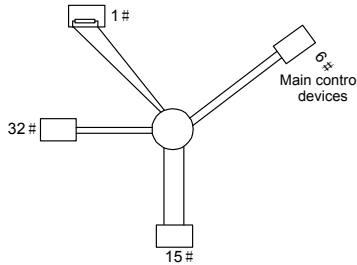

Figure 10-5 star connection

It is recommended to use shield cables in multiple connection. The basic parameter of the devices, such as baud rate and digital check bit in RS485 should be the same and there should be no repeated address.

10.3.2 RTU mode

10.3.2.1 RTU communication frame format

If the controller is set to communicate by RTU mode in Modbus network every 8bit byte in the message includes two 4Bit hex characters. Compared with ACSII mode, this mode can send more data at the same baud rate.

Code system

- 1 start bit
- 7 or 8 digital bit, the minimum valid bit can be sent firstly. Every 8 bit frame includes two hex characters (0...9, A...F)
- 1 even/odd check bit . If there is no checkout, the even/odd check bit is inexistent.
- 1 end bit (with checkout), 2 Bit (no checkout)

Error detection field

- CRC

The data format is illustrated as below:

11-bit character frame (BIT1–BIT8 are the data bits)

Start bit	BIT1	BIT2	BIT3	BIT4	BIT5	BIT6	BIT7	BIT8	Check bit	End bit
-----------	------	------	------	------	------	------	------	------	-----------	---------

10-bit character frame (BIT1–BIT7 are the data bits)

Start bit	BIT1	BIT2	BIT3	BIT4	BIT5	BIT6	BIT7	Check bit	End bit
-----------	------	------	------	------	------	------	------	-----------	---------

In one character frame, the digital bit takes effect. The start bit, check bit and end bit is used to send the digital bit right to the other device. The digital bit, even/odd checkout and end bit should be set as

the same in real application.

The Modbus minimum idle time between frames should be no less than 3.5 bytes. The network device is detecting, even during the interval time, the network bus. When the first field (the address field) is received, the corresponding device decodes next transmitting character. When the interval time is at least 3.5 byte, the message ends.

The whole message frame in RTU mode is a continuous transmitting flow. If there is an interval time (more than 1.5 bytes) before the completion of the frame, the receiving device will renew the uncompleted message and suppose the next byte as the address field of the new message. As such, if the new message follows the previous one within the interval time of 3.5 bytes, the receiving device will deal with it as the same with the previous message. If these two phenomena all happen during the transmission, the CRC will generate a fault message to respond to the sending devices.

The standard structure of RTU frame:

START	T1-T2-T3-T4(transmission time of 3.5 bytes)
ADDR	Communication address: 0–247 (decimal system) (0 is the broadcast address)
CMD	03H:read slave parameters 06H:write slave parameters
DATA (N-1) ... DATA (0)	The data of 2×N bytes are the main content of the communication as well as the core of data exchanging
CRC CHK low bit	Detection value:CRC (16BIT)
CRC CHK high bit	
END	T1-T2-T3-T4 (transmission time of 3.5 bytes)

10.3.2.2 RTU communication frame error checkout

Various factors (such as electromagnetic interference) may cause error in the data transmission. For example, if the sending message is a logic "1", A-B potential difference on RS485 should be 6V, but in reality, it may be -6V because of electromagnetic interference, and then the other devices take the sent message as logic "0". If there is no error checkout, the receiving devices will not find the message is wrong and they may give incorrect response which cause serious result. So the checkout is essential to the message.

The theme of checkout is that: the sender calculate the sending data according to a fixed formula, and then send the result with the message. When the receiver gets this message, they will calculate another result according to the same method and compare it with the sending one. If two results are the same, the message is correct. If not, the message is incorrect.

The error checkout of the frame can be divided into two parts: the bit checkout of the byte and the whole data checkout of the frame (CRC check).

Bit checkout of the byte

The user can select different bit checkouts or non-checkout, which impacts the check bit setting of each byte.

The definition of even checkout: add an even check bit before the data transmission to illustrate the number of "1" in the data transmission is odd number or even number. When it is even, the check byte is "0", otherwise, the check byte is "1". This method is used to stabilize the parity of the data.

The definition of odd checkout: add an odd check bit before the data transmission to illustrate the number of "1" in the data transmission is odd number or even number. When it is odd, the check byte is "0", otherwise, the check byte is "1". This method is used to stabilize the parity of the data.

For example, when transmitting "11001110", there are five "1" in the data. If the even checkout is applied, the even check bit is "1"; if the odd checkout is applied; the odd check bit is "0". The even and odd check bit is calculated on the check bit position of the frame. And the receiving devices also carry out even and odd checkout. If the parity of the receiving data is different from the setting value, there is an error in the communication.

CRC check

The checkout uses RTU frame format. The frame includes the frame error detection field which is based on the CRC calculation method. The CRC field is two bytes, including 16 figure binary values. It is added into the frame after calculated by transmitting device. The receiving device recalculates the CRC of the received frame and compares them with the value in the received CRC field. If the two CRC values are different, there is an error in the communication.

During CRC, $0 \times \text{FFFF}$ will be stored. And then, deal with the continuous 6-above bytes in the frame and the value in the register. Only the 8Bit data in every character is effective to CRC, while the start bit, the end and the odd and even check bit is ineffective.

The calculation of CRC applies the international standard CRC checkout principles. When the user is editing CRC calculation, he can refer to the related standard CRC calculation to write the required CRC calculation program.

Here provided a simple function of CRC calculation for the reference (programmed with C language):

```
unsigned int crc_cal_value(unsigned char *data_value,unsigned char data_length)
```

```
{
int i;
unsigned int crc_value=0xffff;
while(data_length--)
{   crc_value^=*data_value++;
    for(i=0;i<8;i++)
    {
if(crc_value&0x0001)crc_value=(crc_value>>1)^0xa001;
```

```

        else crc_value=crc_value>>1;
    }    }
return(crc_value);
}

```

In ladder logic, CKSM calculated the CRC value according to the frame with the table inquiry. The method is advanced with easy program and quick calculation speed. But the ROM space the program occupied is huge. So use it with caution according to the program required space.

10.4 RTU command code and communication data illustration

10.4.1 Command code: 03H

03H (correspond to binary 0000 0011), read N words (Word)(Max. continuous reading is 16 words)

Command code 03H means that if the master read data form the VFD, the reading number depends on the "data number" in the command code. The Max. continuous reading number is 16 and the parameter address should be continuous. The byte length of every data is 2 (one word). The following command format is illustrated by hex (a number with "H" means hex) and one hex occupies one byte.

The command code is used to read the working stage of the VFD.

For example, read continuous 2 data content from 0004H from the VFD with the address of 01H (read the content of data address of 0004H and 0005H), the frame structure is as below:

RTU master command message (from the master to the VFD)

START	T1-T2-T3-T4 (transmission time of 3.5 bytes)
ADDR	01H
CMD	03H
High bit of the start bit	00H
Low bit of the start bit	04H
High bit of data number	00H
Low bit of data number	02H
Low bit of CRC	85H
High bit of CRC	CAH
END	T1-T2-T3-T4 (transmission time of 3.5 bytes)

T1-T2-T3-T4 between START and END is to provide at least the time of 3.5 bytes as the leisure time and distinguish two messages for the avoidance of taking two messages as one message.

ADDR = 01H means the command message is sent to the VFD with the address of 01H and ADDR occupies one byte

CMD=03H means the command message is sent to read data form the VFD and CMD occupies one byte

"Start address" means reading data form the address and it occupies 2 bytes with the fact that the

high bit is in the front and the low bit is in the behind.

"Data number" means the reading data number with the unit of word. If the "start address" is 0004H and the "data number" is 0002H, the data of 0004H and 0005H will be read.

CRC occupies 2 bytes with the fact that the high bit is in the front and the low bit is in the behind.

RTU slave response message (from the VFD to the master)

START	T1-T2-T3-T4 (transmission time of 3.5 bytes)
ADDR	01H
CMD	03H
Byte number	04H
Data high bit of address 0004H	13H
Data low bit of address 0004H	88H
Data high bit of address 0005H	00H
Data low bit of address 0005H	00H
Low bit of CRC	7EH
High bit of CRC	9DH
END	T1-T2-T3-T4 (transmission time of 3.5 bytes)

The meaning of the response is that:

ADDR = 01H means the command message is sent to the VFD with the address of 01H and ADDR occupies one byte

CMD=03H means the message is received from the VFD to the master for the response of reading command and CMD occupies one byte

"Byte number" means all byte number from the byte (excluding the byte) to CRC byte (excluding the byte). 04 means there are 4 byte of data from the "byte number" to "CRC CHK low bit", which are "digital address 0004H high bit", "digital address 0004H low bit", "digital address 0005H high bit" and "digital address 0005H low bit".

There are 2 bytes stored in one data with the fact that the high bit is in the front and the low bit is in the behind of the message, the data of data address 0004H is 1388H, and the data of data address 0005H is 0000H.

CRC occupies 2 bytes with the fact that the high bit is in the front and the low bit is in the behind.

10.4.2 Command code: 06H

06H (correspond to binary 0000 0110), write one word (Word)

The command means that the master write data to the VFD and one command can write one data other than multiple dates. The effect is to change the working mode of the VFD.

For example, write 5000 (1388H) to 0004H from the VFD with the address of 02H, the frame structure is as below:

RTU master command message (from the master to the VFD)

START	T1-T2-T3-T4 (transmission time of 3.5 bytes)
ADDR	02H
CMD	06H
High bit of writing data address	00H
Low bit of writing data address	04H
Data content	13H
Data content	88H
Low bit of CRC	C5H
High bit of CRC	6EH
END	T1-T2-T3-T4 (transmission time of 3.5 bytes)

RTU slave response message (from the VFD to the master)

START	T1-T2-T3-T4 (transmission time of 3.5 bytes)
ADDR	02H
CMD	06H
High bit of writing data address	00H
Low bit of writing data address	04H
High bit of data content	13H
Low bit of data content	88H
Low bit of CRC	C5H
High bit of CRC	6EH
END	T1-T2-T3-T4 (transmission time of 3.5 bytes)

Note: section 10.2 and 10.3 mainly describe the command format, and the detailed application will be mentioned in 10.8 with examples.

10.4.3 Command code 08H for diagnosis

Meaning of sub-function codes

Sub-function Code	Description
0000	Return to inquire information data

For example: The inquiry information string is same as the response information string when the loop detection to address 01H of driver is carried out.

The RTU request command is:

START	T1-T2-T3-T4 (transmission time of 3.5 bytes)
ADDR	01H
CMD	08H
High bit of sub-function code	00H
Low bit of sub-function code	00H

High bit of data content	12H
Low bit of data content	ABH
Low bit of CRC	ADH
High bit of CRC	14H
END	T1-T2-T3-T4 (transmission time of 3.5 bytes)

The RTU response command is:

START	T1-T2-T3-T4 (transmission time of 3.5 bytes)
ADDR	01H
CMD	08H
High bit of sub-function code	00H
Low bit of sub-function code	00H
High bit of data content	12H
Low bit of data content	ABH
Low bit of CRC	ADH
High bit of CRC	14H
END	T1-T2-T3-T4 (transmission time of 3.5 bytes)

10.4.4 Command code: 10H, continuous writing

Command code 10H means that if the master writes data to the VFD, the data number depends on the "data number" in the command code. The Max. continuous reading number is 16.

For example, write 5000(1388H) to 0004H of the VFD whose slave address is 02H and 50(0032H) to 0005H, the frame structure is as below:

The RTU request command is:

START	T1-T2-T3-T4 (transmission time of 3.5 bytes)
ADDR	02H
CMD	10H
High bit of write data	00H
Low bit of write data	04H
High bit of data number	00H
Low bit of data number	02H
Byte number	04H
High bit of data 0004H	13H
Low bit of data 0004H	88H
High bit of data 0005H	00H
Low bit of data 0005H	32H
Low bit of CRC	C5H

High bit of CRC	6EH
END	T1-T2-T3-T4 (transmission time of 3.5 bytes)

The RTU response command is:

START	T1-T2-T3-T4 (transmission time of 3.5 bytes)
ADDR	02H
CMD	10H
High bit of write data	00H
Low bit of write data	04H
High bit of data number	00H
Low bit of data number	02H
Low bit of CRC	C5H
High bit of CRC	6EH
END	T1-T2-T3-T4 (transmission time of 3.5 bytes)

10.4.5 The definition of data address

The address definition of the communication data in this part is to control the running of the VFD and get the state information and related function parameters of the VFD.

10.4.5.1 Function code address representation rules

The parameter address occupies 2 bytes with the fact that the high bit is in the front and the low bit is in the behind. The range of high and low byte are: high byte—00–ffH; low byte—00–ffH. The high byte is the group number before the radix point of the function code and the low byte is the number after the radix point. But both the high byte and the low byte should be changed into hex. For example P05.06, the group number before the radix point of the function code is 05, then the high bit of the parameter is 05, the number after the radix point 06, then the low bit of the parameter is 06, then the function code address is 0506H and the parameter address of P10.01 is 0A01H.

Function code	Name	Description	Setting range	Default value	Modify	Serial No.
P10.00	Simple PLC	0: Stop after running once 1: Run at the final value after running once 2: Cycle running	0 - 2	0	<input type="radio"/>	354.
P10.01	Simple PLC memory	0: Power loss without memory 1: Power loss with memory	0 - 1	0	<input type="radio"/>	355.

Note: P29 group is the factory parameter which cannot be read or changed. Some parameters cannot be changed when the VFD is in the running state and some parameters cannot be changed in any state. The setting range, unit and related instructions should be paid attention to when modifying the function code parameters.

Besides, EEPROM is stocked frequently, which may shorten the usage time of EEPROM. For users,

some functions are not necessary to be stocked on the communication mode. The needs can be met on by changing the value in RAM. Changing the high bit of the function code form 0 to 1 can also realize the function. For example, the function code P00.07 is not stocked into EEPROM. Only by changing the value in RAM can set the address to 8007H. This address can only be used in writing RAM other than reading. If it is used to read, it is an invalid address.

10.4.5.2 The address instruction of other function in Modbus

The master can operate on the parameters of the VFD as well as control the VFD, such as running or stopping and monitoring the working state of the VFD.

Below is the parameter list of other functions:

Function instruction	Address definition	Data meaning instruction	R/W characteristics
Communication control command	2000H	0001H:forward running	R/W
		0002H:reverse running	
		0003H:forward jogging	
		0004H:reverse jogging	
		0005H:stop	
		0006H:coast to stop (emergency stop)	
		0007H:fault reset	
		0008H:jogging stop	
The address of communication setting	2001H	Communication setting frequency(0–Fmax(unit: 0.01Hz))	R/W
	2002H	PID given, range (0–1000, 1000 corresponds to100.0%)	R/W
	2003H	PID feedback, range (0–1000, 1000 corresponds to100.0%)	R/W
	2004H	Torque setting value (-3000–3000, 1000 corresponds to the 100.0% of the rated current of the motor)	R/W
	2005H	The upper limit frequency setting during forward rotation(0–Fmax(unit: 0.01Hz))	R/W
	2006H	The upper limit frequency setting during reverse rotation(0–Fmax(unit: 0.01Hz))	R/W
	2007H	The upper limit torque of electromotion torque (0–3000, 1000 corresponds to the 100.0% of the rated current of the motor)	R/W
	2008H	The upper limit torque of braking torque (0–3000, 1000 corresponds to the 100.0% of the rated current of the motor)	R/W

Function instruction	Address definition	Data meaning instruction	R/W characteristics
	2009H	Special control command word Bit0-1:=00: motor 1 =01: motor 2 =10: motor 3 =11: motor 4 Bit2:=1 torque control prohibit =0: torque control prohibit invalid Bit3:=1 power consumption clear =0:no power consumption clear Bit4:=1 pre-exciting enabling =0: pre-exciting disabling Bit5:=1 DC braking enabling =0: DC braking disabling	R/W
	200AH	Virtual input terminal command , range: 0x000-0x1FF	R/W
	200BH	Virtual output terminal command , range: 0x00-0x0F	R/W
	200CH	Voltage setting value (special for V/F separation) (0-1000, 1000 corresponds to the 100.0%)	R/W
	200DH	AO output setting 1 (-1000-1000, 1000 corresponds to 100.0%)	R/W
	200EH	AO output setting 2 (-1000-1000, 1000 corresponds to 100.0%)	R/W
SW 1 of the VFD	2100H	0001H:forward running	R
		0002H:forward running	
		0003H:stop	
		0004H:fault	
		0005H: POFF state	
		0006H: pre-exciting state	
SW 2 of the VFD	2101H	Bit0: =0: not ready for operation =1: ready for operation Bi1-2:=00: motor 1 =01: motor 2 =10: motor 3 =11: motor 4 Bit3: =0: asynchronous motor =1: synchronous motor Bit4: =0: pre-alarm without overload =1: overload pre-alarm Bit5- Bit6: =00: keypad control	R

Function instruction	Address definition	Data meaning instruction	R/W characteristics
		=01: terminal control =10: communication control	
Fault code of the VFD	2102H	See the fault type instruction	R
Identifying code of the VFD	2103H	GD300-----0x010a	R
Operation frequency	3000H	0–Fmax(unit: 0.01Hz)	R
Setting frequency	3001H	0–Fmax(unit: 0.01Hz)	R
Bus voltage	3002H	0.0–2000.0V (unit: 0.1V)	R
Output voltage	3003H	0–1200V (unit: 1V)	R
Output current	3004H	0.0–3000.0A (unit: 0.1A)	R
Rotation speed	3005H	0–65535 (unit: 1RPM)	R
Output power	3006H	-300.0–300.0% (unit: 0.1%)	R
Output torque	3007H	-250.0–250.0% (unit: 0.1%)	R
Close loop setting	3008H	-100.0–100.0% (unit: 0.1%)	R
Close loop feedback	3009H	-100.0–100.0% (unit: 0.1%)	R
Input IO state	300AH	000–1FF	R
Output IO state	300BH	000–1FF	R
Analog input 1	300CH	0.00–10.00V (unit: 0.01V)	R
Analog input 2	300DH	0.00–10.00V (unit: 0.01V)	R
Analog input 3	300EH	0.00–10.00V (unit: 0.01V)	R
Analog input 4	300FH		R
Read input of high-speed pulse 1	3010H	0.00–50.00kHz (unit: 0.01Hz)	R
Read input of high-speed pulse 2	3011H		R
Read the current stage of multi-step speed	3012H	0–15	R
External length	3013H	0–65535	R
External counting	3014H	0–65535	R

Function instruction	Address definition	Data meaning instruction	R/W characteristics
Torque setting	3015H	-300.0–300.0% (unit: 0.1%)	R
Identifying code of the VFD	3016H		R
Fault code	5000H		R

R/W characteristics means the function is with read and write characteristics. For example, "communication control command" is writing characteristics and control the VFD with writing command (06H). R characteristic can only read other than write and W characteristic can only write other than read.

Note: when operate on the VFD with the table above, it is necessary to enable some parameters. For example, the operation of running and stopping, it is necessary to set P00.01 to communication running command channel and set P00.02 to Modbus communication channel. And when operate on "PID given", it is necessary to set P09.00 to "Modbus communication setting".

The encoding rules for device codes (corresponds to identifying code 2103H of the VFD)

High 8 bit	Meaning	Low 8 bit	Meaning
01	GD	0x08	GD35 vector VFD
		0x09	GD35-H1 vector VFD
		0x0a	GD300 vector VFD
		0x0b	GD100 simple vector VFD
		0x0c	GD200 universal VFD
		0x0d	GD10 mini VFD

10.4.6 Fieldbus ratio values

The communication data is expressed by hex in actual application and there is no radix point in hex. For example, 50.12Hz cannot be expressed by hex so 50.12 can be magnified by 100 times into 5012, so hex 1394H can be used to express 50.12.

A non-integer can be timed by a multiple to get an integer and the integer can be called fieldbus ratio values.

The fieldbus ratio values are referred to the radix point of the setting range or default value in the function parameter list. If there are figures behind the radix point ($n=1$), then the fieldbus ratio value m is 10^n . Take the table as the example:

Function code	Name	Description	Setting range	Default value	Modify	Serial No.
P01.20	Hibernation restore delay time	0.0 - 3600.0s (valid when P01.19=2)	0.0 - 3600.0	0.0s	<input type="radio"/>	39.
P01.21	Restart after power off	0: Disable 1: Enable	0 - 1	0	<input type="radio"/>	40.

If there is one figure behind the radix point in the setting range or the default value, then the fieldbus ratio value is 10. if the data received by the upper monitor is 50, then the "hibernation restore delay time" is 5.0 (5.0=50 ÷ 10).

If Modbus communication is used to control the hibernation restore delay time as 5.0s. Firstly, 5.0 can be magnified by 10 times to integer 50 (32H) and then this data can be sent.

01 **06** **01 14** **00 32** **49 E7**
 VFD Read Parameters Data number CRC check
 address command address

After the VFD receives the command, it will change 50 into 5 according to the fieldbus ratio value and then set the hibernation restore delay time as 5s.

Another example, after the upper monitor sends the command of reading the parameter of hibernation restore delay time ,if the response message of the VFD is as following:

01 **03** **02** **00 32** **39 91**
 VFD Read 2-byte Parameters CRC check
 address command data data

Because the parameter data is 0032H (50) and 50 divided by 10 is 5, then the hibernation restore delay time is 5s.

10.4.7 Fault message response

There may be fault in the communication control. For example, some parameter can only be read. If a writing message is sent, the VFD will return a fault response message.

The fault message is from the VFD to the master, its code and meaning is as below:

Code	Name	Meaning
01H	Illegal command	The command from master cannot be executed. The reason maybe: 1. This command is only for new device; 2. Slave is in fault state and cannot execute it.
02H	Illegal data address.	Some of the operation addresses are invalid or not allowed to access. Especially the combination of the register and the

Code	Name	Meaning
		transmitting bytes are invalid.
03H	Illegal value	When there are invalid data in the message framed received by slave. Note: This error code does not indicate the data value to write exceed the range, but indicate the message frame is an illegal frame.
04H	Operation failed	The parameter setting in parameter writing is invalid. For example, the function input terminal cannot be set repeatedly.
05H	Password error	The password written to the password check address is not same as the password set by P7.00.
06H	Data frame error	In the frame message sent by the upper monitor, the length of the digital frame is incorrect or the counting of CRC check bit in RTU is different from the lower monitor.
07H	Parameters only for read	It only happen in write command
08H	Parameters cannot be changed during running	The modified parameter in the writing of the upper monitor cannot be modified during running.
09H	Password protection	When the upper monitor is writing or reading and the user password is set without password unlocking, it will report that the system is locked.

The slave uses functional code fields and fault addresses to indicate it is a normal response or some error occurs (named as objection response). For normal responses, the slave shows corresponding function codes, digital address or sub-function codes as the response. For objection responses, the slave returns a code which equals the normal code, but the first byte is logic 1.

For example: when the master sends a message to the slave, requiring it to read a group of address data of the VFD function codes, there will be following function codes:

0 0 0 0 0 1 1 (Hex 03H)

For normal responses, the slave responds the same codes, while for objection responses, it will return:

1 0 0 0 0 1 1 (Hex 83H)

Besides the function codes modification for the objection fault, the slave will respond a byte of abnormal code which defines the error reason.

When the master receives the response for the objection, in a typical processing, it will send the message again or modify the corresponding order.

For example, set the "running command channel" of the VFD (P00.01, parameter address is 0001H) with the address of 01H to 03, the command is as following:

<u>01</u>	<u>06</u>	<u>00 01</u>	<u>00 03</u>	<u>98 0B</u>
VFD address	Read command	Parameters address	Parameters data	CRC check

But the setting range of "running command channel" is 0–2, if it is set to 3, because the number is beyond the range, the VFD will return fault response message as below:

<u>01</u>	<u>86</u>	<u>04</u>	<u>43 A3</u>
VFD address	Abnormal response code	Fault code	CRC check

Abnormal response code 86H means the abnormal response to writing command 06H; the fault code is 04H. In the table above, its name is operation failed and its meaning is that the parameter setting in parameter writing is invalid. For example, the function input terminal cannot be set repeatedly.

10.4.8 Example of writing and reading

Refer to 10.4.1 and 10.4.2 for the command format.

10.4.8.1 Example of reading command 03H

Read the state word 1 of the VFD with the address of 01H (refer to table 1). From the table 1, the parameter address of the state word 1 of the VFD is 2100H.

The command sent to the VFD:

<u>01</u>	<u>03</u>	<u>21 00</u>	<u>00 01</u>	<u>8E 36</u>
VFD address	Read command	Parameters address	Data number	CRC check

If the response message is as below:

<u>01</u>	<u>03</u>	<u>02</u>	<u>00 03</u>	<u>F8 45</u>
VFD address	Read command	Data number	Data content	CRC check

The data content is 0003H. From the table 1, the VFD stops.

Watch "the current fault type" to "the previous 5 times fault type" of the VFD through commands, the corresponding function code is P07.27–P07.32 and corresponding parameter address is 071BH–0720H(there are 6 from 071BH).

The command sent to the VFD:

<u>03</u>	<u>03</u>	<u>07 1B</u>	<u>00 06</u>	<u>B5 59</u>
VFD address	Read command	Start address	6 parameters in total	CRC check

If the response message is as below:

03 03 0C 00 23 00 23 00 23 00 23 00 23 00 23 00 23 5F D2
VFD Read Byte Type of Type of Type of Type of Type of Type of CRC check
address command number current fault last fault but one fault but two fault but three fault but four fault

See from the returned data, all fault types are 0023H (decimal 35) with the meaning of maladjustment (STo).

10.4.8.2 Example of writing command 06H

Make the VFD with the address of 03H to run forward. See table 1, the address of "communication control command" is 2000H and forward running is 0001. See the table below.

Function description	Address definition	Data meaning description	R/W characteristics
Communication control command	2000H	0001H: forward running	W
		0002H: reverse running	
		0003H: forward jogging	
		0004H: reverse jogging	
		0005H: stop	
		0006H: coast to stop (emergency stop)	
		0007H: fault reset	
		0008H: jogging stop	
		0009H: pre-exciting	

The command sent by the master:

03 06 20 00 00 01 42 28
VFD Write Parameters Forward CRC
address command address running check

If the operation is success, the response may be as below (the same with the command sent by the master):

03 06 20 00 00 01 42 28
VFD Write Parameters Forward CRC
address command address running check

Set the Max. output frequency of the VFD with the address of 03H as100Hz.

Function code	Name	Detailed instruction of parameters	Setting range	Default value	Modify
P00.03	Max. output frequency	P00.04~600.00H (400.00Hz)	100.00~600.00	50.00Hz	☉

See the figures behind the radix point, the fieldbus ratio value of the Max. output frequency (P00.03) is 100. 100Hz timed by 100 is 10000 and the corresponding hex is 2710H.

The command sent by the master:

03 **06** **00 03** **27 10** **62 14**
 VFD Write Parameters Forward running CRC check
 address command address

If the operation is successful, the response may be as below (the same with the command sent by the master):

03 **06** **00 03** **27 10** **62 14**
 VFD Write Parameters Forward running CRC check
 address command address

Note: the blank in the above command is for illustration. The blank cannot be added in the actual application unless the upper monitor can remove the blank by themselves.

10.4.8.3 Example of continuous writing command 10H

Example 1: make the VFD whose address is 01H run forward at 10Hz. Refer to the instruction of 2000H and 0001. Set the address of "communication setting frequency" is 2001H and 10Hz corresponds to 03E8H. See the table below.

Function instruction	Address definition	Data meaning instruction	R/W characteristics
Communication control command	2000H	0001H:forward running	R/W
		0002H:reverse running	
		0003H:forward jogging	
		0004H:reverse jogging	
		0005H:stop	
		0006H:coast to stop (emergency stop)	
		0007H:fault reset	
		0008H:jogging stop	
The address of communication setting	2001H	Communication setting frequency(0–Fmax(unit: 0.01Hz))	R/W
	2002H	PID given, range (0–1000, 1000 corresponds to100.0%)	

Set P00.01 to 2 and P00.06 to 8.

The command sent to the VFD:

01 **10** **20 00** **00 02** **04** **00 01** **03 E8** **3B 10**
 VFD Continuous Parameters Data Byte Forward 10Hz CRC check
 address writing address number number running

If the response message is as below:

01 **10** **20 00** **00 02** **4A 08**
 VFD Continuous Parameters Data CRC check
 address writing address number

Example 2: set the ACC time of 01H VFD as 10s and the DEC time as 20s.

P00.11	ACC time 1	ACC time means the time needed if the VFD speeds up from 0Hz to the Max. One (P00.03).	Depend on model	<input type="radio"/>
P00.12	DEC time 1	DEC time means the time needed if the VFD speeds down from the Max. Output frequency to 0Hz (P00.03). Goodrive300 series VFDs define four groups of ACC/DEC time which can be selected by P05. The factory default ACC/DEC time of the VFD is the first group. Setting range of P00.11 and P00.12:0.0–3600.0s	Depend on model	<input type="radio"/>

The corresponding address of P00.11 is 000B, the ACC time of 10s corresponds to 0064H, and the DEC time of 20s corresponds to 00C8H.

The command sent to the VFD:

01 **10** **00 0B** **00 02** **04** **00 64** **00 C8** **F2 55**
 VFD Continuous Parameters Data Byte 10s 20s CRC check
 address writing address number number

If the response message is as below:

01 **10** **00 0B** **00 02** **30 0A**
 VFD Continuous Parameters Data CRC check
 address writing address number

Note: The space between above commands is for instruction and there is no space between the commands during actual applications.

10.4.8.4 Modbus communication debugging instance

A PC is used as the host, an RS232-RS485 converter is used for signal conversion, and the PC serial port used by the converter is COM1 (a RS232 port). The upper computer commissioning software is the serial port commissioning assistant Commix, which can be downloaded from the Internet. Download a version that can automatically execute the CRC check function. The following figure shows the interface of Commix.



First, select COM1 for "serial port" and the baud rate should be set to the same value with P14.01. The data bit, check bit and stop bit must be consistent with the setup in P14.02. As RTU mode is used here, "HEX" should be selected. Check ModbusRTU to make the software add CRC automatically, and select CRC16 (ModbusRTU) with the starting byte being 1. Once enabled, CRC check will be added automatically, which removes the need to fill in CRC manually.

The commissioning command to set the VFD whose address is 03H to be forward running is as follows:

<u>03</u>	<u>06</u>	<u>20 00</u>	<u>00 01</u>	<u>42 28</u>
VFD address	Write command	Parameter address	Forward running	CRC check

Note:

1. Set the address (P14.00) of the VFD to 03.
2. Set "Channel of running commands" (P00.01) to "Communication", and set "Communication channel of running commands" (P00.02) to the Modbus communication channel.
3. Click **Send**. If the line configuration and settings are correct, a response transmitted by the VFD will be received.

10.5 Common communication fault

Common communication faults: no response to the communication or the VFD returns abnormal fault.

The possible reason for no response to the communication:

- Selecting wrong serial interface, for example, if the converter is COM1, selecting COM2 during the communication
- The baud rate, digital bit, end bit and check bit are not the same with that of the VFD.
- + and - of RS485 bus are connected in reverse.
- The 485 wire cap on the terminal board of the VFD is not plug in the wire cap in behind the terminal arrangement.

Appendix A Extension card

A.1 What this chapter contains

This chapter describes the extension cards used in Goodrive300 series VFDs.

A.2 PROFIBUS extension card

(1) PROFIBUS is an open international fieldbus standard that allows data exchange among various types of automation components. It is widely used in manufacturing automation, process automation and in other automation areas such as buildings, transportation, power, providing an effective solution for the realization of comprehensive automation and site-equipment intellectualization.

(2) PROFIBUS is composed of three compatible components, PROFIBUS -DP (Decentralized Periphery, distributed peripherals), PROFIBUS-PA (Process Automation), PROFIBUS-FMS (Fieldbus Message Specification). It is periodically exchange data with the VFD when using master-slave way. PRNV PROFIBUS-DP Adapter module only supports PROFIBUS-DP protocol.

(3) The physical transmission medium of bus is twisted-pair (in line with RS-485 standard), two-wire cable or fiber optic cable. Baud rate is from 9.6Kbit/s to 12Mbit/s. The maximum bus cable length is between 100 m and 1200 m, specific length depending on the selected transmission rate (see Appendix B "Technical data"). Up to 31 nodes can be connected to the same PROFIBUS network when repeaters aren't used. But, if use repeaters, up to 127 nodes can be connected to the same PROFIBUS network segment (including repeaters and master stations).

(4) In the process of PROFIBUS communication, tokens are assigned among main stations and master-slave transmission among master-slave stations. Supporting single-master or multi-master system, stations-programmable logic controller (PLC)-choose nodes to respond to the host instruction. Cycle master-from user data transmission and non-cyclic master-master station can also send commands to multiple nodes in the form of broadcast. In this case, the nodes do not need to send feedback signals to the host. In the PROFIBUS network, communication between nodes cannot be allowed.

(5) PROFIBUS protocol is described in detail in EN 50170 standard. To obtain more information about PROFIBUS, please refer to the above-mentioned EN 50170 standards.

A.2.1 Product naming rules

Fieldbus adapter naming rules, the product model:

EC-TX 1 03

① ② ③ ④

No.	Instruction	Meaning
①	Product type	EC: extension card
②	Card type	TX: communciation card
③	Technical	Odds such as 1,3,5,7 means the 1 st , 2 nd , 3 rd , 4 th technical version
④	Card difference	03: PROFIBUS+Ethernet communication card 04: Ethernet+CAN communication card

A.2.2 EC-TX-103 communication card

EC-TX-103 communication card is an optional device to VFD which makes VFD connected to PROFIBUS network. In PROFIBUS network, VFD is a subsidiary device. The following functions can be completed using EC-TX-103 communication card:

- Send control commands to VFD (start, stop, fault reset, etc.).
- Send speed or given torque signal to VFD.
- Read state and actual values from VFD.
- Modify VFD parameter.

Please refer to the description of function codes in Group P15 for the commands supported by the VFD. Below is the structure diagram of the connection between the VFD and PROFIBUS bus:

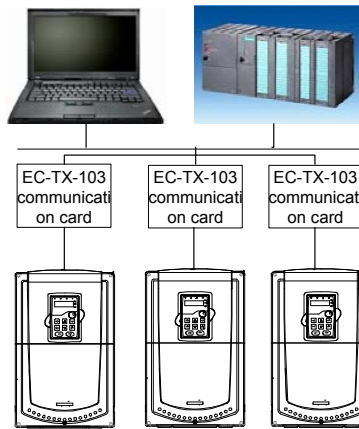

A.2.3 The appearance of EC-TX-103 communication card

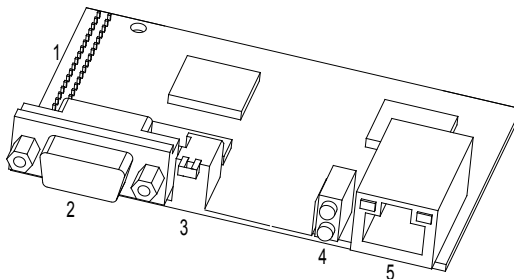

Outline diagram of EC-TX-103 communication card

1. Interface to the panel
2. Bus connector
3. Rotation node address selection switches
4. State display LEDs
5. Ethernet communication interface

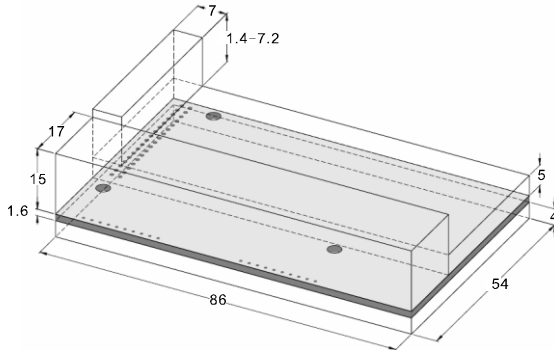

External dimensions of EC-TX-103 communication card (Unit: mm)

A.2.4 Compatible motor of EC-TX-103 communication card

EC-TX-103 communication card is compatible with the following products:

- Goodrive300 series devices and all blasters supporting PROFIBUS/CANOPEN extension
- Host station supporting PROFIBUS/CANOPEN-DP protocol

A.2.5 Delivery list

The package of EC-TX-103 communication card contains:

- EC-TX-103 communication card
- Three copper columns (M3x10)
- User's manual

Please contact with the company or suppliers if there is something missing. Notice will not be given for the reason of product upgrades.

A.2.6 Installation of EC-TX-103 communication card

A.2.6.1 Mechanical installation of EC-TX-103 communication card

1. Installation ambient

- Ambient temperature: 0°C – +40°C
- Relative humidity: 5%–95%
- Other climate conditions: no dew, ice, rain, snow, hail air condition and the solar radiation is below 700W/m², air pressure 70–106kPa
- Content of salt spray and corrosive gases : Pollution degree 2
- Dust and solid particles content: Pollution degree 2
- Vibration and shock: 5.9m/s² (0.6g) on 9–200Hz sinusoidal vibration

2. Installation steps:

- Fix the three copper columns on the location holes with screws.

- Insert the module into the defined location carefully and fix it on the copper column with screw.
- Set the bus terminal switch of the module to the needed location.

3. Notes:

Disconnect the device from the power line before installation. Wait for at least three minutes to let the capacitors discharge. Cut off dangerous voltage from external control circuit to the unit output and input terminals.

Some electric components are sensitive to static charge. Do not touch the circuit board. If you have to operate on it, please wear the grounding wrist belt.

A.2.6.2 Electrical installation of EC-TX-103 communication card

1. Node selection

Node address is the only address of PROFIBUS on the bus. The address which is among 00–99 is shown with two figures and is selected by the spinning switch on the module. The left switch shows the first number and the right one show the second number.

Node address = 10 x the first digital value + the second digital value x 1

2. Bus terminals

There is a bus terminal in each heading and ending to avoid error during operation. The DIP switch on RPBA-01PCB is used to connect the bus terminals which can avoid the signal feedback from the bus cables. If the module is the first or last one in the internet, the bus terminal should be set as ON. Please disconnect EC-TX-103 communication card terminals when the PROFIBUS D-sub connector with internal terminals is in use.

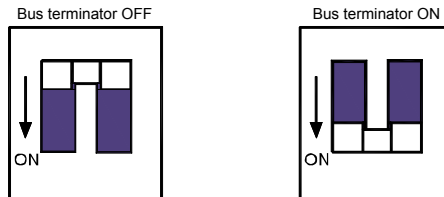

A.2.6.3 Bus net connection of EC-TX-103 communication card

1. Bus communication interface

Transformation by double-shielded twisted pair copper cable is the most common way in PROFIBUS (conform to RS-485standard).

The basic characteristics of transformation technology:

- Net topology: Linear bus, there are bus resistor in two ends.
- Transforming speed: 9.6k bit/s–12M bit/s
- Medium: double-shielded twisted pair cables,the shield can be removed according to the environment (EMC).

- Station number: There are 32 stations in each segment (without relays) as to 127 stations (with relays)
- Contact pin: 9 frames D pin, the connector contact pins are as below:

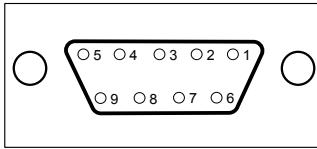

Contact pin of the connector		Instruction
1	-	Unused
2	-	Unused
3	B-Line	Positive data(twisted pair cables 1)
4	RTS	Sending requirement
5	GND_BUS	Isolation ground
6	+5V BUS	Isolated 5V DC power supply
7	-	Unused
8	A-Line	Negative data(twisted pair cables 2)
9	-	Unused
Housing	SHLD	PROFIBUS shielded cable

+5V and GND_BUS are used in the fieldbus terminals. Some devices, such as light transceiver (RS485) may get external power supply form these pins.

RTS is used in some devices to determine the sending direction. Only A-Line wires, B-Line wires and shield are used in the normal application.

It is recommended to apply the standard DB9 connector of SIEMENS. If the communication baud rate is above 187.5kbps, please follow the connection rules of SIEMENS seriously.



Available

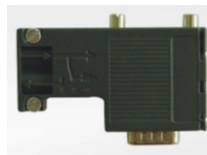

Not available (with interference to the keypad wiring)

2. Repeater

Up to 32 stations can be connected to each segment (master station or subsidiary stations), the repeater have to be used when stations is more than 32. The repeaters in series are generally no more than 3.

Note: There is no repeater station address.

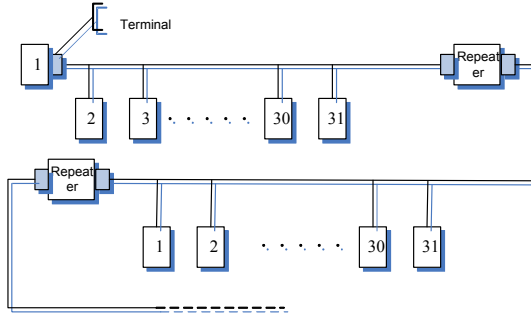

A.2.6.4 Transmission rate and maximum distance

Maximum length of cable depends on the transmission rate. The Table below shows the relationship between transmission rate and distance.

Transmission rate (kbps)	A-wire (m)	B-wire (m)
9.6	1200	1200
19.2	1200	1200
93.75	1200	1200
187.5	1000	600
500	400	200
1500	200	-----
12000	100	-----

Transmission line parameters:

Transmission rate (kbps)	A-wire (m)	B-wire (m)
Impedance (Ω)	135–165	100–130
Capacitance per unit length(pF/m)	< 30	< 60
Loop Resistance (Ω /km)	110	-----
Core wire diameter (mm)	0.64	> 0.53
Line-core cross-section (mm^2)	> 0.34	> 0.22

Besides shielding twisted-pair copper wires, PROFIBUS can also use optical fiber for transmission in an electromagnetic interference environment to increase the high-speed transmission distance there are two kinds of fiber optical conductors, one is low-cost plastic fiber conductor, used distance is less than 50 meters, the other is glass fiber conductor, and used distance is less than 1 KM.

A.2.6.5 PROFIBUS bus connection diagram

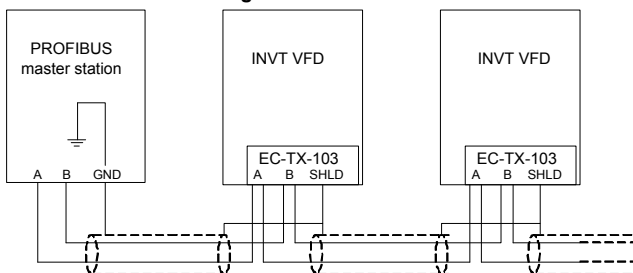

Above is "terminal" wiring diagram. Cable is a standard PROFIBUS cable consisting of a twisted pair and shielding layer. The shielded layer of PROFIBUS cable on all nodes is directly grounded. Users can choose the best grounding method according to the situation.

Note:

1. Make sure that signal lines do not twist when connecting all stations. Shielded cable should be used when system runs under high electromagnetic interface environment, which can improve electromagnetic compatibility (EMC).
2. If using shielded braided wire and shielding foil, both ends should be connected to ground. Using shielding area should be large enough to maintain a good conductivity. And data lines must be separated from high-voltage.
3. Stub line segment should not be used when transmission rate more than 500K bit/s, The plug is available on the market which connects directly to data input and output cable. Bus plug connection can be on or off at any time without interruption of data communications of other station.

A.2.7 System configuration

1. Master station and VFD should be configured so that the master station can communicate with the module after correctly installing EC-TX-103 communication card.

Each PROFIBUS subsidiary station on the PROFIBUS bus need to have "device description document" named GSD file which used to describe the characteristics of PROFIBUS -DP devices. The software we provided for the user includes VFD related GSD files (device data files) information, users can obtain type definition file (GSD) of master machines from local INVT agent.

Configuration parameters of EC-TX-103 communication card:

Parameter number	Parameter name	Optional setting	Factory setting
0	Module type	Read only	PROFIBUS-DP
1	Node address	0-99	2
2	Baud rate setting	kbit/s 0:9.6 1:19.2 2:45.45 3:93.75	6

Parameter number	Parameter name	Optional setting	Factory setting
		4:187.5	
		5:500	
		6:1.5	
		7:3	
		8:6	
		9:9	
		10:12	
3	PZD3	0-65535	0
4	PZD4	The same as the above	0
...	The same as the above	0
10	PZD12	The same as the above	0

2. Module type

This parameter shows communication module type detected by VFD; users cannot adjust this parameter. If this parameter is not defined, communication between the modules and VFD cannot be established.

3. Node address

In PROFIBUS network, each device corresponds to a unique node address, you can use the node address selection switch to define node address (switch isn't at 0) and the parameter is only used to display the node address.

If node address selection switch is 0, this parameter can define node address. The user cannot adjust the parameter by themselves and the parameter is only used to display the node address.

4. GSD file

In PROFIBUS network, each PROFIBUS subsidiary station needs GSD file "device description document" which used to describe the characteristics of PROFIBUS-DP devices. GSD file contains all defined parameters, including baud rate, information length, amount of input/output data, meaning of diagnostic data.

A CD-ROM will be offered in which contains GSD file (extension name is .gsd) for fieldbus adapter. Users can copy GSD file to relevant subdirectory of configuration tools, please refer to relevant system configuration software instructions to know specific operations and PROFIBUS system configuration.

A.2.8 PROFIBUS-DP communication

1. PROFIBUS-DP

PROFIBUS-DP is a distributed I/O system, which enables master machine to use a large number of peripheral modules and field devices. Data transmission shows cycle: master machine read input information from subsidiary machine then give feedback signal. EC-TX-103 communication card supports PROFIBUS-DP protocol.

2. Service access point

PROFIBUS-DP has access to PROFIBUS data link layer (Layer 2) services through service access point SAP. Every independent SAP has clearly defined function. Please refer to relevant PROFIBUS user manual to know more about service access point information. PROFIDRIVE-Variable speed drive adopts PROFIBUS model or EN50170 standards (PROFIBUS protocol).

3. PROFIBUS-DP information frame data structures

PROFIBUS-DP bus mode allows rapid data exchange between master station and VFD. Adopting master-slave mode dealing with VFD access, VFD is always subsidiary station, and each has definite address. PROFIBUS periodic transmission messages use 16 words (16 bit) transmission, the structure shown in figure1.

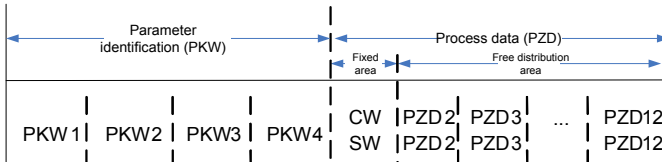

Parameters area:

PKW1-Parameter identification

PKW2-array index number

PKW3-parameter value 1

PKW4-parameter value 2

Process data:

CW-Control word (from master to slave)

SW-state word (from slave to master)

PZD-process data (decided by users)

(From master to slave output **【given value】** , from slave to master input **【actual value】**)

PZD area (process data area):

PZD area of communication message is designed for control and monitor VFD. PZD from master and slave station is addressed in high priority; the priority of dealing with PZD is superior to that of PKW, and always sends current valid date from interface.

Control word (CW) and state word (SW):

Control word (CW) is a basic method of fieldbus system controlling VFD. It is sent by the fieldbus master station to VFD and the EC-TX-103 communication cards act as gateway. VFD responds according to the control word and gives feedbacks to master machine through state word (SW).

Given value: VFD can receive control information by several ways, these channels include: analog and digital input terminals, VFD control board and module communication (such as RS485,

EC-TX-103 communication cards). In order to use PROFIBUS/CANOPEN control VFD, the communication module must be set to be VFD controller.

Actual value: Actual value is a 16-bit word, which contains converter operation information. Monitoring capabilities are defined by VFD parameter. The integer scaling of actual value is sent to master machine depending on selected function, please refer to VFD manual.

Note: VFD always check the control word (CW) and bytes of given value.

Mission message (From master station to VFD)

Control word (CW): The first word of PZD is control word (CW) of VFD. The definitions of CWs on the PWM rectifier regenerative part are different from those on the inverter part, and therefore two tables are used to describe the CWs.

Control word (CW) of Goodrive300 series

Bit	Name	Value	State/Description
0-7	COMMAND BYTE	1	Forward running
		2	Reverse running
		3	Forward jogging
		4	Reverse jogging
		5	Decelerate to stop
		6	Coast to stop (Emergency stop)
		7	Fault reset
		8	Jogging stop
8	WRITE ENABLE	1	Write enable (mainly is PKW1-PKW4)
9-10	MOTOR GROUP SELECTION	00	MOTOR GROUP 1 SELECTION
		01	MOTOR GROUP 2 SELECTION
		02	MOTOR GROUP 3 SELECTION
		03	MOTOR GROUP 4 SELECTION
11	TORQUE CONTROL SELECTION	1	Torque control enable
		0	Torque control disable
12	ELECTRIC CONSUMPTION CLEAR	1	Electric consumption clear enable
		0	Electric consumption clear disable
13	PRE-EXCIATION	1	Pre-exciation enable
		0	Pre-exciation disable
14	DC BRAKE	1	DC braking enable
		0	DC braking disable
15	HEARTBEAT REF	1	Heartbeat enable
		0	Heartbeat disable

Reference value (REF): From 2nd word to 12th of PZD task message is the main set value REF, main frequency set value is offered by main setting signal source. As PWM rectifier feedback part doesn't have main frequency setting part, corresponding settings belong to reserved part, the following table describes inverter part settings for Goodrive300.

Bit	Name	Function selection
PZD2 receiving	0: Invalid	0
PZD3 receiving	1: Set frequency(0–Fmax(unit:0.01Hz))	0
PZD4 receiving	2: Given PID, range (0–1000,1000 corresponds to 100.0%)	0
PZD5 receiving	3: PID feedback, range (0–1000,1000 corresponds to 100.0%)	0
PZD6 receiving	4: Torque set value (-3000–3000,1000 corresponds to 100.0% the rated current of the motor)	0
PZD7 receiving	5: Set value of the forward rotation upper-limit frequency (0–Fmax unit:0.01Hz)	0
PZD8 receiving	6: Set value of the reversed rotation upper-limit frequency (0–Fmax(unit:0.01Hz))	0
PZD9 receiving	7: Electromotion torque upper limit (0–3000,1000 corresponds to 100.0%of the rated current of the motor)	0
PZD10 receiving	8: Braking torque upper limit (0–2000,1000 corresponds to 100.0% of the rated current of the motor)	
PZD11 receiving	9: Virtual input terminals command, range:0x000–0x1FF	
PZD12 receiving	10: Virtual output terminals command, range:0x00–0x0F	
	11: Voltage setting value (special for V/F separation) (0–1000,1000 corresponds to 100.0% the rated voltage of the motor)	
	12: AO output set value 1 (-1000–1000, 1000 corresponds to 100.0%)	
	13: AO output set value 2 (-1000–1000, 1000 corresponds to 100.0%)	

Response message (from the VFD to the master station)

State word (SW): The first word of PZD response message is state word (SW) of VFD, the definition of state word is as follows:

State word (SW) of Goodrive300 series

Bit	Name	Value	State/Description
0–7	RUN STATE BYTE	1	Forward running
		2	Reverse running

Bit	Name	Value	State/Description
		3	The VFD stops
		4	The VFD is in fault
		5	The VFD is in POFF state
		6	Pre-exciting state
8	DC VOLTAGE ESTABLISH	1	Running ready
		0	The running preparation is not ready
9-10	MOTOR GROUP FEEDBACK	0	Motor 1 feedback
		1	Motor 2 feedback
		2	Motor 3 feedback
		3	Motor 4 no feedback
11	MOTOR TYPE FEEDBACK	1	Synchronous motor
		0	Asynchronous motor
12	OVERLOAD ALARM	1	Overload pre-alarm
		0	Non-overload pre-alarm
13	RUN/STOP MODE	0	Keypad control
		1	Terminal control
14		2	Communication control
		3	Reserved
15	HEARTBEAT FEEDBACK	1	Heartbeat feedback
		0	No heartbeat feedback

Actual value (ACT): From 2nd word to 12th of PZD task message is main set value ACT, main frequency set value is offered by main setting signal source.

Actual state value of Goodrive300 series

Bit	Name	Function selection
PZD2 sending	0: Invalid	0
	1: Running frequency(×100, Hz)	
PZD3 sending	2: Set frequency(×100, Hz)	0
	3: Bus voltage (×10, V)	
PZD4 sending	4: Output voltage (×1, V)	0
	5: Output current (×10, A)	
PZD5 sending	6: Output torque actual value (×10, %)	0
	7: Output power actual value (×10, %)	
PZD6 sending	8: Running rotating speed(×1, RPM)	0
	9: Running linear speed (×1, m/s)	
	10: Ramp frequency reference	

Bit	Name	Function selection
PZD7 sending	11: Fault code 12: AI1 value (×100, V)	0
PZD8 sending	13: AI2 value (×100, V) 14: AI3 value (×100, V)	0
PZD9 sending	15: PULSE frequency value (×100, kHz)	0
PZD10 sending	16: Terminals input state 17: Terminals output state	0
PZD11 sending	18: PID given (×100, %) 19: PID feedback (×100, %)	0
PZD12 sending	20: Motor rated torque 21: Control word	0

PKW area (parameter identification marks PKW1-value area). PKW area describes treatment of parameter identification interface, PKW interface is a mechanism which determine parameters transmission between two communication partners, such as reading and writing parameter values.

Structure of PKW area

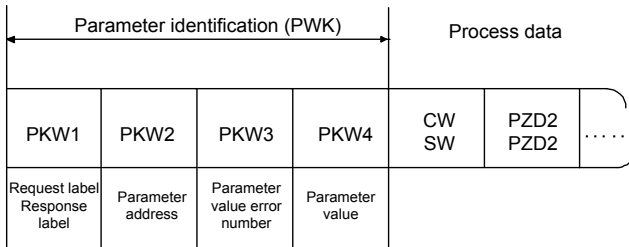

Parameter identification zone

In the process of periodic PROFIBUS-DP communication, PKW area is composed of four words (16 bit), each word is defined as follows:

The first word PKW1 (16 bit)		
Bit 15–00	Task or response identification marks	0–7
The second word PKW2 (16 bit)		
Bit 15–00	Basic parameters address	0–247
The third word PKW3 (16 bit)		
Bit 15–00	Parameter value (high word) or return error code value	00
The fourth word PKW4 (16 bit)		
Bit 15–00	Parameter value (low word)	0–65535

Note: If the master requests one parameter value, the value of PKW3 and PKW4 will not be valid.

Task requests and responses: When passing data to slave machine, master machine use request label while slave machine use response label to positive or negative confirmation. Table 5.5 and Table 5.6 list the request/response functional.

The definition of task logo PKW1 is as follows:

Request label (From master to slave)		Response label	
Request	Function	Positive confirmation	Negative confirmation
0	No task	0	—
1	Request parameter value	1,2	3
2	Modification parameter value (one word) [only change RAM]	1	3 or 4
3	Modification parameter value (double word) [only change RAM]	2	3 or 4
4	Modification parameter value (one word) [RAM and EEPROM are modified]	1	3 or 4
5	Modification parameter value (double word) [RAM and EEPROM are modified]	2	3 or 4

Request label "2"-modification parameter value (one word) [only change RAM], "3"-modification parameter value (double word) [only change RAM], "5"-modification parameter value (double word) [RAM and EPROM are modified] not support currently.

Reponses logo PKW1 defines as below:

Response label (From slave to master)	
Confirmation	Function
0	No response
1	Transmission parameter value (one word)
2	Transmission parameter value (two word)
3	Task cannot be executed and returns the following error number: 0: Illegal parameter number 1: Parameter values cannot be changed (read-only parameter) 2: Out of set value range 3: The sub-index number is not correct 4: Setting is not allowed (only reset) 5: Data type is invalid 6: The task could not be implemented due to operational state 7: Request isn't supported. 8: Request can't be completed due to communication error 9: Fault occurs when write operation to stationary store

Response label (From slave to master)	
Confirmation	Function
	10: Request fails due to timeout 11: Parameter cannot be assigned to PZD 12: Control word bit can't be allocated 13: Other errors
4	No parameter change rights

PKW examples:

Example 1: Read parameter value. Read keypad set frequency value (the address of keypad set frequency is 10) which can be achieved by setting PKW1 as 1, PKW2 as 10, return value is in PKW4.

Request (From master to VFD):

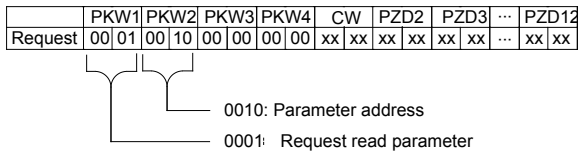

Response (From VFD to master)

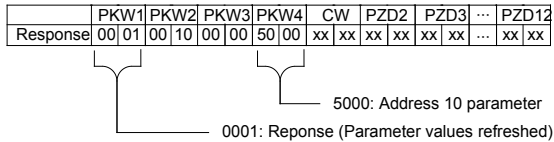

Example 2: Modify the parameter values (RAM and EEPROM are modified). Modify keypad settings frequency value (the address of keypad set frequency is 10) which can be achieved by setting PKW1 as 4; PKW2 as 10, modification value (50.00) is in PKW4.

Request (From master to VFD):

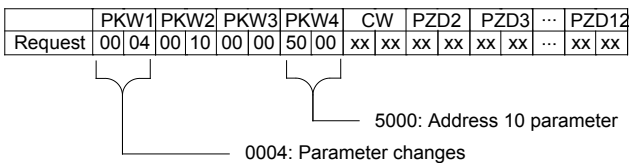

Response (From VFD to master)

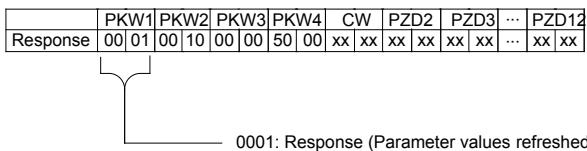

Example for PZD:

Transmission of PZD area is achieved through VFD function code; please refer to relevant INVT VFD user manual to know relevant function code.

Example 1: Read process data of VFD

VFD parameter selects "8: Running rotation speed" as PZD3 to transmit which can be achieved by setting P15.14 as 8. This operation is mandatory until the parameter is instead of others.

Request (From master to VFD):

	PKW1		PKW2		PKW3		PKW4		CW		PZD2		PZD3		...	PZD12	
Response	xx	xx	xx	xx	xx	xx	xx	xx	xx	xx	xx	xx	00	0A	...	xx	xx

Example 2: Write process data into VFD

VFD parameter selects "2: PID reference" from PZD3 which can be achieved by setting P15.03 as 2. In each request frame, parameters will use PZD3 to update until re-select a parameter.

Request (From master to converter):

	PKW1		PKW2		PKW3		PKW4		CW		PZD2		PZD3		...	PZD12	
Response	xx	xx	xx	xx	xx	xx	xx	xx	xx	xx	xx	xx	00	00	...	xx	xx

In each request frame contents of PZD3 are given by traction until re-select a parameter.

A.2.9 Fault information

EC-TX-103 communication card is equipped with 2 fault display LEDs as shown is figure below. The roles of these LEDs are as follows:

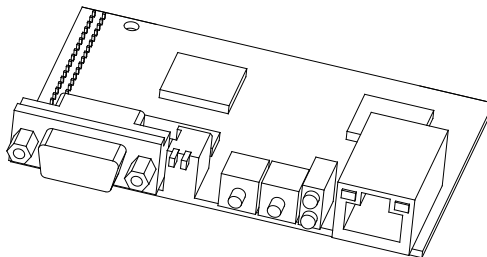

Fault display LEDs

LED No.	Name	Color	Function
2	Online	Green	ON-module online and data can be exchanged. OFF-module is not in "online" state.
4	Offline/Fault	Red	ON-module offline and data can't be exchanged. OFF-module is not in "offline" state. 1. Flicker frequency 1Hz-configuration error: The length of user parameter data sets is different from that of network configuration process during module initialization

LED No.	Name	Color	Function
			process. 2. Flicker frequency 2Hz-user parameter data error: The length or content of user parameter data sets is different from that of network configuration process during module initialization process. 3. Flicker frequency 4Hz-PROFIBUS communication ASIC initialization error. 4. OFF-Diagnostic closed.

A.3 CANopen optional cards

Refer to the operation manual of EC-TX105 CANopen communication cards.

Appendix B Technical data

B.1 What this chapter contains

This chapter contains the technical specifications of the VFD, as well as provisions for fulfilling the requirements for CE and other marks.

B.2 Ratings

B.2.1 Capacity

VFD sizing is based on the rated motor current and power. To achieve the rated motor power given in the table, the rated current of the VFD must be higher than or equal to the rated motor current. Also the rated power of the VFD must be higher than or equal to the rated motor power. The power ratings are the same regardless of the supply voltage within one voltage range.

Note:

1. The maximum allowed motor shaft power is limited to $1.5 \cdot PN$. If the limit is exceeded, motor torque and current are automatically restricted. The function protects the input bridge of the drive against overload.
2. The ratings apply at ambient temperature of 40 °C
3. It is important to check that in Common DC systems the power flowing through the common DC connection does not exceed PN .

B.2.2 Derating

The load capacity decreases if the installation site ambient temperature exceeds 40 °C, the altitude exceeds 1000 meters or the switching frequency is changed from 4 kHz to 8, 12 or 15 kHz.

B.2.2.1 Temperature derating

In the temperature range +40 °C...+50 °C, the rated output current is decreased by 1% for every additional 1 °C. Refer to the below list for the actual derating.

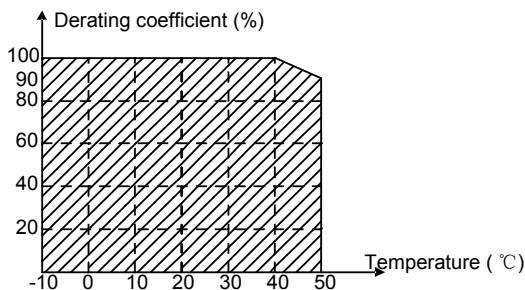

Note: It is not recommended to use the VFD at above 50°C, otherwise, the consequences arising from thereform shall be undertaken by the clients.

B.2.2.2 Altitude derating

When the installation site altitude is lower than 1000 m, the VFD can run at the rated power. If the

altitude on the site is higher than 1000 m, and not more than 3000 m, the maximum power is derated by 1% for every increased 100 m. For details about the derating, see the following figure.

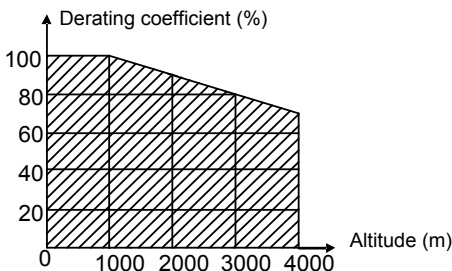

When the altitude exceeds 2000m, configure an isolation transformer on the input end of the VFD.

When the altitude exceeds 3000m but is lower than 5000m, contact us for technical consultation. Do not use the VFD at an altitude higher than 5000m.

B.2.2.3 Carrier frequency derating

For Goodrive300 series VFDs, different power level corresponds to different carrier frequency range. The rated power of the VFD is based on the factory carrier frequency, so if it is above the factory value, the VFD needs to derate 10% for every additional 1 kHz carrier frequency.

B.3 Grid specifications

Grid voltage	AC 3PH 380V(-15%)–440V(+10%) AC 3PH 380V(-10%)–550V(+10%) AC 3PH 520V(-15%)–690V(+10%)
Short-circuit capacity	Maximum allowed prospective short-circuit current at the input power connection as defined in IEC 60439-1 is 100 kA. The drive is suitable for use in a circuit capable of delivering not more than 100 kA at the drive maximum rated voltage.
Frequency	50/60 Hz ± 5%, maximum rate of change 20%/s

B.4 Motor connection data

Motor type	Asynchronous induction motor or synchronous permanent magnet motor
Voltage	0 to U1, 3-phase symmetrical, Umax at the field weakening point
Short-circuit protection	The motor output is short-circuit proof by IEC 61800-5-1
Frequency	0...400 Hz
Frequency resolution	0.01 Hz
Current	Refer to section 3.6 "Rated specifications"
Power limit	1.5 · PN

Field weakening point	10...400 Hz
Carrier frequency	4, 8, 12 or 15 kHz(in scalar control)

B.4.1 EMC compatibility and motor cable length

The following table describes the maximum motor cable lengths that meet the requirements of the EU EMC directive (2004/108/EC) when the carrier frequency is 4 kHz.

All models (with external EMC filters)	Maximum motor cable length (m)
Environment category II (C3)	30
Environment category I (C2)	30

You can learn the maximum length of the motor cable through the running parameters of the VFD. To understand the accurate maximum cable length for using an external EMC filter, contact the local INVT office.

For description about the environments categories I (C2) and II (C3), see section B.6 "EMC regulations".

B.5 Applicable standards

The VFD complies with the following standards:

EN ISO 13849-1: 2008	Safety of machinery—Safety-related parts of control systems—Part 1: General principles for design
IEC/EN 60204-1: 2006	Safety of machinery—Electrical equipment of machines. Part 1: General requirements
IEC/EN 62061: 2005	Safety of machinery—Safety-related functional safety of electrical, electronic, and programmable electronic control systems
IEC/EN 61800-3: 2004	Adjustable speed electrical power drive systems—Part 3: EMC requirements and specific test methods
IEC/EN 61800-5-1: 2007	Adjustable speed electrical power drive systems—Part 5-1: Safety requirements—Electrical, thermal and energy
IEC/EN 61800-5-2: 2007	Adjustable speed electrical power drive systems—Part 5-2: Safety requirements—Function
GB/T 30844.1-2014	General-purpose variable-frequency adjustable-speed equipment of 1 kV and lower—Part 1: Technical conditions
GB/T 30844.2-2014	General-purpose variable-frequency adjustable-speed equipment of 1 kV and lower—Part 2: Test methods
GB/T 30844.3-2014	General-purpose variable-frequency adjustable-speed equipment of 1 kV and lower—Part 3: Safety regulations

B.5.1 CE marking

The CE marking on the nameplate of a VFD indicates that the VFD is CE-compliant, meeting the regulations of the European low-voltage directive (2006/95/EC) and EMC directive (2004/108/EC).

B.5.2 Compliance with the European EMC Directive

European union (EU) stipulates that the electric and electrical devices sold in Europe cannot generate electromagnetic disturbance that exceeds the limits stipulated in related standards, and can work properly in environments with certain electromagnetic interference. The EMC product standard (EN 61800-3:2004) describes the EMC standards and specific test methods for adjustable speed electrical power drive systems. Products must strictly follow these EMC regulations.

B.6 EMC regulations

The EMC product standard (EN 61800-3:2004) describes the EMC requirements on VFDs.

Application environment categories

Category I: Civilian environments, including application scenarios where VFDs are directly connected to the civil power supply low-voltage grids without intermediate transformers

Category II: All environments except those in Category I.

VFD categories

C1: Rated voltage lower than 1000 V, applied to environments of Category I.

C2: Rated voltage lower than 1000 V, non-plug, socket, or mobile devices; power drive systems that must be installed and operated by specialized personnel when applied to environments of Category I

Note: The EMC standard IEC/EN 61800-3 no longer restricts the power distribution of VFDs, but it specifies their use, installation, and commissioning. Specialized personnel or organizations must have the necessary skills (including the EMC-related knowledge) for installing and/or performing commissioning on the electrical drive systems.

C3: Rated voltage lower than 1000 V, applied to environments of Category II. They cannot be applied to environments of Category I.

C4: Rated voltage higher than 1000 V, or rated current higher or equal to 400 A, applied to complex systems in environments of Category II.

B.6.1 Category C2

The induction disturbance limit meets the following stipulations:

1. Select an optional EMC filter according to Appendix D "Peripheral options and parts", and install it following the description in the EMC filter manual.
2. Select the motor and control cables according to the description in the manual.
3. Install the VFD according to the description in the manual.
4. For the maximum length of the motor cable when the switching frequency is 4 kHz, see section B.4.1 "EMC compatibility and motor cable length".



- Currently in environments in China, the VFD may generate radio interference, you need to take measures to reduce the interference.

B.6.2 Category C3

The anti-interference performance of the VFD meets the requirements of environments Category II in the IEC/EN 61800-3 standard.

The induction disturbance limit meets the following stipulations:

1. Select an optional EMC filter according to Appendix D "Peripheral options and parts", and install it following the description in the EMC filter manual.
2. Select the motor and control cables according to the description in the manual.
3. Install the VFD according to the description in the manual.
4. For the maximum length of the motor cable when the switching frequency is 4 kHz, see section B.4.1 "EMC compatibility and motor cable length".



- VFDs of C3 category cannot be applied to civilian low-voltage common grids. When applied to such grids, the VFD may generate radio frequency electromagnetic interference.

Appendix C Dimension drawings

C.1 What this chapter contains

Dimension drawings of the Goodrive300 are shown below. The dimensions are given in millimeters and inches.

C.2 Keypad structure

C.2.1 Structure chart

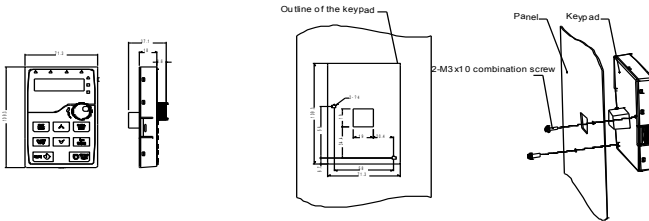

Hole-cutting size and diagram for non-bracket keypad installation

C.2.2 Installaiton with bracket (optional)

Note: It is necessary to use M3 screw or installation bracket to fix the external keypad. The installation bracket for VFDs of 380V 1.5–30kW and 500V 4–18.5kW is optional but it is standard for the VFDs of 380V 37–500kW, 500V 22–500kW and 660V.

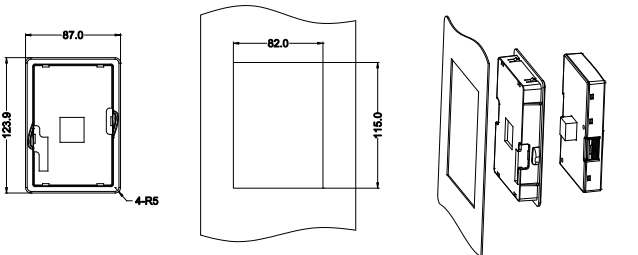

Keypad bracket

Customer installation dimension

Installation with bracket for VFDs of 380V 1.5–315kW and 660 V 22–630kW (optional)

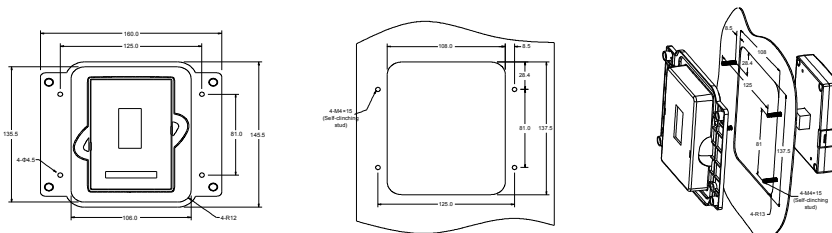

Keypad adapter bracket

Customer installation dimensions

Installation with bracket for VFDs of 380V 37–315kW and 660 V 22–630kW (standard)

C.3 VFD structure

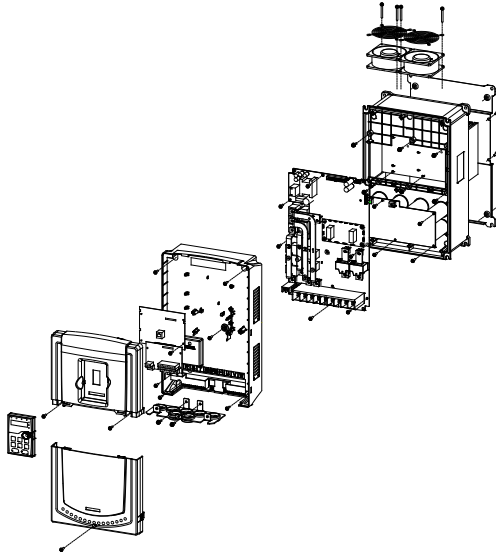

C.4 Dimensions for VFDs of AC 3PH 380V(-15%)–440V(+10%)

C.4.1 Wall installation

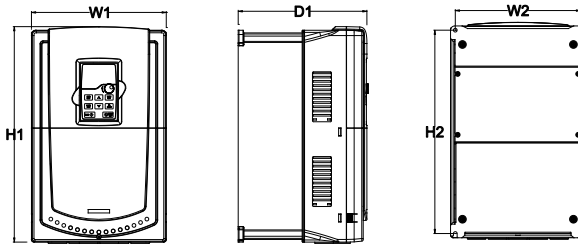

Wall installation of 380V 1.5-30kW VFDs

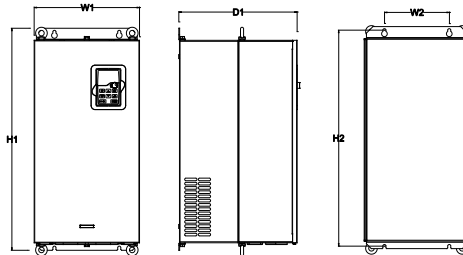

Wall installation of 380V 37-110kW VFDs

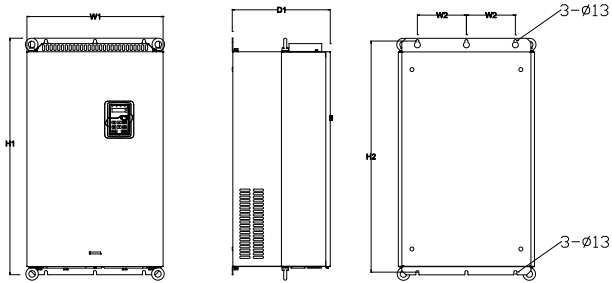

Wall installation of 380V 132-200kW VFDs

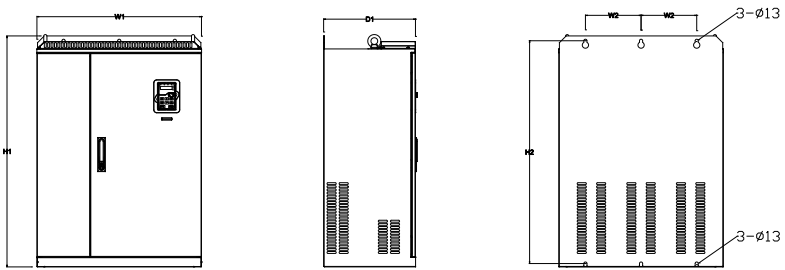

Wall installation of 380V 220-315kW VFDs

Installation dimension (unit: mm)

Model	W1	W2	H1	H2	D1	Installation hole	Weight (kg)
1.5kW-2.2kW	126	115	193	175	174.5	5	2
4kW-5.5kW	146	131	263	243.5	181	6	3.5
7.5kW-11kW	170	151	331.5	303.5	216	6	6
15kW-18.5kW	230	210	342	311	216	6	7.8
22kW-30kW	255	237	407	384	245	7	9.5
37kW-55kW	270	130	555	540	325	7	30
75kW-110kW	325	200	680	661	365	9.5	47
132kW-200kW	500	180	870	850	360	11	85
220kW-280kW	680	230	960	926	380	13	135
315kW	680	230	960	926	380	13	137

C.4.2 Flange installation

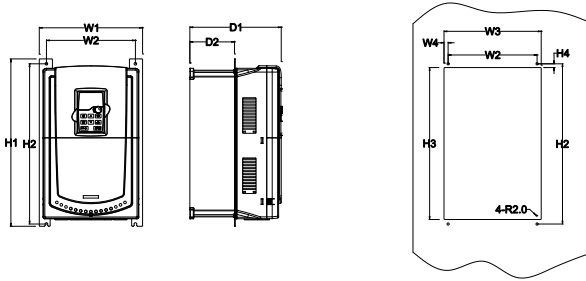

Flange installation of 380V 1.5-30kW VFDs

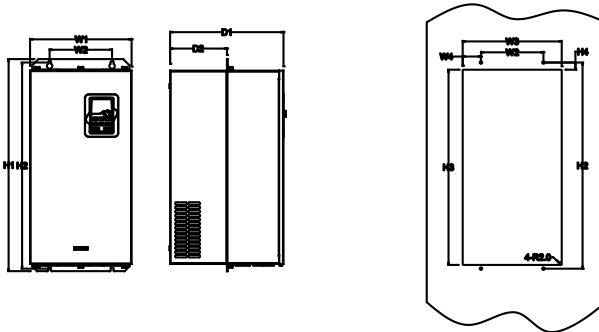

Flange installation of 380V 37-110kW VFDs

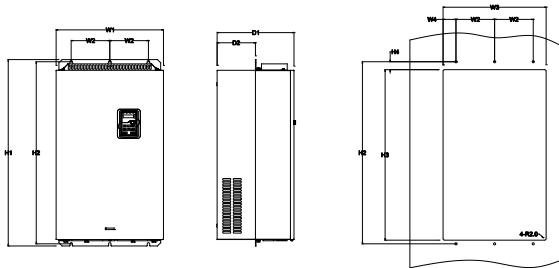

Flange installation of 380V 132-200kW VFDs

Installation dimension (unit: mm)

Model	W1	W2	W3	W4	H1	H2	H3	H4	D1	D2	Installation hole	Weight (kg)
1.5kW-2.2kW	150	115	130	7.5	234	220	190	16.5	174.5	65.5	5	2
4kW-5.5kW	170	131	150	9.5	292	276	260	10	181	79.5	6	3.5
7.5kW-11kW	191	151	174	11.5	370	351	324	15	216.2	113	6	6

Model	W1	W2	W3	W4	H1	H2	H3	H4	D1	D2	Installation hole	Weight (kg)
15kW-18.5kW	250	210	234	12	375	356	334	10	216	108	6	7.8
22kW-30kW	275	237	259	11	445	426	404	10	245	119	7	9.5
37kW-55kW	270	130	261	65.5	555	540	516	17	325	167	7	30
75kW-110kW	325	200	317	58.5	680	661	626	23	363	182	9.5	47
132kW-200kW	500	180	480	60	870	850	796	37	358	178.5	11	85

C.4.3 Floor installation

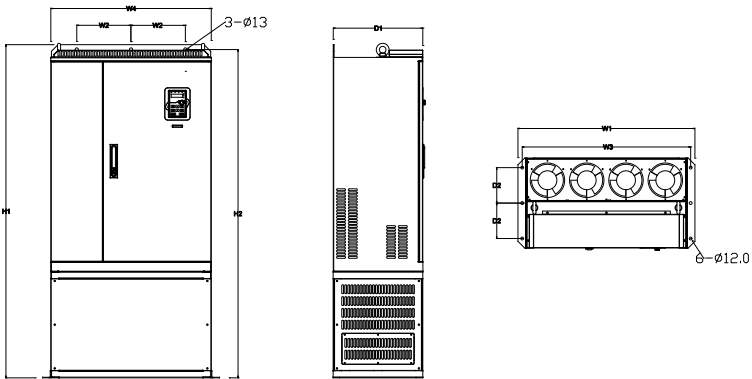

Floor installation of 380V 220-315kW VFDs

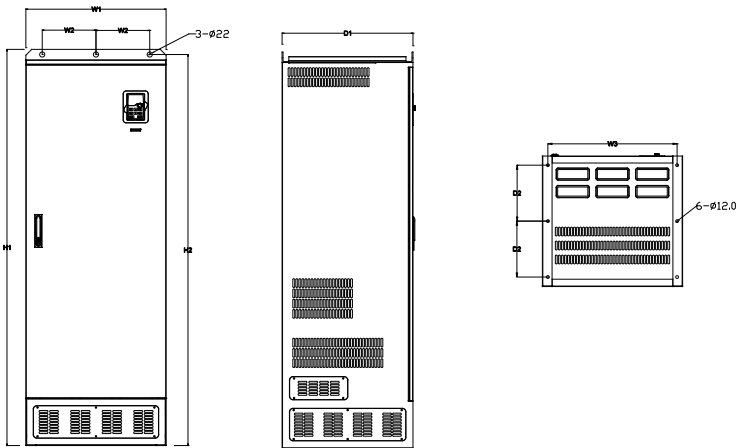

Floor installation of 380V 350-500kW VFDs

Model	W1	W2	W3	W4	H1	H2	D1	D2	Installation hole	Weight (kg)
220kW–280kW	750	230	714	680	1410	1390	380	150	13\12	135
315kW	750	230	714	680	1410	1390	380	150	13\12	137
350kW–500kW	620	230	573	\	1700	1678	560	240	22\12	410

C.5 Dimensions for VFDs of AC 3PH 380V (-10%)–550V (+10%)

C.5.1 Wall installation

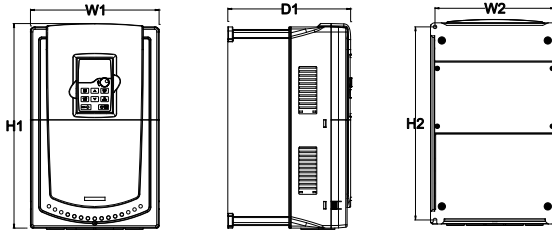

Wall installation of 500V 4-18.5kW VFDs

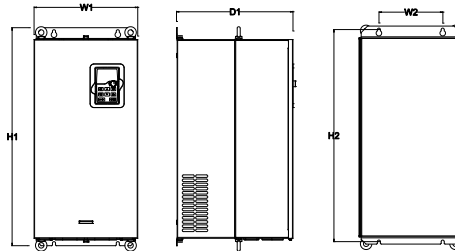

Wall installation of 500V 22-75kW VFDs

Installation dimension (unit:mm)

Model	W1	W2	H1	H2	D1	Installation hole	Weight (kg)
4kW–18.5kW	170	151	331.5	303.5	216	6	6
22kW–55kW	270	130	555	540	325	7	30
75kW	325	200	680	661	365	9.5	47

C.5.2 Flange installation

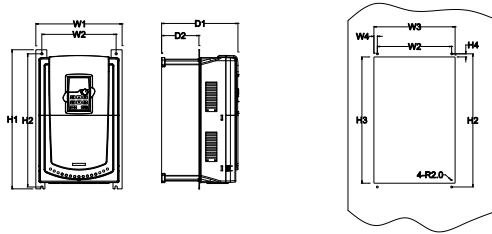

Flange installation of 500V 4-18.5kW VFDs

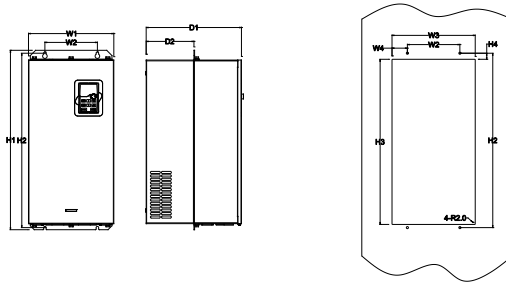

Flange installation of 500V 22-75kW VFDs

Installation dimension (unit: mm)

Model	W1	W2	W3	W4	H1	H2	H3	H4	D1	D2	Installation hole	Weight (kg)
4kW-18.5kW	191	151	174	11.5	370	351	324	15	216.2	113	6	6
22kW-55kW	270	130	261	65.5	555	540	516	17	325	167	7	30
75kW	325	200	317	58.5	680	661	626	23	363	182	9.5	47

C.6 Dimensions for VFDs of AC 3PH 520V (-15%)–690V (+10%)

C.6.1 Wall installation

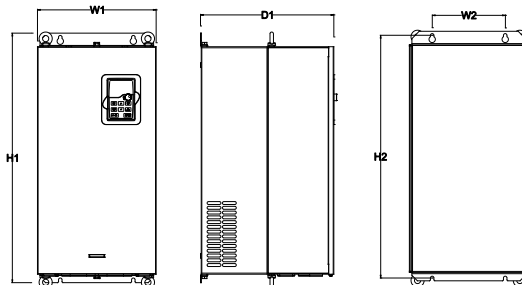

Wall installation of 660V 22-132kW VFDs

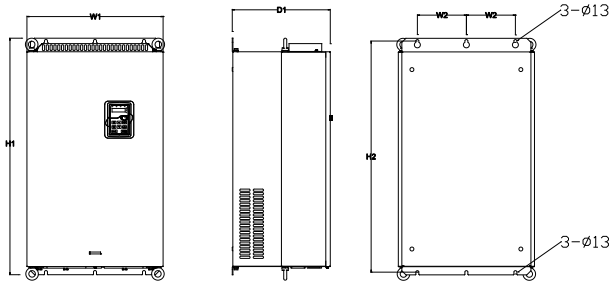

Wall installation of 660V 160-220kW VFDs

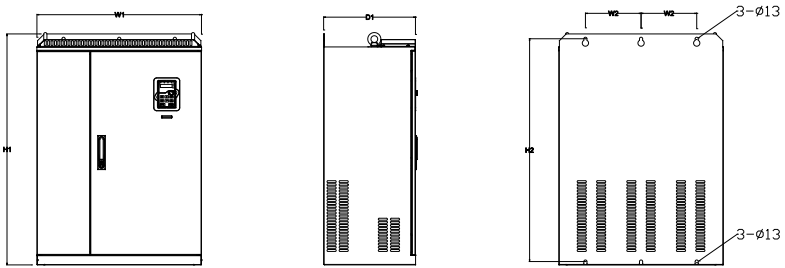

Wall installation of 660V 250-350kW VFDs

Installation dimension (unit: mm)

Model	W1	W2	H1	H2	D1	Installation hole	Weight (kg)
22kW-45kW	270	130	555	540	325	7	30
55kW-132kW	325	200	680	661	365	9.5	47
160kW-220kW	500	180	870	850	360	11	85
250kW-350kW	680	230	960	926	380	13	135

C.6.2 Flange installation

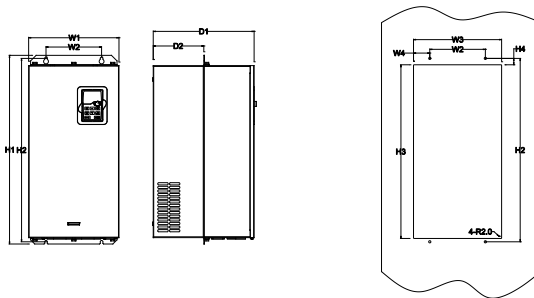

Flange installation of 660V 22-132kW VFDs

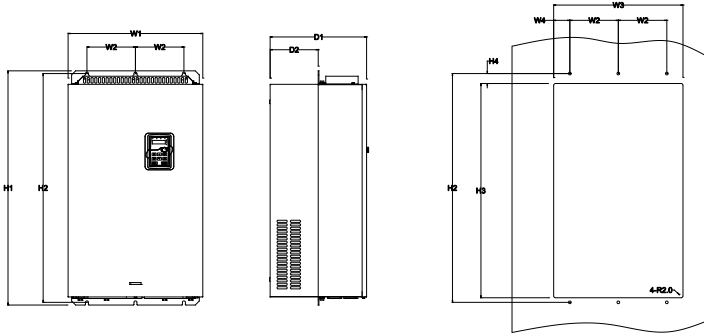

Flange installation of 660V 160-220kW VFDs

Model	W1	W2	W3	W4	H1	H2	H3	H4	D1	D2	Installation hole	Weight (kg)
22kW-45kW	270	130	261	65.5	555	540	516	17	325	167	7	30
55kW-132kW	325	200	317	58.5	680	661	626	23	363	182	9.5	47
160kW-220kW	500	180	480	60	870	850	796	37	358	178.5	11	85

C.6.3 Floor installation

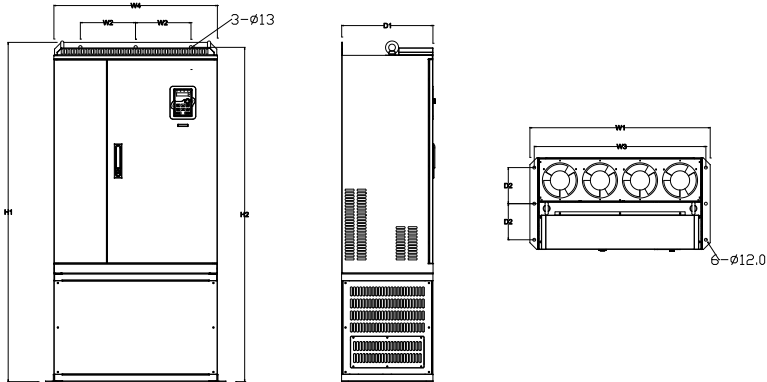

Floor installation of 660V 250-350kW VFDs

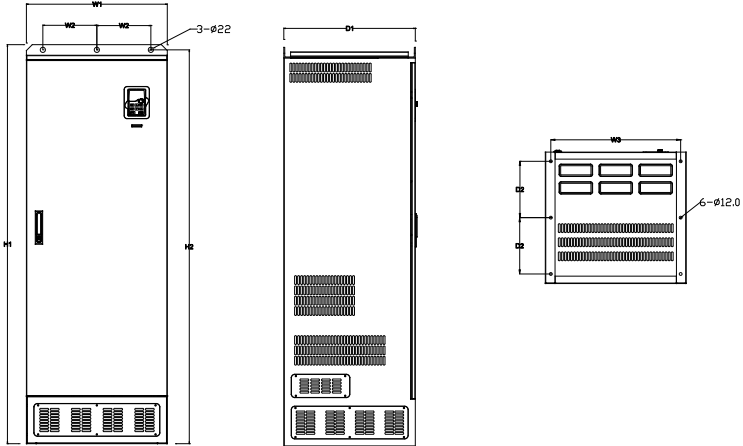

Floor installation of 660V 400-630kW VFDs

Model	W1	W2	W3	W4	H1	H2	D1	D2	Installation hole	Weight (kg)
250kW-350kW	750	230	714	680	1410	1390	380	150	13\12	135
400kW-630kW	620	230	573	\	1700	1678	560	240	22\12	390

Appendix D Peripheral options and parts

D.1 What this chapter contains

This chapter describes how to select the options and parts of Goodrive300 series.





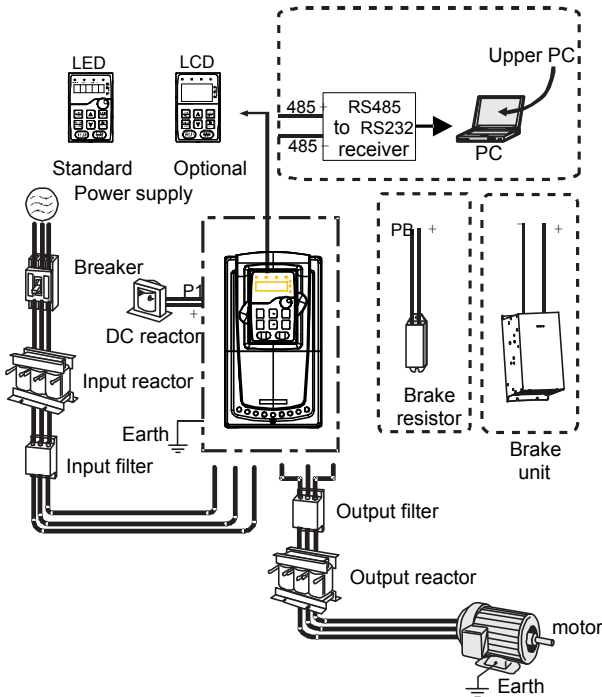

D.2 Peripheral wiring

Below is the peripheral wiring of Goodrive300 series VFDs.

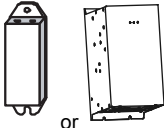

Note:

1. The VFD of 380V ($\leq 30\text{kW}$) are embedded with braking unit.
2. The VFDs of 380V ($\geq 37\text{kW}$) and of 660V have P1 terminal and are connected with external DC reactors.
3. The VFD of 500V ($\leq 18.5\text{kW}$) are embedded with braking unit.
4. The VFDs of 500V ($\geq 22\text{kW}$) have P1 terminal and are connected with external DC reactors.
5. The VFDs of 660V have P1 terminal and are connected with external DC reactors.
6. The braking units apply standard braking units. Refer to the instruction of DBU for detailed information.

Pictures	Name	Descriptions
	Cables	Device to transfer the electronic signals
	Breaker	Prevent from electric shock and protect the power supply and the cables system from overcurrent when short circuits occur. (Please select the breaker with the function of reducing high order harmonic and the rated sensitive current to 1 VFD should be above 30mA).
	Input reactor	This device is used to improve the power factor of the input side of the VFD and control the higher harmonic current.
	DC reactor	The VFDs of 380V ($\geq 37\text{kW}$), 500V ($\geq 22\text{kW}$) and of 660V have external DC reactors.
	Input filter	Control the electromagnetic interference generated from the VFD, please install close to the input terminal side of the VFD.
	Braking unit or resistors	Accessories used to consume the regenerative energy of the motor to reduce the deceleration time. VFDs of 380 V ($\leq 30\text{kW}$), and 500V ($\leq 18.5\text{kW}$) need only to be configured with brake resistors, those of 380V ($\geq 37\text{kW}$), 500V ($\geq 22\text{kW}$) and of 660V also need to be configured with brake units.
	Output filter	Control the interference from the output side of the VFD and please install close to the output terminals of the VFD.
	Output reactor	Prolong the effective transmitting distance of the VFD to control the sudden high voltage when switching on/off the inverter unit of the VFD.

D.3 Power supply

Please refer to Chapter 4 "Installation guide".

	<ul style="list-style-type: none"> • Check that the voltage degree of the VFD complies with that of the grid.
---	--

D.4 Cables

D.4.1 Power cables

Dimension the input power and motor cables according to local regulations.

- The input power and the motor cables must be able to carry the corresponding load currents.
- The cable must be rated for at least 70 °C maximum permissible temperature of the conductor in continuous use.
- The conductivity of the PE conductor must be equal to that of the phase conductor (same cross-sectional area).
- For details about the EMC requirements, see Appendix B "Technical data".

To meet the EMC requirements stipulated in the CE standards, you must use symmetrical shielded cables as motor cables (as shown in the following figure).

Four-core cables can be used as input cables, but symmetrical shielded cables are recommended. Compared with four-core cables, symmetrical shielded cables can reduce electromagnetic radiation as well as the current and loss of the motor cables.

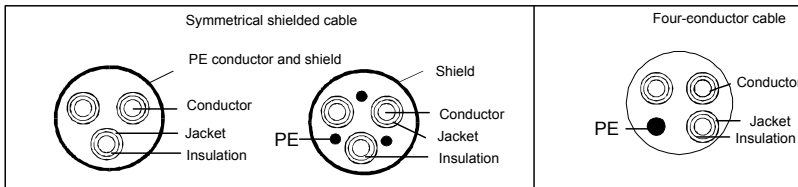

Note: If the conductivity of the shield layer of the motor cables cannot meet the requirements, separate PE conductors must be used.

To protect the conductors, the cross-sectional area of the shielded cables must be the same as that of the phase conductors if the cable and conductor are made of materials of the same type. This reduces grounding resistance, and thus improves impedance continuity.

To effectively restrict the emission and conduction of radio frequency (RF) interference, the conductivity of the shielded cable must at least be 1/10 of the conductivity of the phase conductor. This requirement can be well met by a copper or aluminum shield layer. The following figure shows the minimum requirement on motor cables of a VFD. The cable must consist of a layer of spiral-shaped copper strips. The denser the shield layer is, the more effectively the electromagnetic interference is restricted.

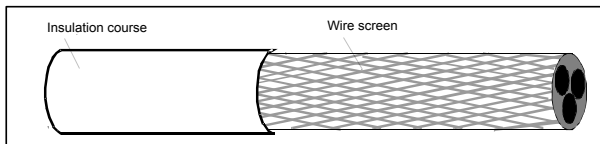

Cross-section of the cable

D.4.2 Control cables

All analog control cables and cables used for frequency input must be shielded cables. Analog signal cables need to be double-shielded twisted-pair cables (as shown in figure a). Use one separate shielded twisted pair for each signal. Do not use the same ground wire for different analog signals.

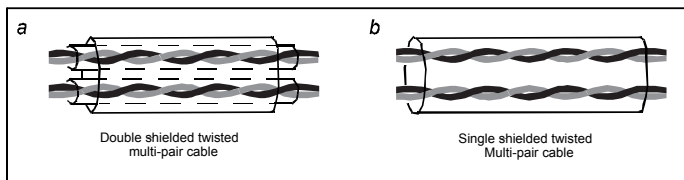

Configuration of the power cable

For low-voltage digital signals, double-shielded cables are recommended, but shielded or unshielded twisted pairs (as shown in figure b) also can be used. For frequency signals, however, only shielded cables can be used.

Relay cables need to be those with metal braided shield layers.

Keypads need to be connected by using network cables. In complicated electromagnetic environments, shielded network cables are recommended.

Note: Analog signals and digital signals cannot use the same cables, and their cables must be arranged separately.

Do not perform any voltage endurance or insulation resistance tests, such as high-voltage insulation tests or using a megameter to measure the insulation resistance, on the VFD or its components. Insulation and voltage endurance tests have been performed between the main circuit and chassis of each VFD before delivery. In addition, voltage limiting circuits that can automatically cut off the test voltage are configured inside the VFDs.

Note: Check the insulation conditions of the input power cable of a VFD according to the local regulations before connecting it.

D.4.2.1 The VFDs of AC 3PH 380V(-15%)–440V(+10%)

Model	Recommended cable size (mm ²)		Connecting cable size (mm ²)				Terminal screw	Tightening torque (Nm)
	RST UVW	PE	RST UVW	P1, (+)	PB (+),(-)	PE		
GD300-1R5G-4	2.5	2.5	2.5–6	2.5–6	2.5–6	2.5–6	M4	1.2–1.5
GD300-2R2G-4	2.5	2.5	2.5–6	2.5–6	2.5–6	2.5–6	M4	1.2–1.5
GD300-004G-4	2.5	2.5	2.5–6	2.5–6	2.5–6	2.5–6	M4	1.2–1.5
GD300-5R5G-4	2.5	2.5	2.5–6	4–6	4–6	2.5–6	M4	1.2–1.5
GD300-7R5G-4	4	4	4–16	4–16	4–16	4–16	M5	2–2.5
GD300-011G-4	6	6	6–16	6–16	6–16	6–16	M5	2–2.5
GD300-015G-4	10	10	10–25	10–25	10–25	6–25	M5	2–2.5

Model	Recommended cable size (mm ²)		Connecting cable size (mm ²)				Terminal screw	Tightening torque (Nm)
	RST UVW	PE	RST UVW	P1, (+)	PB (+),(-)	PE		
GD300-018G-4	16	16	16-25	16-25	16-25	10-25	M5	2-2.5
GD300-022G-4	16	16	16-25	16-25	16-25	10-25	M6	4-6
GD300-030G-4	25	16	16-25	16-25	16-25	16-25	M6	4-6
GD300-037G-4	25	16	25-50	25-50	25-50	16-50	M8	9-11
GD300-045G-4	35	16	25-50	25-50	25-50	16-50	M8	9-11
GD300-055G-4	50	25	50-95	50-95	50-95	25-50	M8	9-11
GD300-075G-4	70	35	70-95	70-95	70-95	35-50	M10	18-23
GD300-090G-4	95	50	95-150	95-150	95-150	50-150	M10	18-23
GD300-110G-4	120	70	95-300	95-300	95-300	70-240	M10	18-23
GD300-132G-4	185	95	95-300	95-300	95-300	95-240	It is recommended to use wrench or sleeve because screw is used as terminal.	
GD300-160G-4	240	120	95-300	95-300	95-300	120-240		
GD300-200G-4	95×2P	120	95×2P -150×2P	95×2P -150×2P	95×2P -150×2P	120-240		
GD300-220G-4	150×2P	150	95×2P -150×2P	95×2P -150×2P	95×2P -150×2P	150-240		
GD300-250G-4	95×4P	95×2P	95×4P -150×4P	95×4P -150×4P	95×4P -150×4P	95×2P -150×2P		
GD300-280G-4	95×4P	95×2P	95×4P -150×4P	95×4P -150×4P	95×4P -150×4P	95×2P -150×2P		
GD300-315G-4	95×4P	95×4P	95×4P -150×4P	95×4P -150×4P	95×4P -150×4P	95×2P -150×2P		
GD300-350G-4	95×4P	95×4P	95×4P -150×4P	95×4P -150×4P	95×4P -150×4P	95×2P -150×2P		
GD300-400G-4	150×4P	150×2P	95×4P -150×4P	95×4P -150×4P	95×4P -150×4P	95×2P -150×2P		
GD300-500G-4	150×4P	150×2P	95×4P -150×4P	95×4P -150×4P	95×4P -150×4P	95×2P -150×2P		

Note:

1. Cables of the sizes recommended for the main circuit can be used in scenarios where the ambient temperature is lower than 40°C, the wiring distance is shorter than 100 m, and the current is the rated current.
2. The terminals P1, (+), and (-) are used to connect to DC reactors and brake accessories.

D.4.2.2 AC 3PH 380V(-10%)–550V(+10%)

Model	Recommended cable size (mm ²)		Connecting cable size (mm ²)				Terminal screw	Tightening torque (Nm)
	RST UVW	PE	RST UVW	P1, (+)	PB (+),(-)	PE		
GD300-004G-5	2.5	2.5	2.5–6	2.5–6	2.5–6	2.5–6	M5	2–2.5
GD300-5R5G-5	2.5	2.5	2.5–6	2.5–6	2.5–6	2.5–6	M5	2–2.5
GD300-7R5G-5	2.5	2.5	2.5–6	4–6	4–6	2.5–6	M5	2–2.5
GD300-011G-5	4	4	4–16	4–16	4–16	4–16	M5	2–2.5
GD300-015G-5	6	6	6–16	6–16	6–16	6–16	M5	2–2.5
GD300-018G-5	10	10	10–16	10–16	10–16	10–16	M5	2–2.5
GD300-022G-5	16	16	16–50	16–50	16–50	16–50	M8	9–11
GD300-030G-5	16	16	16–50	16–50	16–50	16–50	M8	9–11
GD300-037G-5	25	16	25–50	25–50	25–50	16–50	M8	9–11
GD300-045G-5	25	16	25–50	25–50	25–50	16–50	M8	9–11
GD300-055G-5	35	16	35–50	35–50	35–50	16–50	M8	9–11
GD300-075G-5	50	25	50–95	50–95	50–95	25–95	M10	18–23

Note:

1. Cables of the sizes recommended for the main circuit can be used in scenarios where the ambient temperature is lower than 40°C, the wiring distance is shorter than 100 m, and the current is the rated current.

2. The terminals P1, (+), and (-) are used to connect to DC reactors and brake accessories.

D.4.2.3 The VFDs of AC 3PH 520V(-15%)–690V(+10%)

Model	Recommended cable size (mm ²)		Connecting cable size (mm ²)				Terminal screw	Tightening torque (Nm)
	RST UVW	PE	RST UVW	P1,(+)	PB (+),(-)	PE		
GD300-022G-6	10	10	10–16	6–16	6–10	6–16	M8	9–11
GD300-030G-6	10	10	10–16	6–16	6–10	6–16	M8	9–11
GD300-037G-6	16	16	16–25	16–25	6–10	10–16	M8	9–11
GD300-045G-6	16	16	10–16	16–35	10–16	10–16	M8	9–11
GD300-055G-6	25	16	16–25	16–35	16–25	16–25	M10	18–23
GD300-075G-6	35	16	25–50	25–50	25–50	16–25	M10	18–23
GD300-090G-6	35	16	25–50	25–50	25–50	16–25	M10	18–23
GD300-110G-6	50	25	35–95	50–95	25–95	25	M10	18–23
GD300-132G-6	70	35	70–95	35–95	50–75	25–35	M10	18–23
GD300-160G-6	95	50	35–95	35–150	25–70	50–150	It is recommended to use wrench or	
GD300-185G-6	95	50	35–95	35–150	25–70	50–150		

Model	Recommended cable size (mm ²)		Connecting cable size (mm ²)				Terminal screw	Tightening torque (Nm)
	RST UVW	PE	RST UVW	P1,(+)	PB (+),(-)	PE		
GD300-200G-6	120	70	95-300	70-300	35-300	70-240	sleeve because screw is used as terminal.	
GD300-220G-6	185	95	95-300	70-300	35-300	95-240		
GD300-250G-6	185	95	95-300	70-300	35-300	95-240		
GD300-280G-6	240	120	95-300	95-300	70-300	120-240		
GD300-315G-6	95×2P	95	95-150	70-150	70-150	35-95		
GD300-350G-6	95×2P	95	95-150	70-150	70-150	35-95		
GD300-400G-6	150×2P	150	95-150	70-150	70-150	50-150		
GD300-500G-6	95×4P	95×2P	95-150	70-150	70-150	70-150		
GD300-560G-6	95×4P	95×4P	95-150	70-150	70-150	70-150		
GD300-630G-6	150×4P	150×2P	95-150	70-150	70-150	70-150		

Note:

1. Cables of the sizes recommended for the main circuit can be used in scenarios where the ambient temperature is lower than 40°C, the wiring distance is shorter than 100 m, and the current is the rated current.
2. The terminals P1, (+), and (-) are used to connect to DC reactors and brake accessories.

D.4.3 Routing the cables

Route the motor cable away from other cable routes. Motor cables of several drives can be run in parallel installed next to each other. It is recommended that the motor cable, input power cable and control cables are installed on separate trays. Avoid long parallel runs of motor cables with other cables to decrease electromagnetic interference caused by the rapid changes in the drive output voltage.

Where control cables must cross power cables make sure that they are arranged at an angle as near to 90 degrees as possible.

The cable trays must have good electrical bonding to each other and to the grounding electrodes. Aluminum tray systems can be used to improve local equalizing of potential.

A figure of the cable routing is shown below.

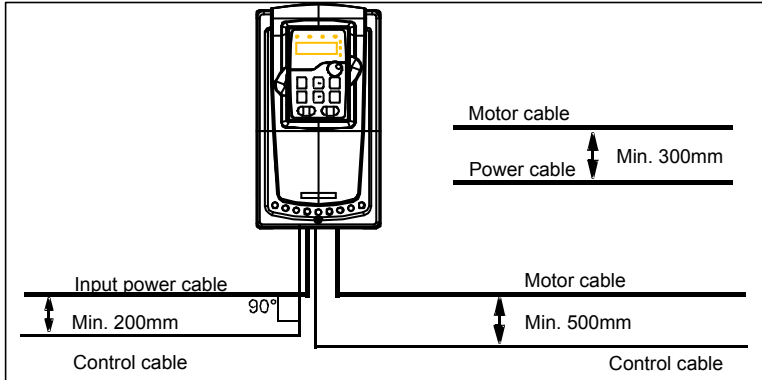

Wiring layout distances

D.4.4 Insulation checking

Check the insulation of the motor and motor cable as follows:

1. Check that the motor cable is connected to the motor and disconnected from the drive output terminals U, V and W.
2. Measure the insulation resistance between each phase conductor and the Protective Earth conductor using a measuring voltage of 500 V DC. For the insulation resistance of other motors, please consult the manufacturer's instructions.

Note: Moisture inside the motor casing will reduce the insulation resistance. If moisture is suspected, dry the motor and repeat the measurement.

D.5 Breaker and electromagnetic contactor

You need to add a fuse to prevent overload.

You need to configure a manually manipulated molded case circuit breaker (MCCB) between the AC power supply and VFD. The breaker must be locked in the open state to facilitate installation and inspection. The capacity of the breaker needs to be 1.5 to 2 times the rated current of the VFD.



- Due to the inherent operating principle and construction of circuit breakers, independent of the manufacturer, hot ionized gases may escape from the breaker enclosure in case of a short-circuit. To ensure safe use, special attention must be paid to the installation and placement of the breakers. Follow the manufacturer's instructions.

To ensure safety, you can configure an electromagnetic contactor on the input side to control the switch-on and switch-off of the main circuit power, so that the input power supply of the VFD can be effectively cut off when a system fault occurs.

D.5.1 The VFDs of AC 3PH 380V (-15%)–440V(+10%)

Model	Fuse (A)	Breaker (A)	The rated working current of the contactor(A)
GD300-1R5G-4	15	16	10
GD300-2R2G-4	17.4	16	10
GD300-004G-4	30	25	16
GD300-5R5G-4	45	25	16
GD300-7R5G-4	60	40	25
GD300-011G-4	78	63	32
GD300-015G-4	105	63	50
GD300-018G-4	114	100	63
GD300-022G-4	138	100	80
GD300-030G-4	186	125	95
GD300-037G-4	228	160	120
GD300-045G-4	270	200	135
GD300-055G-4	315	200	170
GD300-075G-4	420	250	230
GD300-090G-4	480	315	280
GD300-110G-4	630	400	315
GD300-132G-4	720	400	380
GD300-160G-4	870	630	450
GD300-200G-4	1110	630	580
GD300-220G-4	1230	800	630
GD300-250G-4	1380	800	700
GD300-280G-4	1500	1000	780
GD300-315G-4	1740	1200	900
GD300-350G-4	1860	1280	960
GD300-400G-4	2010	1380	1035
GD300-500G-4	2505	1720	1290

Note: The accessory specifications described in the preceding table are ideal values. You can select accessories based on the actual market conditions, but try not to use those with lower values.

D.5.2 AC 3PH 380V(-10%)V–550V(+10%)

Model	Fuse (A)	Breaker (A)	The rated working current of the contactor(A)
GD300-004G-5	30	25	16
GD300-5R5G-5	30	25	16
GD300-7R5G-5	45	25	16

Model	Fuse (A)	Breaker (A)	The rated working current of the contactor(A)
GD300-011G-5	60	40	25
GD300-015G-5	78	63	32
GD300-018G-5	105	63	50
GD300-022G-5	114	100	63
GD300-030G-5	186	125	95
GD300-037G-5	186	125	95
GD300-045G-5	228	160	120
GD300-055G-5	315	200	170
GD300-075G-5	315	200	170

Note: The accessory specifications described in the preceding table are ideal values. You can select accessories based on the actual market conditions, but try not to use those with lower values.

D.5.3 The VFDs of AC 3PH 520V(-15%)–690V(+10%)

Model	Fuse (A)	Breaker (A)	The rated working current of the contactor(A)
GD300-022G-6	105	63	50
GD300-030G-6	105	63	50
GD300-037G-6	114	100	63
GD300-045G-6	138	100	80
GD300-055G-6	186	125	95
GD300-075G-6	270	200	135
GD300-090G-6	270	200	135
GD300-110G-6	315	200	170
GD300-132G-6	420	250	230
GD300-160G-6	480	315	280
GD300-185G-6	480	315	280
GD300-200G-6	630	400	315
GD300-220G-6	720	400	380
GD300-250G-6	720	400	380
GD300-280G-6	870	630	450
GD300-315G-6	1110	630	580
GD300-350G-6	1110	630	580
GD300-400G-6	1230	800	630
GD300-500G-6	1500	1000	780
GD300-560G-6	1740	1200	900

Model	Fuse (A)	Breaker (A)	The rated working current of the contactor(A)
GD300-630G-6	2010	1380	1035

Note: The accessory specifications described in the preceding table are ideal values. You can select accessories based on the actual market conditions, but try not to use those with lower values.

D.6 Reactors

When the voltage of the grid is high, the transient large current that flows into the input power circuit may damage rectifier components. You need to configure an AC reactor on the input side, which can also improve the current adjustment coefficient on the input side.

When the distance between the VFD and motor is longer than 50 m, the parasitic capacitance between the long cable and ground may cause large leakage current, and overcurrent protection of the VFD may be frequently triggered. To prevent this from happening and avoid damage to the motor insulator, compensation must be made by adding an output reactor. When a VFD is used to drive multiple motors, take the total length of the motor cables (that is, sum of the lengths of the motor cables) into account. When the total length is longer than 50 m, an output reactor must be added on the output side of the VFD. If the distance between the VFD and motor is 50 m to 100 m, select the reactor according to the following table. If the distance is longer than 100 m, contact INVT's technical support technicians.

The VFDs of 380V (≥37Kw), 500V (≥22Kw) and of 660V are equipped with internal DC reactors for the improvement of power factors and the avoidance of damage from high input current to the rectifying components because of the high-capacity transformer. The device can also cease the damage to the rectifying components which are caused by supply net voltage transients and harmonic waves of the loads.

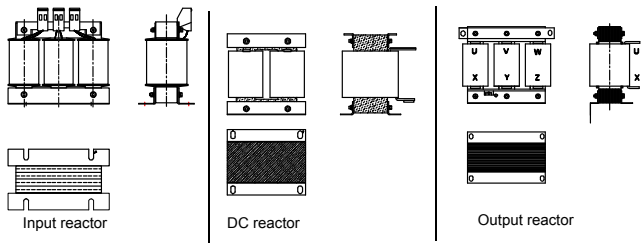

D.6.1 AC 3PH 380V(-15%)–440V(+10%)

Model	Input reactor	DC reactor	Output reactor
GD300-1R5G-4	ACL2-1R5-4	/	OCL2-1R5-4
GD300-2R2G-4	ACL2-2R2-4	/	OCL2-2R2-4
GD300-004G-4	ACL2-004-4	/	OCL2-004-4
GD300-5R5G-4	ACL2-5R5-4	/	OCL2-5R5-4
GD300-7R5G-4	ACL2-7R5-4	/	OCL2-7R5-4

Model	Input reactor	DC reactor	Output reactor
GD300-011G-4	ACL2-011-4	/	OCL2-011-4
GD300-015G-4	ACL2-015-4	/	OCL2-015-4
GD300-018G-4	ACL2-018-4	/	OCL2-018-4
GD300-022G-4	ACL2-022-4	/	OCL2-022-4
GD300-030G-4	ACL2-030-4	/	OCL2-030-4
GD300-037G-4	ACL2-037-4	DCL2-037-4	OCL2-037-4
GD300-045G-4	ACL2-045-4	DCL2-045-4	OCL2-045-4
GD300-055G-4	ACL2-055-4	DCL2-055-4	OCL2-055-4
GD300-075G-4	ACL2-075-4	DCL2-075-4	OCL2-075-4
GD300-090G-4	ACL2-110-4	DCL2-090-4	OCL2-110-4
GD300-110G-4	ACL2-110-4	DCL2-132-4	OCL2-110-4
GD300-132G-4	ACL2-132-4	DCL2-132-4	OCL2-132-4
GD300-160G-4	ACL2-160-4	DCL2-160-4	OCL2-160-4
GD300-200G-4	ACL2-200-4	DCL2-220-4	OCL2-200-4
GD300-220G-4	ACL2-250-4	DCL2-220-4	OCL2-250-4
GD300-250G-4	ACL2-250-4	DCL2-280-4	OCL2-250-4
GD300-280G-4	ACL2-280-4	DCL2-280-4	OCL2-280-4
GD300-315G-4	ACL2-315-4	DCL2-315-4	OCL2-315-4
GD300-350G-4	Standard	DCL2-400-4	OCL2-350-4
GD300-400G-4	Standard	DCL2-400-4	OCL2-400-4
GD300-500G-4	Standard	DCL2-500-4	OCL2-500-4

Note:

1. The rated derate voltage of the input reactor is 2%±15%.
2. The power factor of the input side is above 90% after installing DC reactor.
3. The rated derate voltage of the output reactor is 1%±15%.
4. Above options are external, the customer should indicate when purchasing.

D.6.2 AC 3PH 380V(-10%)V-550V(+10%)

Model	Input reactor	DC reactor	Output reactor
GD300-004G-5	/	/	/
GD300-5R5G-5	/	/	/
GD300-7R5G-5	/	/	/
GD300-011G-5	/	/	/
GD300-015G-5	ACL2-030-6	/	OCL2-030-6
GD300-018G-5	ACL2-030-6	/	OCL2-030-6
GD300-022G-5	ACL2-055-6	DCL2-055-6	OCL2-055-6
GD300-030G-5	ACL2-055-6	DCL2-055-6	OCL2-055-6

Model	Input reactor	DC reactor	Output reactor
GD300-037G-5	ACL2-110-6	DCL2-110-6	OCL2-110-6
GD300-045G-5	ACL2-110-6	DCL2-110-6	OCL2-110-6
GD300-055G-5	ACL2-110-6	DCL2-110-6	OCL2-110-6
GD300-075G-5	ACL2-110-6	DCL2-110-6	OCL2-110-6

Note:

1. The rated derate voltage of the input reactor is 2%±15%.
2. The power factor of the input side is above 90% after installing DC reactor.
3. The rated derate voltage of the output reactor is 1%±15%.
4. Above options are external, the customer should indicate when purchasing.

D.6.3 AC 3PH 520V(-15%)–690V(+10%)

Model	Input reactor	DC reactor	Output reactor
GD300-022G-6	ACL2-030-6	DCL2-030-6	OCL2-030-6
GD300-030G-6	ACL2-030-6	DCL2-030-6	OCL2-030-6
GD300-037G-6	ACL2-055-6	DCL2-055-6	OCL2-055-6
GD300-045G-6	ACL2-055-6	DCL2-055-6	OCL2-055-6
GD300-055G-6	ACL2-055-6	DCL2-055-6	OCL2-055-6
GD300-075G-6	ACL2-110-6	DCL2-110-6	OCL2-110-6
GD300-090G-6	ACL2-110-6	DCL2-110-6	OCL2-110-6
GD300-110G-6	ACL2-110-6	DCL2-110-6	OCL2-110-6
GD300-132G-6	ACL2-185-6	DCL2-185-6	OCL2-185-6
GD300-160G-6	ACL2-185-6	DCL2-185-6	OCL2-185-6
GD300-185G-6	ACL2-185-6	DCL2-185-6	OCL2-185-6
GD300-200G-6	ACL2-250-6	DCL2-250-6	OCL2-250-6
GD300-220G-6	ACL2-250-6	DCL2-250-6	OCL2-250-6
GD300-250G-6	ACL2-250-6	DCL2-250-6	OCL2-250-6
GD300-280G-6	ACL2-350-6	DCL2-350-6	OCL2-350-6
GD300-315G-6	ACL2-350-6	DCL2-350-6	OCL2-350-6
GD300-350G-6	ACL2-350-6	DCL2-350-6	OCL2-350-6
GD300-400G-6	Standard	DCL2-400-6	OCL2-400-6
GD300-500G-6	Standard	DCL2-560-6	OCL2-560-6
GD300-560G-6	Standard	DCL2-560-6	OCL2-560-6
GD300-630G-6	Standard	DCL2-630-6	OCL2-630-6

Note:

1. The rated derate voltage of the input reactor is 2%±15%.
2. The power factor of the input side is above 90% after installing DC reactor.

3. The rated derate voltage of the output reactor is 1%±15%.
4. Above options are external, the customer should indicate when purchasing.

D.7 Filter

J10 is not connected in factory for VFDs of 380V (≤ 110kW). Connect the J10 packaged with the manual if the requirements of level C3 need to be met.

J10 is connected in factory for VFDs of 380V (≥ 132kW), all of which meet the requirements of level C3.

Note:

Disconnect J10 in the following situations:

1. The EMC filter is applicable to neutral-grounded grid system. If it is used for IT grid system (that is, non- neutral grounded grid system), disconnect the J10.
2. If leakage protection occurs when configuring the residual-current circuit breaker, disconnect J10.

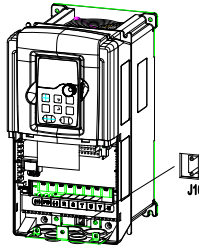

Note: Do not connect C3 filters in IT power systems.

Interference filters on the input side can reduce the interference of VFDs (when used) on the surrounding devices.

Noise filters on the output side can decrease the radio noise caused by the cables between VFDs and motors and the leakage current of conducting wires.

INVT provides some of the filters for users to choose.

D.7.1 Filter type instruction

FLT - P 04 045 L - B
A B C D E F

Character designation	Detailed instruction
A	FLT: VFD filter series
B	Filter type P: power supply filter L: output filter

Character designation	Detailed instruction
C	Voltage degree 04: AC 3PH 380V (-15%)–440V(+10%) 06: AC 3PH 520V (-15%)–690V(+10%)
D	3 bit rated current code "015" means 15A
E	Installation type L: Common type H: High performance type
F	Filter application environment A: Environment Category I, C1 (EN 61800-3:2004) B: Environment Category I, C2 (EN 61800-3:2004) C: Environment Category II, C3 (EN 61800-3:2004)

D.7.2 AC 3PH 380V(-15%)–440V(+10%)

Model	Input filter	Output filter
GD300-1R5G-4	FLT-P04006L-B	FLT-L04006L-B
GD300-2R2G-4		
GD300-004G-4	FLT-P04016L-B	FLT-L04016L-B
GD300-5R5G-4		
GD300-7R5G-4	FLT-P04032L-B	FLT-L04032L-B
GD300-011G-4		
GD300-015G-4	FLT-P04045L-B	FLT-L04045L-B
GD300-018G-4		
GD300-022G-4	FLT-P04065L-B	FLT-L04065L-B
GD300-030G-4		
GD300-037G-4	FLT-P04100L-B	FLT-L04100L-B
GD300-045G-4		
GD300-055G-4	FLT-P04150L-B	FLT-L04150L-B
GD300-075G-4		
GD300-090G-4	FLT-P04240L-B	FLT-L04240L-B
GD300-110G-4		
GD300-132G-4	FLT-P04400L-B	FLT-L04400L-B
GD300-160G-4		
GD300-200G-4	FLT-P04600L-B	FLT-L04600L-B
GD300-220G-4		
GD300-250G-4	FLT-P04800L-B	FLT-L04800L-B
GD300-280G-4		
GD300-315G-4	FLT-P04800L-B	FLT-L04800L-B
GD300-350G-4		

Model	Input filter	Output filter
GD300-400G-4		
GD300-500G-4	FLT-P041000L-B	FLT-L041000L-B

Note:

1. The input EMI meet the requirement of C2 after installing input filters.
2. Above options are external, the customer should indicate when purchasing.

D.7.3 AC 3PH 380V(-10%)V-550V(+10%)

Model	Input filter	Output filter
GD300-004G-5	FLT-P06050H-B	FLT-L06050H-B
GD300-5R5G-5		
GD300-7R5G-5		
GD300-011G-5		
GD300-015G-5		
GD300-018G-5		
GD300-022G-5		
GD300-030G-5	FLT-P06100H-B	FLT-L06100H-B
GD300-037G-5		
GD300-045G-5		
GD300-055G-5		
GD300-075G-5	FLT-P06200H-B	FLT-L06200H-B

Note:

1. The input EMI meet the requirement of C2 after installing input filters.
2. Above options are external, the customer should indicate when purchasing.

D.7.4 AC 3PH 520V(-15%)–690V(+10%)

Model	Input filter	Output filter
GD300-022G-6	FLT-P06050H-B	FLT-L06050H-B
GD300-030G-6		
GD300-037G-6		
GD300-045G-6	FLT-P06100H-B	FLT-L06100H-B
GD300-055G-6		
GD300-075G-6		
GD300-090G-6		
GD300-110G-6	FLT-P06200H-B	FLT-L06200H-B
GD300-132G-6		
GD300-160G-6		
GD300-185G-6		
GD300-200G-6	FLT-P06300H-B	FLT-L06300H-B
GD300-220G-6		



Model	Input filter	Output filter
GD300-250G-6		
GD300-280G-6		
GD300-315G-6		
GD300-350G-6	FLT-P06400H-B	FLT-L06400H-B
GD300-400G-6	FLT-P061000H-B	FLT-L061000H-B
GD300-500G-6		
GD300-560G-6		
GD300-630G-6		
GD300-630G-6		

Note:

1. The input EMI meet the requirement of C2 after adding input filters.
2. Above options are external, the customer should indicate when purchasing.

D.8 Braking system**D.8.1 Selecting the braking components**

When a VFD driving a high-inertia load decelerates or needs to decelerate abruptly, the motor runs in the power generation state and transmits the load-carrying energy to the DC circuit of the VFD, causing the bus voltage of the VFD to rise. If the bus voltage exceeds a specific value, the VFD reports an overvoltage fault. To prevent this from happening, you need to configure brake components.

	<ul style="list-style-type: none"> • The design, installation, commissioning, and operation of the device must be performed by trained and qualified professionals. • Follow all the "Warning" instructions during the operation. Otherwise, major physical injuries or property loss may be caused. • Only qualified electricians are allowed to perform the wiring. Otherwise, damage to the VFD or brake components may be caused. • Read the brake resistor or unit instructions carefully before connecting them to the VFD. • Connect brake resistors only to the terminals PB and (+), and brake units only to the terminals (+) and (-). Do not connect them to other terminals. Otherwise, damage to the brake circuit and VFD and fire may be caused.
	<ul style="list-style-type: none"> • Connect the brake components to the VFD according to the wiring diagram. If the wiring is not properly performed, damage to the VFD or other devices may be caused.

D.8.1.1 AC 3PH 380V(-15%)–440V(+10%)

Goodrive300 series VFDs of 380V ($\leq 30\text{kW}$) are equipped with built-in brake units, and those of 380V ($\geq 37\text{kW}$) need to be configured with external brake units. Select brake resistors according to the specific requirements (such as the brake torque and brake usage requirements) on site.



Model	Model of braking unit	Brake resistor value matched with 100% brake torque (Ω)	Dissipation power of brake resistor (kW) (10% brake)	Dissipated power of brake resistor (kW) (50% brake)	Dissipated power of brake resistor (kW) (80% brake)	Min allowed brake resistor (Ω)
GD300-1R5G-4	Embedded braking units	326	0.23	1.1	1.8	170
GD300-2R2G-4		222	0.33	1.7	2.6	130
GD300-004G-4		122	0.6	3	4.8	80
GD300-5R5G-4		89	0.75	4.1	6.6	60
GD300-7R5G-4		65	1.1	5.6	9	47
GD300-011G-4		44	1.7	8.3	13.2	31
GD300-015G-4		32	2	11	18	23
GD300-018G-4		27	3	14	22	19
GD300-022G-4		22	3	17	26	17
GD300-030G-4		17	5	23	36	17
GD300-037G-4	DBU100H-060-4	13	6	28	44	11.7
GD300-045G-4	DBU100H-110-4	10	7	34	54	6.4
GD300-055G-4		8	8	41	66	
GD300-075G-4		6.5	11	56	90	
GD300-090G-4	DBU100H-160-4	5.4	14	68	108	4.4
GD300-110G-4		4.5	17	83	132	
GD300-132G-4	DBU100H-220-4	3.7	20	99	158	3.2
GD300-160G-4	DBU100H-320-4	3.1	24	120	192	2.2
GD300-200G-4		2.5	30	150	240	
GD300-220G-4	DBU100H-400-4	2.2	33	165	264	1.8
GD300-250G-4		2.0	38	188	300	
GD300-280G-4	Two	3.6×2	21×2	105×2	168×2	2.2×2
GD300-315G-4		3.2×2	24×2	118×2	189×2	
GD300-350G-4	DBU100H-320-4	2.8×2	27×2	132×2	210×2	
GD300-400G-4		2.4×2	30×2	150×2	240×2	
GD300-500G-4	Two DBU100H-400-4	2×2	38×2	186×2	300×2	1.8×2

Note:

1. Select the resistor and power of the brake unit according to the data our company provided.
2. The brake resistor may increase the brake torque of the VFD. The preceding table describes the resistance and power for 100% brake torque, 10% brake usage, 50% brake usage, and 80% brake

usage. You can select the brake system based on the actual operation conditions.

3. When using an external brake unit, set the brake voltage class of the brake unit properly by referring to the manual of the dynamic brake unit. If the voltage class is set incorrectly, the VFD may not run properly.

	<ul style="list-style-type: none"> Never use a brake resistor with a resistance below the minimum value specified for the particular drive. The drive and the internal chopper are not able to handle the overcurrent caused by the low resistance.
	<ul style="list-style-type: none"> Increase the power of the braking resistor properly in the frequent braking situation (the frequency usage ratio is more than 10%).

D.8.1.2 AC 3PH 380V(-10%)V-550V(+10%)



The VFDs of 500V (≤18.5kW) have embedded braking units but the VFDs of 500V (≥22kW) have optional braking units. Please select the braking resistor according to actual operation (such as the brake torque and brake usage requirements).

Model	Model of braking unit	Brake resistor value matched with 100% brake torque (Ω)	Dissipation power of brake resistor (kW) (10% brake)	Dissipated power of brake resistor (kW) (50% brake)	Dissipated power of brake resistor (kW) (80% brake)	Min allowed brake resistor (Ω)
GD300-004G-5	Embedded braking units	202.5	0.60	3.0	4.8	20
GD300-5R5G-5		147.3	0.83	4.1	6.6	20
GD300-7R5G-5		108.0	1.13	5.6	9.0	20
GD300-011G-5		73.6	1.65	8.3	13.2	20
GD300-015G-5		54.0	2.25	11.3	18.0	20
GD300-018G-5		43.8	2.78	13.9	22.2	20
GD300-022G-5	DBU100H-110-6	36.8	3.30	16.5	26.4	10.0
GD300-030G-5		27.0	4.50	22.5	36.0	10.0
GD300-037G-5		21.9	5.55	27.8	44.4	10.0
GD300-045G-5		18.0	6.75	33.8	54.0	10.0
GD300-055G-5		14.7	8.25	41.3	66.0	10.0
GD300-075G-5		10.8	11.25	56.3	90.0	10.0

Note:

1. Select brake resistors according to the resistance and power data provided by our company.
2. The brake resistor may increase the brake torque of the VFD. The preceding table describes the resistance and power for 100% brake torque, 10% brake usage, 50% brake usage, and 80% brake usage. You can select the brake system based on the actual operation conditions.

3. When using an external brake unit, set the brake voltage class of the brake unit properly by referring to the manual of the dynamic brake unit. If the voltage class is set incorrectly, the VFD may not run properly.

	<ul style="list-style-type: none"> Never use a brake resistor with a resistance below the minimum value specified for the particular drive. The drive and the internal chopper are not able to handle the overcurrent caused by the low resistance.
	<ul style="list-style-type: none"> Increase the power of the braking resistor properly in the frequent braking situation (the frequency usage ratio is more than 10%).

D.8.1.3 AC 3PH 380V(-15%)–440V(+10%)



The VFDs of 660V need external braking units. Please select the braking resistor according to actual operation (such as the brake torque and brake usage requirements).

Model	Model of braking unit	Brake resistor value matched with 100% brake torque (Ω)	Dissipation power of brake resistor (kW) (10% brake)	Dissipated power of brake resistor (kW) (50% brake)	Dissipated power of brake resistor (kW) (80% brake)	Min allowed brake resistor (Ω)
GD300-022G-6	DBU100H-110-6	55	4	17	27	10.0
GD300-030G-6		40.3	5	23	36	
GD300-037G-6		32.7	6	28	44	
GD300-045G-6		26.9	7	34	54	
GD300-055G-6		22.0	8	41	66	
GD300-075G-6		16.1	11	56	90	
GD300-090G-6		13.4	14	68	108	
GD300-110G-6		11.0	17	83	132	
GD300-132G-6	DBU100H-160-6	9.2	20	99	158	6.9
GD300-160G-6		7.6	24	120	192	
GD300-185G-6	DBU100H-220-6	6.5	28	139	222	5.0
GD300-200G-6		6.1	30	150	240	
GD300-220G-6		5.5	33	165	264	
GD300-250G-6	DBU100H-320-6	4.8	38	188	300	3.4
GD300-280G-6		4.3	42	210	336	
GD300-315G-6		3.8	47	236	378	
GD300-350G-6		3.5	53	263	420	
GD300-400G-6	DBU100H-400-6	3.0	60	300	480	2.8
GD300-500G-6	Two	4.8×2	38×2	188×2	300×2	3.4×2

Model	Model of braking unit	Brake resistor value matched with 100% brake torque (Ω)	Dissipation power of brake resistor (kW) (10% brake)	Dissipated power of brake resistor (kW) (50% brake)	Dissipated power of brake resistor (kW) (80% brake)	Min allowed brake resistor (Ω)
GD300-560G-6	DBU100H-320-6	4.3×2	42×2	210×2	336×2	
GD300-630G-6		3.8×2	47×2	236×2	378×2	

Note:

1. Select brake resistors according to the resistance and power data provided by our company.
2. The brake resistor may increase the brake torque of the VFD. The preceding table describes the resistance and power for 100% brake torque, 10% brake usage, 50% brake usage, and 80% brake usage. You can select the brake system based on the actual operation conditions.
3. When using an external brake unit, set the brake voltage class of the brake unit properly by referring to the manual of the dynamic brake unit. If the voltage class is set incorrectly, the VFD may not run properly.

	<ul style="list-style-type: none"> • Never use a brake resistor with a resistance below the minimum value specified for the particular drive. The drive and the internal chopper are not able to handle the overcurrent caused by the low resistance.
	<ul style="list-style-type: none"> • Increase the power of the braking resistor properly in the frequent braking situation (the frequency usage ratio is more than 10%).

D.8.2 Selecting the brake resistor cables

Brake resistor cables need to be shielded cables.

D.8.3 Placing the brake resistor

All resistors need to be installed in places with good cooling conditions.

	<ul style="list-style-type: none"> • The materials near the brake resistor or brake unit must be non-flammable. The surface temperature of the resistor is high. Air flowing from the resistor is of hundreds of degrees Celsius. Prevent any materials from coming into contact with the resistor.
---	--

Installation of the braking resistor:

	<ul style="list-style-type: none"> • The VFDs of 380V (≤30kW) only need external braking resistors. • PB and (+) are the wiring terminals of the braking resistors.
---	---

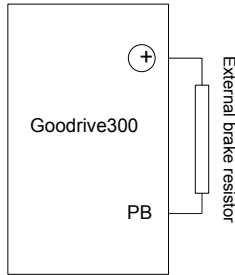

Installation of braking units:



- The VFDs of 380V ($\geq 37\text{kW}$) need external braking units.
- The VFDs of 660V need external braking units.
- (+), (-) are the wiring terminals of the braking units.
- The wiring length between the (+),(-) terminals of the VFD and the (+),(-) terminals of the braking units should be no more than 5m, and the distributing length among BR1 and BR2 and the braking resistor terminals should be no more than 10m.

Signal installation is as below:

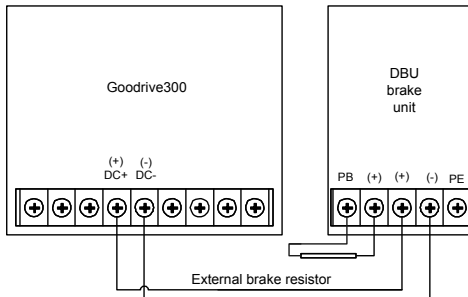

Appendix E Further information

E.1 Product and service queries

Should you have any queries about the product, contact the local INVT office. Provide the model and serial number of the product you query about. You can visit www.invt.com to find a list of INVT offices.

E.2 Feedback on INVT VFD manuals

Your comments on our manuals are welcome. Visit www.invt.com, directly contact online service personnel or choose **Contact Us** to obtain contact information.

E.3 Documents on the Internet

You can find manuals and other product documents in PDF format on the Internet. Visit www.invt.com and choose **Service and Support > Data Download**.



Service line:86-755-86312859 E-mail:overseas@invt.com.cn Website:www.invt.com

The products are owned by **Shenzhen INVT Electric Co.,Ltd.**

Two companies are commissioned to manufacture: (For product code, refer to the 2nd/3rd place of S/N on the name plate.)

Shenzhen INVT Electric Co., Ltd. (origin code: 01)

Address: INVT Guangming Technology Building, Songbai Road,
Matian, Guangming District, Shenzhen, China

INVT Power Electronics (Suzhou) Co., Ltd. (origin code: 06)

Address: 1# Kunlun Mountain Road, Science&Technology Town,
Gaixin District, Suzhou, Jiangsu, China

- Industrial Automation: ■ HMI ■ PLC ■ VFD ■ Servo System
- Elevator Intelligent Control System ■ Rail Transit Traction System
- Energy & Power: ■ UPS ■ DCIM ■ Solar Inverter ■ SVG
- New Energy Vehicle Powerstain System ■ New Energy Vehicle Charging System
- New Energy Vehicle Motor

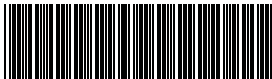

66001-00035

Copyright© INVT.

Manual information may be subject to change without prior notice.

201910 (V3.4)